



TW120

ROTARY CUTTER

Published 01/11

Part NO. 00762120C

OPERATOR'S MANUAL



This Operator's Manual is an integral part of the safe operation of this machine and must be maintained with the unit at all times. READ, UNDERSTAND, and FOLLOW the Safety and Operation Instructions contained in this manual before operating the equipment. C01-Cover

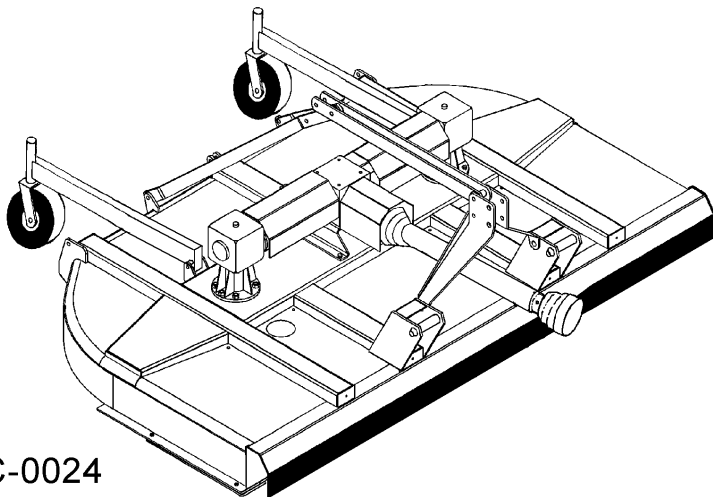

FC-0024

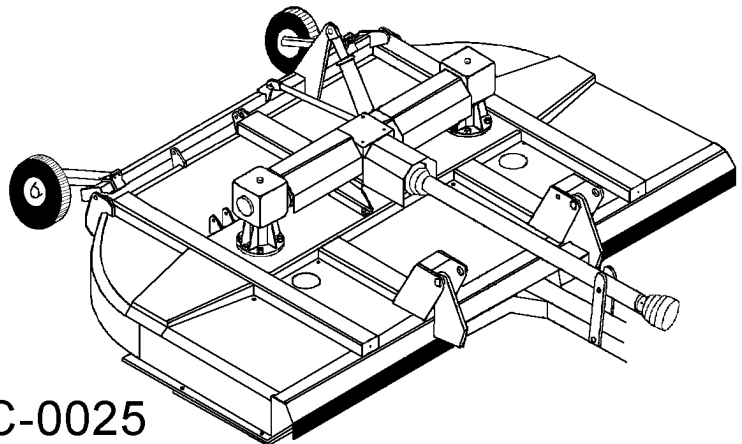

FC-0025

RHINO[®]

1020 S. Sangamon Ave.

Gibson City, IL 60936

800-446-5158

E-mail: parts@servis-rhino.com

¡ATENCIÓN!
LEA EL INSTRUCTIVO



Si No Lee Ingles, Pida
Ayuda a Alguien
Que Se Lo Lea Para Que le
Traduzca Las
Medidas de Seguridad

A MEMBER OF THE
ALAMO GROUP
ALWAYS ON THE CUTTING EDGE[®]

To the Owner/Operator/Dealer

This Operator's Manual is an integral part of the safe operation of this machine and must be maintained with the implement at all times. A Manual canister is provided on the implement where this manual can be properly stored. If you lose or damage this manual a free replacement manual can be obtained from an authorized Rhino dealer or by downloading the manual from the Rhino website www.servis-rhino.com

BEFORE YOU START! READ, UNDERSTAND, and FOLLOW the information provided in this manual, the AEM Mower Safety manual and the tractor operator's manual carefully to learn how to operate and service your machine properly. Failure to do so could result in personal injury to you and bystanders. All implements with moving parts are potentially hazardous. Every effort has been made to ensure that the machine is safe but operators must avoid engaging in unsafe practices and follow the written instructions provided. The manufacturer has designed this implement to be used with all its safety equipment properly attached to minimize the chance of accidents.

SAFETY FIRST. Completely read and understand the safety section of this manual before operating this equipment. Do not allow anyone to operate this equipment who has not fully read and understood this manual. Contact your Dealer to explain any instructions that you do not fully understand.

The care you give your Rhino Implement will greatly determine your satisfaction with its performance and its service life. Carefully read and follow the instructions in this manual to provide you with a thorough understanding of your new implement and its intended use and service requirements.

All references made in this manual to right, left, front, rear, top or bottom are as viewed facing the direction of forward travel with the implement properly attached to the tractor.

Replacement Parts information is located in a separate Parts Manual. Rhino mowers use balanced and matched system components for blade carriers, blades, cuttershafts, knives, knife hangers, rollers, drivetrain components, and bearings. These parts are made and tested to Rhino specifications. Non-genuine "will fit" parts do not consistently meet these specifications. The use of "will fit" parts may reduce mower performance, void warranties, and present a safety hazard. Use genuine Rhino mower parts for economy and safety.

For future reference, record your Rhino product model number and serial number.

Dealer		Telephone		Model Number	
Owner		Purchase Date:		Serial Number	



➤ **BE SAFE!**

➤ **BE ALERT!**

➤ **BE ALIVE!**

➤ **BE TRAINED**
before operating
the Mower!

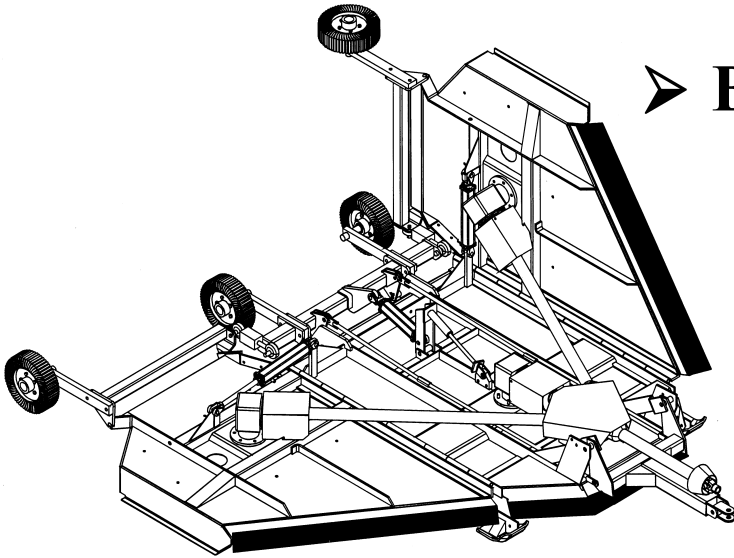

Safety Training Makes the Difference

In order to reduce accidents and enhance the safe operation of mowers, *Alamo Group Ag Division*, in cooperation with other industry manufacturers has developed the AEM/FEMA Industrial and Agricultural Mower Safety Practices video and guide book.

The video will familiarize and instruct mower-tractor operators in safe practices when using industrial and agricultural mowing equipment. It is important that Every Mower Operator be educated in the operation of their mowing equipment and be able to recognize the potential hazards that can occur while operating a mower. This video, along with the mower operator's manual and the warning messages on the mower, will significantly assist in this important education.

Your Authorized *Rhino* Dealer may have shown this video and presented you a DVD Video when you purchased your mower. If you or any mower operator have not seen this video, **Watch the Video, Read this Operator's Manual, and Complete the Video Guidebook** before operating your new mower. If you do not understand any of the instructions included in the video or operator's manual or if you have any questions concerning safety of operation, contact your supervisor, dealer or *Alamo Group Ag*.

If you would like a VHS video tape of the video, please email AEMVideo@alamo-group.com or Fax AEM VHS Video at (830) 372-9529 or mail in a completed copy of the form on the back of this page to AEM VHS Video 1502 E Walnut Street, Seguin, TX 78155. and request the VHS video version. Please include your name, mailing address, mower model and serial number.

Every operator should be trained for each piece of equipment (Tractor and Mower), understand the intended use and the potential hazards before operating the equipment.

The information and material listed above along with this Operator's Manual can assist you in meeting the OSHA requirement for Operator annual training.

OSHA TRAINING REQUIREMENTS

The following training requirements have been taken from Title 29, Code of Federal Regulations Part 1928.57 (a)(6). www.osha.gov

Operator Instructions. At the time of initial assignment and at least annually thereafter, the employer shall instruct every employee who operates an agricultural tractor or implement in the safe operating practices and servicing of equipment with which they are or will be involved, and of any other practices dictated by the work environment.

**Alamo Group Ag. Division will provide
one (1) AEM Mower Safety Practices Video**

- Please Send Me: VHS Format – AEM/FEMA Mower Operator Safety Video
 DVD Format – AEM/FEMA Mower Operator Safety Video
 Mower Operator’s Manual
 AEM Mower Operator’s Safety Manual

Requester Name: _____ Phone: _____

Requester Address: _____

City: _____

State: _____

Zip Code: _____

Mower Model: _____ Serial Number: _____

Date Purchased: _____ Dealer Salesperson: _____

Dealership Name: _____ Dealership Location: _____

Mail to:

AEM Video Services
1502 E. Walnut Street
Seguin, TX 78155

Or Fax to:

(830) 372-9529

Or E-mail to:

AEMVideo@alamo-group.com

AEM Mower Video

DEALER to CUSTOMER Pre-Delivery/ Operation Instructions

Dealer should inform the Purchaser of this product of Warranty terms, provisions, and procedures that are applicable. Dealer should inform Purchaser to review the contents of the Operator's Manual including safety equipment, safe operation and maintenance, to review the Safety Signs on the implement (and tractor if possible) and of Purchaser's responsibility to train his/her operators's of safe operation procedures.

- **IMPLEMENTS:** I have explained that Deflectors, Chain Guards, or Solid Skirts must be installed and maintained in good repair.
- **DRIVELINES:** I have made certain that all driveline, gearbox, and other shields are in good repair and fastened securely in place to prevent injuries from entanglement or thrown objects.
- **HYDRAULIC MACHINES:** I have explained the necessity of using clean hydraulic oil, changing filters as instructed, stopping leaks, damage caused by operating with over-heated oil, caring for hoses, using hoses of proper rating, maintaining the specified operating pressure and the potential hazard of oils penetrating the skin.
- **FOLDING-TYPE IMPLEMENTS:** I have explained that it is not possible to guard against thrown objects when the head is lifted off ground and that operator is responsible to watch out for persons in the area. I have explained that the lifted mower head or boom can contact overhead obstructions with damage to cables and telephone lines and possible injury. I have explained that the extended head or boom or retracted boom can contact power lines resulting in electrocution, injury or death and that operator is responsible for keeping clear of such hazards.

PRE-DELIVERY SERVICE

CHECK AND ADJUST OR LUBRICATE AS REQUIRED

See Operator's Manual for Details

Inspection Performed - Warranty and Safety Procedures Explained - Installation Complete

LUBRICATION & HYDRAULICS

- Gearbox (Oil Levels)
- Hydraulic Oil Level (External Tank)
- Tractor Hydraulic Oil Level
- Hydraulic Hoses (Not Kinked Tighten Connections)
- Front Pump Drive (Assembly Is Tight And Shaft Properly Aligned)

MOWER

- Spindle And Motor Bolts Properly Torqued
- Spindle Oil Level
- Blade Carrier Bolts Properly Torqued/Retaining Pin In Place
- Mower Cutting Height And Level Adjusted
- Cutting Shaft Bearings Lubricated
- All Hardware Properly Torqued
- Tire and Air Pressure/Lug Nuts (Correct Torque)
- Wheel Bearings (Check, Grease, and Preload)

ATTACHMENTS & INSTALLATION

- Deflectors Front And Rear
- Shredding Attachments
- Correct Blade Rotation Direction
- Axle Arms And Beams
- Tongue And Control Rods (Installed And Adjusted)
- All Bolts - Pins And Nuts (Proper Torque)

MOWER TO TRACTOR CONNECTIONS

- Draw Bar Length (Check And Set)
- A-Frame Pivot & Links
- Control Rods (Adjusted Equal)
- Axle Height (Adjusted)
- Cutting Height (Adjust)
- Mount Kit-Pre-Operation Check Complete
- Mower Wing (Adjust Level With The Center)
- Mower Wing (Check For Proper Raising Operation)
- C.V. Drivelines (Check Max Turn Radius)
- Pull Type Hitch (Height Adjustment)
- Mounting Hardware Properly Torqued

SAFETY ITEMS

- Protective Shields (Operation And Installation)
- Driveline Clutch (Torque Limiter) (Adjust And Run In)
- Safety Decals (Installed)
- Operator's Manual (Supplied)
- Tractor PTO Shield (Installed)
- S.M.V. Emblem (Installed If Needed)
- Tongue Jack (Installation and Operation)
- Safety Tow Chain (Installed)
- ADMA Driveline Safety Manual Supplied
- AEM Mower Safety Manual (Supplied in Canister)
- AEM Mower Safety Video has been shown to Purchaser

Table of Contents

SAFETY SECTION	1-1
GENERAL SAFETY INSTRUCTIONS AND PRACTICES	1-2
OPERATOR SAFETY	1-3
CONNECTION OR DISCONNECTING IMPLEMENT SAFETY	1-4
CRUSHING HAZARDS	1-5
THROWN OBJECTS HAZARDS	1-6
THROWN OBJECTS HAZARDS (CONTINUED)	1-7
RUN OVER HAZARDS	1-8
PTO ENTANGLEMENT HAZARDS	1-9
MOWER BLADE CONTACT HAZARDS	1-10
HIGH PRESSURE OIL LEAK HAZARDS	1-11
ELECTRICAL & FIRE HAZARDS	1-12
TRANSPORTING HAZARDS	1-13
HAZARDS WITH MAINTENANCE OF IMPLEMENT	1-14
PARTS INFORMATION	1-15
Decal Location - Lift Type	1-16
Decal Location - Pull Type	1-18
Decal Description	1-20
Federal Laws and Regulations	1-28
INTRODUCTION SECTION	2-1
Equipment Specifications	2-3
KEY OPERATION POINTS	2-4
Operating Noise Level/Sound Pressure	2-4
Warranty information	2-4
RHINO LIMITED WARRANTY	2-5
ASSEMBLY SECTION	3-1
DEALER SETUP INSTRUCTIONS	3-2
A-FRAME ASSEMBLY-LIFT TYPE	3-2
TAIL WHEEL ASSEMBLY - LIFT TYPE	3-4
TONGUE - PULL TYPE	3-4
AXLE ASSEMBLY - PULL TYPE	3-5
CONTROL RODS - PULL TYPE	3-5
CUTTER LEVELING	3-6
HYDRAULIC OR MANUAL LIFT	3-7
WHEELS - PULL TYPE	3-7
DRIVELINE ATTACHMENT	3-8
SHIELD ASSEMBLY	3-8
JACKSHAFT BEARING SUPPORT ASSEMBLY	3-9
CV JACKSHAFT SUPPORT ASSEMBLY	3-9
DRIVELINE CLAMP CONE YOKE OPERATING INSTRUCTIONS	3-10
FRONT AND REAR DEFLECTORS (Standard Equipment)	3-10
CHAIN GUARDS (Optional Equipment at extra cost)	3-10
Rear Deflector	3-11
CHAIN GUARD (EXTRA EQUIPMENT)	3-11
Front Chain Guards	3-11
Rear Chain Guards	3-12
CHECK CHAINS (EXTRA EQUIPMENT) FOR LIFT-MODELS	3-12
OPERATION SECTION	4-1
OPERATOR REQUIREMENTS	4-3
TRACTOR REQUIREMENTS	4-4

ROPS and Seat Belt	4-4
Tractor Safety Devices	4-5
Tractor Horsepower	4-5
3-Point Hitch	4-5
Drawbar-Pull Type Mower	4-6
Front End Weight	4-6
Power Take Off (PTO)	4-7
Tire Spacing	4-7
GETTING ON AND OFF THE TRACTOR	4-8
Boarding the Tractor	4-8
Dismounting the Tractor	4-8
STARTING THE TRACTOR	4-9
CONNECTING THE MOWER TO THE TRACTOR	4-10
Connecting the Mower-Lift Type and Semi-Mount Type	4-10
3-Point Quick Hitch	4-11
Connecting Mower - Lift Type (Quick Hitch)	4-11
Safety Tow Chain	4-12
Connecting the Mower-Pull Type	4-12
SETTING THE MOWER	4-13
Setting Mower Height- Lift Type	4-13
Setting Mowing Height-Pull Type	4-14
Setting Deck Pitch	4-15
DRIVELINE ATTACHMENT	4-15
Driveline Length Check	4-16
Constant Velocity (CV) Driveline	4-18
PRE-OPERATION INSPECTION AND SERVICE	4-19
Tractor Pre-Operation Inspection/Service	4-20
Mower Pre-Operation Inspection/Service	4-21
Cutting Component Inspection	4-24
Blade Bolt Inspection	4-26
DRIVING THE TRACTOR AND IMPLEMENT	4-29
Starting the Tractor	4-30
Brake and Differential Lock Setting	4-30
Raising the Mower	4-31
Driving the Tractor and Mower	4-31
Crossing Ditches and Steep Inclines	4-32
OPERATING THE TRACTOR AND IMPLEMENT	4-33
Foreign Debris Hazards	4-34
Bystanders/Passersby Precautions	4-34
Engaging the Power Take Off (PTO)	4-35
PTO RPM and Ground Speed	4-36
Operating the Mower	4-36
Right of Way (Highway) Mowing	4-39
Shutting Down the Implement	4-40
DISCONNECTING THE MOWER FROM THE TRACTOR	4-40
MOWER STORAGE	4-42
TRANSPORTING THE TRACTOR AND IMPLEMENT	4-42
Transporting on Public Roadways	4-43
Hauling the Tractor and Implement	4-45
TROUBLESHOOTING GUIDE	4-46
MAINTENANCE SECTION	5-1
HAZARDS WITH MAINTENANCE OF IMPLEMENT	5-2
Lubrication	5-3
GEARBOX	5-6
DRIVELINES	5-6
MAIN & JACKSHAFT DRIVELINE SHIELDS	5-8

MAIN CV DRIVELINE SAFETY SHIELD (FIGURE Mnt-R-0032)	5-9
DRIVELINE TAPER CONE YOKE REMOVAL INSTRUCTIONS	5-10
BLADE SERVICING	5-10
BLADE SHARPENING	5-11
BLADE CARRIER REMOVAL	5-11
BLADE REMOVAL	5-13
Blade Bolt Inspection	5-14
BLADE TIMING AND ROTATION	5-15
BLADE TIMING PROCEDURE	5-15
SLIP CLUTCH	5-16
STORAGE	5-17
PROPER TORQUE FOR FASTENERS	5-17

SAFETY SECTION

Safety Section 1-1

SAFETY

GENERAL SAFETY INSTRUCTIONS AND PRACTICES

A careful operator is the best operator. Safety is of primary importance to the manufacturer and should be to the owner/operator. Most accidents can be avoided by being aware of your equipment, your surroundings, and observing certain precautions. The first section of this manual includes a list of Safety Messages that, if followed, will help protect the operator and bystanders from injury or death. Read and understand these Safety Messages before assembling, operating or servicing this Implement. This equipment should only be operated by those persons who have read the manual, who are responsible and trained, and who know how to do so responsibly.



The Safety Alert Symbol combined with a Signal Word, as seen below, is used throughout this manual and on decals which are attached to the equipment. The Safety Alert Symbol means: "ATTENTION! BECOME ALERT! YOUR SAFETY IS INVOLVED!" The Symbol and Signal Word are intended to warn the owner/operator of impending hazards and the degree of possible injury faced when operating this equipment.

Practice all usual and customary safe working precautions and above all--- remember safety is up to YOU. Only YOU can prevent serious injury or death from unsafe practices.



Indicates an imminently hazardous situation that, if not avoided, WILL result in DEATH OR VERY SERIOUS INJURY.



Indicates an imminently hazardous situation that, if not avoided, COULD result in DEATH OR SERIOUS INJURY.



Indicates an imminently hazardous situation that, if not avoided, MAY result in MINOR INJURY.

Important

Identifies special instructions or procedures that, if not strictly observed, could result in damage to, or destruction of the machine, attachments or the environment.

NOTE: *Identifies points of particular interest for more efficient and convenient operation or repair.*

READ, UNDERSTAND, and FOLLOW the following Safety Messages. Serious injury or death may occur unless care is taken to follow the warnings and instructions stated in this Manual and in the Safety Messages on the implement. Always follow the instruction in this manual and use good common sense to avoid hazards.



NOTE: *If you want a translation of this safety section in one of the following Languages, please contact: Translations at 1502 E. Walnut Street Seguin, TX 78155; Fax: (830) 372-9529; Safety Section Translations are available in Spanish, Portuguese, French, German, Russian. PN GS01*

SAFETY

OPERATOR SAFETY

				
Read and understand Operator's Manual	Always wear Safety Glasses	Wear Hard Hat Safety Shoes	Never use Drugs or Alcohol when operating equipment	Wear Safety Vest when operating on or near roads



TO AVOID SERIOUS INJURY OR DEATH DO THE FOLLOWING:

- **READ, UNDERSTAND** and **FOLLOW** Operator's Manual instructions, Warnings and Safety Messages.
- **WEAR SAFETY GLASSES**, safety shoes, hard hat, hearing protection and gloves when operating or repairing equipment
- **WEAR** appropriate breathing respirator when operating in dusty conditions to avoid respiratory diseases.
- **DO NOT WEAR** loose clothing or jewelry to avoid rotating parts entanglement injury.
- **DO NOT USE DRUGS** or **ALCOHOL** before or while operating equipment.
- **DO NOT ALLOW** anyone to operate equipment under the influence of drug or alcohol.
- **CONSULT** medical professional for medication impairment side effects.
- **STAY ALERT**, prolonged operation can cause fatigue, **STOP** and **REST**.

GENERAL OPERATING SAFETY

VISIBILITY CONDITIONS WHEN MOWING:

- **OPERATE IN DAYLIGHT** or with lights that gives at least 100 yards clear visibility.
- **BE ABLE TO SEE** and identify passersby, steep slopes, ditches, drop-offs, overhead obstructions, power lines, debris and foreign objects.

GROUND SPEED WHEN MOWING:

- **NORMAL SPEED** range is between 2 to 5mph.
- **ADJUST MOWING SPEED** for terrain conditions and grass type, density and cut height.
- **REDUCE MOWING SPEED** when near steep slopes, ditches, drop-offs, overhead obstructions, power lines and to avoid debris and foreign objects.

INSECT INFESTATION

- Do Not operate in areas where bees or insects may attack unless you **WEAR PROTECTIVE CLOTHING** or use enclosed tractor cab.

PTO SPEED:

- **DO NOT EXCEED IMPLEMENT RATED PTO SPEED**
- **AVOID** exceeding rated PTO speeds that may result in broken drivelines or blade failures.

SAFETY SIGNS:

- **REPLACE** missing, damaged or unreadable safety signs immediately. *PN OS01*

SAFETY

CONNECTION OR DISCONNECTING IMPLEMENT SAFETY

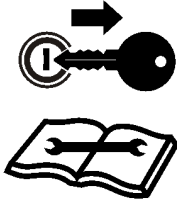
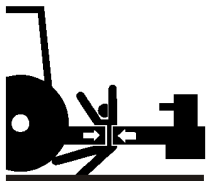
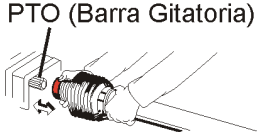
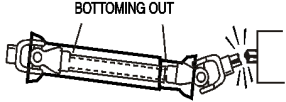
			
<p>Stop Tractor Remove Key Read Manual</p>	<p>Crushing injury between tractor and implement</p>	<p>Make sure PTO shaft is securely attached to tractor</p>	<p>Make sure PTO shaft are proper length</p>



TO AVOID SERIOUS INJURY OR DEATH FROM BEING CRUSHED BY TRACTOR OR IMPLEMENT:

WHEN BACKING tractor to implement hitch:

- **DO NOT ALLOW BYSTANDERS** between tractor and implement

BEFORE connecting and disconnecting implement hitch:

- **STOP TRACTOR ENGINE**, place transmission into park, engage parking brake and remove key.

WHEN connecting and disconnecting implement hitch:

- **DO NOT** crawl or walk under raised mower or wing.
- **USE** tongue **JACK** to lift heavy implement tongues to control implement tongue movement.
- **AVOID** overloading jack to prevent jack failure and injury.

WHEN CONNECTING IMPLEMENT DRIVELINE:

TO AVOID implement driveline coming loose during operation:

- **LUBRICATE** yoke spring locking collar to ensure it freely slides on PTO shaft
- **SECURELY** seat yoke locking balls in PTO shaft groove.
- **PUSH** and **PULL DRIVELINE** on both the tractor and implement **PTO SHAFTS** to ensure it is **SECURELY ATTACHED**

TO AVOID broken driveline during operations:

- **CHECK** driveline for proper length between PTO shaft and implement gearbox shaft.
- Drivelines too short can pull apart or disengage.
- Drivelines too long can bottom out.
- Bottoming driveline telescoping assembly will stop sliding and become solid.
- Driveline bottoming can push through support bearings and break off PTO shaft.

CONTACT DEALER if implement driveline does not match Tractor PTO shaft:



- **DO NOT USE PTO ADAPTER.**
Using a PTO adapter can cause:
 - Excessive vibration, thrown objects, blade and implement failures by doubling operating speed.
 - Increased working length exposing unshielded driveline areas and entanglement hazards.

DO NOT connect the Mower to a tractor with the PTO directly connected to the Tractor transmission. PN CD02

SAFETY

SAFETY

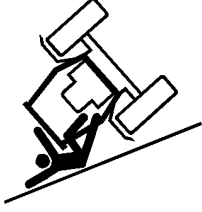
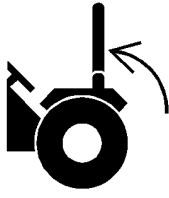
CRUSHING HAZARDS

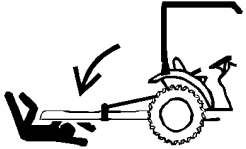
			
Crushing injury from roll over	Lock ROPS in up position	Always wear seatbelt	Crushing injury implement falling



TO AVOID SERIOUS INJURY OR DEATH FROM FALLING OFF TRACTOR, EQUIPMENT RUN OVER, ROLLOVER AND CRUSHING BY FALLING WING OR IMPLEMENT:

- **USE ROPS** and **SEAT BELT** equipped tractors for mowing operations.
- **KEEP ROPS** lock in up position.
- **ALWAYS BUCKLE UP** seat belt when operating tractor and equipment.
- **ONLY OPERATE** tractor and equipment while seated in tractor seat.

WHEN RAISING OR LOWERING IMPLEMENT:

- Raise or lower **ONLY WHILE SEATED** in tractor seat with seat belt buckled.
- Raise or lower **ONLY** when implement tongue is securely attached to tractor drawbar **TO AVOID** implement tip over.
- **KEEP BYSTANDERS CLEAR** of area **TO AVOID** crushing.

LIFTED Equipment can fall from mechanical or hydraulic failure or inadvertent Control Lever movement.



TO AVOID EQUIPMENT FALLING while working near or under lifted wings, components and implements raised by 3-Pointed tractor hitch:

- **SECURELY SUPPORT** or **block up** raised equipment and components.
- **BLOCK UP** and **securely support** equipment before putting hands, feet or body under raised equipment or lifted components.

WHEN PARKING Implement and Tractor:

- **LOWER** implement, **LOCK** or **BLOCK** lifted parts before leaving equipment.
- **NEVER** leave implement unattended in a raised position.



TO AVOID CHILDREN FALLING OFF OR BEING CRUSHED BY EQUIPMENT:



- **NEVER ALLOW** children to play on or around Tractor or Implement.

WHEN UNHITCHING IMPLEMENT:

- **LOWER** implement, **LOCK** or **BLOCK** lifted parts before leaving equipment.
- **USE** tongue jack to control implement tongue movement.
- **USE** tongue **JACK** to lift heavy implement tongues.
- **AVOID** overloading jack to prevent jack failure and injury. *PN CH02*

SAFETY

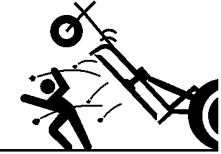
THROWN OBJECTS HAZARDS

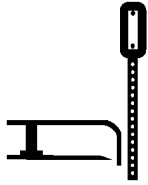
			
Mower Thrown Objects Hazard	Raised Mower Thrown Objects	Inspect Area remove foreign objects	Do not let blades contact solid objects



ROTARY MOWERS CAN THROW OBJECTS 300 FEET OR MORE UNDER ADVERSE CONDITIONS.

TO AVOID SERIOUS INJURY OR DEATH TO OPERATOR OR BYSTANDERS FROM THROWN OBJECTS:

- KEEP bystanders 300 feet away

STOP MOWING IF PASSERSBY ARE WITHIN 300 FEET UNLESS:

- **All THROWN OBJECT SHIELDING** including, Front and Rear Deflectors, Chains Guards, Steel Guards, Bands, Side Skirts and Skid Shoes in place and in good condition when mowing.
- Mower sections or wing are adjusted to be close and parallel to ground without exposing blades.
- **MOWING AREA** has been inspected and foreign materials and debris have been removed.
- **PASSERSBY** are inside enclosed vehicle.

INSPECT AREA FOR POTENTIAL THROWN OBJECTS BEFORE MOWING:

- **REMOVE** debris, rocks, wire, cable, metal objects and other foreign material from area. Wire, cable, rope, chains and metal objects can be thrown or swing outside deck with great velocity:
 1. **MARK** objects that cannot removed.
 2. **AVOID** these objects when mowing.

HIGH GRASS and WEED AREA INSPECTION:

- **INSPECT** for and **REMOVE** any hidden large debris.
- **MOW** at Intermediate height
- **INSPECT** and remove remaining debris
- **MOW** at final height.

MOWER THROWN OBJECT SHIELDING:



- **KEEP** all thrown object shielding including, Front and Rear Deflectors, Chains Guards, Steel Guards, Bands, Side Skirts and Skid Shoes in place and in good condition when mowing.
- **DO NOT OPERATE** with any thrown object shielding missing, damaged or removed.

RIGHT OF WAY (Highway) MOWING

- **USE DOUBLE CHAIN GUARDS** for highway, right-of-way, parks or greenbelt mowing or all other mowing where human dwellings, vehicles, or livestock could be within 300 feet of the mower.
- No shielding is 100% effective in preventing thrown objects. To Reduce Possibility of Injury:
 1. **MAINTAIN MOWER SHIELDING**, side skirts, skid shoes, and blades in good operational condition,
 2. **RAISE CUTTING HEIGHT** to **6 INCHES** minimum,
 3. **INSPECT AREA** thoroughly before mowing to **REMOVE** potential **THROWN OBJECT HAZARDS**,
 4. **NEVER ALLOW BLADES to CONTACT SOLID OBJECTS** like wire, rocks, post, curbs, guardrails, or ground while mowing. *PN T002*

SAFETY

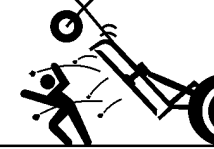
THROWN OBJECTS HAZARDS (CONTINUED)

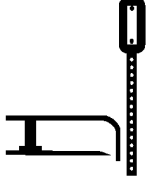
			
<p>Mower Thrown Objects Hazard</p>	<p>Raised Mower Thrown Objects</p>	<p>Inspect Area remove foreign objects</p>	<p>Do not let blades contact solid objects</p>

MOWER OPERATION:

- **DO NOT** exceed mower's rated Cutting Capacity or cut non-vegetative material.
- **USE ENCLOSED TRACTOR CABS** when two or more mowers are operating in mowing area.
- **ADJUST** mower sections or wing close and parallel to ground without exposing blades
- **ADJUST** cutting **HEIGHT** to **AVOID BLADE CONTACT** with solid objects like wire, rocks, posts, curbs, guard rails and fixed obstructions.
- **DO NOT** operate mower when mower is raised or in transport position
- **STOP MOWING** immediately if blades strike heavy objects, fixed structures, metal guard rails and concrete structures:
 1. **BLADES CAN FAIL** from impact and objects can be thrown with great velocity.
 2. **INSPECT** and **REPLACE** any damaged blades.
 3. **CHECK** blade carrier balance and **REPLACE** if damaged.
- **DO NOT** mow in standing water **TO AVOID** possible **BLADE FAILURE**.
- **AVOID MOWING** in reverse:
 1. **STOP PTO** and back up mower.
 2. **LOWER** mower, engage **PTO** and mow forward.
- **STOP PTO** and **BLADES** when raising implement or the mower to transport position.
- **DO NOT ENGAGE PTO** with mower in transport position.
- **STOP** mowing when **EXCESSIVE VIBRATION** occurs:
 1. **STOP PTO** and tractor **ENGINE**.
 2. **INSPECT** mower for vibration source
 3. **REPLACE** any damage parts and bent or damaged **BLADES**. *PN T002-X*

SAFETY

RUN OVER HAZARDS

		
Operator run over hazard	Rider fall off run over hazard	Rider fall off run over hazard

⚠ DANGER TO AVOID SERIOUS INJURY OR DEATH FROM FALLING OFF TRACTOR OR EQUIPMENT RUN OVER:

- **USE ROPS** and **SEAT BELT** equipped tractors for mowing operations.
- **KEEP ROPS** locked in **UP** position.
- **ONLY** start tractor while seated in tractor seat.
- **ALWAYS BUCKLE UP** seat belt when operating tractor and equipment.
- **ONLY OPERATE** tractor and equipment while seated in tractor seat.
- **NEVER ALLOW RIDERS** on tractor or implement.

WHEN MOUNTING AND DISMOUNTING TRACTOR:

- **ONLY** mount or dismount when tractor and moving parts are stopped.
- **STOP ENGINE AND PTO**, engage parking brake, lower implement, allow all moving parts to stop and remove key before dismounting from tractor. *PN R001*

SAFETY

SAFETY

PTO ENTANGLEMENT HAZARDS

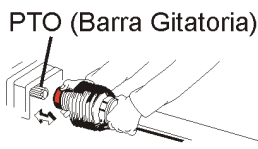
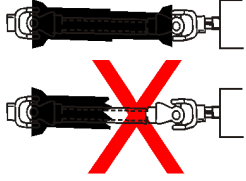
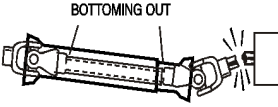
	 <p>PTO (Barra Gitatoria)</p>		 <p>BOTTOMING OUT</p>
<p>Entanglement hazard Do Not approach or touch a rotating PTO driveshaft</p>	<p>Make sure PTO shaft is securely attached Do Not Use PTO Adapter</p>	<p>DO NOT Operate if PTO shields are damaged or missing</p>	<p>Make sure PTO shafts are proper length</p>



KEEP AWAY FROM ROTATING DRIVELINES AND ELEMENTS TO AVOID SERIOUS INJURY OR DEATH:

STAY AWAY and **KEEP** hands, feet and body **AWAY** from rotating blades, drivelines and parts until all moving elements have stopped.

- **STOP, LOOK** and **LISTEN** before approaching the mower to make sure all rotating motion has stopped.
- **ROTATING COMPONENTS CONTINUE** to **ROTATE** after the PTO is shut off.

PTO SHIELDING:

TO AVOID SERIOUS INJURY OR DEATH FROM ENTANGLEMENT WHEN OPERATING IMPLEMENT:

- **KEEP PTO** shields, integral driveline shields and input shields installed
- **DO NOT OPERATE** mower without shields and guards in place or missing
- **REPAIR OR REPLACE** if damage, broken or missing
- **ALWAYS REPLACE GUARDS** that have been removed for service or maintenance.
- Do Not use PTO or PTO guard as a step.

TO AVOID broken driveline during operations:

- **CHECK** driveline for proper length between PTO shaft and implement gearbox shaft. *(Refer to Instructions in Operation Section)*
- Drivelines too short can pull apart or disengage.
- Drivelines too long can bottom out.
Bottoming driveline telescoping assembly will stop sliding and become solid.
- Driveline bottoming can push through support bearings and break off PTO shaft
- **AVOID** sharp turns or lift mower to heights to cause driveline "knocking".
- Lubricate driveshaft-telescoping components weekly.



CONTACT DEALER if implement driveline does not match Tractor PTO shaft:

- **DO NOT USE PTO ADAPTER.**

Using a PTO adapter can cause excessive vibration, thrown objects, blade and implement failures by doubling operating speed. Increased working length exposing unshielded driveline areas. **PN PE01**

SAFETY

MOWER BLADE CONTACT HAZARDS

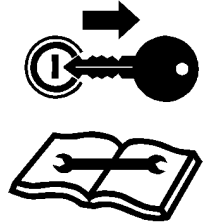
		
Do not put fingers underneath mower	Do not put foot underneath mower	Stop Tractor Remove Key Read Manual

⚠ DANGER



KEEP AWAY FROM ROTATING BLADES TO AVOID SERIOUS INJURY OR DEATH FROM BLADE CONTACT:

- **STAY AWAY** and **KEEP HANDS, FEET** and **BODY AWAY** from rotating blades, drivelines and parts until all moving elements have stopped.
- **DO NOT** put hands or feet under mower decks
- **STOP** rotating **BLADES** disengage PTO and wait for blade to stop rotating before raising mower deck or wings
- **STOP LOOK** and **LISTEN** before approaching the mower to make sure all rotating motion has stopped. *PN MB01*

SAFETY

SAFETY

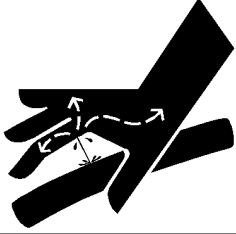
HIGH PRESSURE OIL LEAK HAZARDS

		
High pressure oil penetrating skin	High pressure oil eroding skin	Using cardboard to check for oil leaks



TO AVOID SERIOUS INJURY OR DEATH FROM HIGH PRESSURE HYDRAULIC OIL LEAKS PENERATING SKIN:

- **DO NOT OPERATE** equipment with oil or fuel leaks.
- **KEEP** all hydraulic hoses, lines and connections in **GOOD CONDITION** and **TIGHT** before applying system pressure.
- **RELIEVE HYDRAULIC PRESSURE** before disconnecting lines or working on the system.
- **REMOVE** and replace hose if you suspect it leaks. Have dealer test it for leaks.

HIGH PRESSURE FLUID LEAKS CAN BE INVISIBLE.

WHEN CHECKING FOR HYDRAULIC LEAKS AND WORKING AROUND HYDRAULIC SYSTEMS:

- **ALWAYS WEAR** safety glasses and impenetrable gloves.
- **USE** paper or cardboard to search for leaks.
- **DO NOT USE** hands or body parts to search for leak.
- **KEEP** hands and body **AWAY** from pin holes and nozzles ejecting hydraulic fluid.
- Hydraulic fluid may cause gangrene if not surgically removed immediately by a doctor familiar with this form of injury.

PN HP01

SAFETY

SAFETY

ELECTRICAL & FIRE HAZARDS

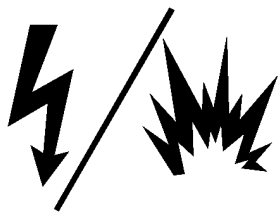

Strike and explosion Hazard
Blades Contacting Utility or
Gas Lines

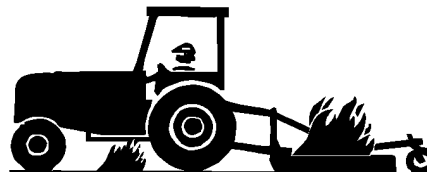

Do not operate near fires.
Keep mower deck clear of
debris



TO AVOID SERIOUS INJURY OR DEATH FROM ELECTRICAL CONTACT WHEN WORKING AROUND ELECTRICAL POWER LINES, GAS LINES AND UTILITY LINES:





- **INSPECT** mowing area for overhead or underground electrical power lines, obstructions, gas lines, cables and Utility, Municipal, or other type structure.
- **DO NOT** allow mower to contact with any Utility, Municipal, or type of structures and obstructions.
- **CALL 811** and 1-800-258-0808 for identify buried utility lines.

FIRE PREVENTION GUIDELINES while Operating, Servicing, and Repairing Mower and Tractor to reduce equipment and grass fire Risk:

- **EQUIP** Tractor with a **FIRE EXTINGUISHER**
- **DO NOT OPERATE** mower on a tractor equipped with under frame exhaust
- **DO NOT SMOKE** or have open flame near Mower or Tractor
- **DO NOT DRIVE** into burning debris or freshly burnt area
- **AVOID FIRE IGNITION** by not allowing mower blade to contact solid objects like metal or rock.
- **ADJUST SLIP CLUTCHES** to avoid excessive slippage and clutch plate heating.
- **CLEAR** any grass clippings or debris buildup around mower drivelines, slip clutches, and gearboxes.
- **SHUT OFF ENGINE** while refueling. *PN EF02*

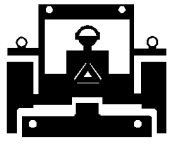
SAFETY

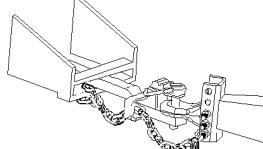
TRANSPORTING HAZARDS

				
Use SMV signs and Flashing Lights	Loss of Control Stopping Hazard	Loss of Control Speeding Hazard	Use Safety Tow Chain - Tractor to Implement	Engage Transport Locks

⚠ WARNING

TO AVOID SERIOUS INJURY AND DEATH WHEN TOWING OR TRANSPORTING EQUIPMENT:

- **KEEP** transport speed **BELOW** 20 mph to maintain control of equipment.
- **REDUCE SPEED** on inclines, on turns and in poor towing conditions.
- **DO NOT TOW** with trucks or other vehicles
- **USE** only properly sized and equipped tractor for towing equipment.
- **FOLLOW** all local traffic regulations.

TRACTOR REQUIREMENTS FOR TOWING OR TRANSPORTING IMPLEMENTS:

- **ONLY TRANSPORT** with tractor with **ROPS** in the raised position.
- **USE** properly sized and equipped tractor that exceeds implement weight by at least 20%
- **KEEP** 20% of tractor weight on front wheels to maintain safe steering.

BEFORE TRANSPORTING OR TOWING IMPLEMENT:

TRACTOR INSPECTION:

- **CHECK** steering and braking for proper operation and in good condition.
- **CHECK SMV** sign, reflectors and warning lights for proper operation and visibility behind unit.
- **CHECK** that your driving vision is not impaired by tractor, cab, or implement while seated in tractor seat.
- **ADJUST** your operating position, mirrors, and implement transport for clear vision for traveling and traffic conditions.

PREPARE IMPLEMENT FOR TRANSPORTING OR TOWING:

- **DISENGAGE PTO**
- **RAISE MOWER**
- **REMOVE** any cut material collected on mower deck.

TOWED MOWERS - ENGAGE TRANSPORT LOCKS AND SAFETY CHAINS:

- **INSTALL** center axle cylinder transport stops or pins
- **ATTACH** implement **SAFETY CHAIN** to tractor

DETERMINE STOPPING CHARACTERISTICS OF TRACTOR AND IMPLEMENT FOR TRANSPORTING OR TOWING:

BRAKING TESTS:

- **APPLY** brakes at increasing speeds
- Observe **STOPPING** distances increases with increased speeds.
- **DETERMINE** the maximum safe transport speed that does not exceed 20 mph

DETERMINE MAXIMUM TURNING SPEED BEFORE OPERATING ON ROADS OR UNEVEN GROUND:



- **TEST** equipment in slowly increasing speed in turns to determine it can be operated at higher speeds.
- **USE REDUCED** turning speeds in sharp turns to avoid equipment turning over.

WHEN TOWING OR TRANSPORTING EQUIPMENT:

- Always **WEAR SEAT BELT** when operating or transporting mower.
- **USE** low speeds to avoid overturn with raised wings.
- **USE** low speeds and gradual steering on curves, hills, rough or uneven surfaces and on wet roads
- **TURN ON** tractor **FLASHING WARNING LIGHTS**.
- **ALLOW** clearance for implement swing while turning. *PN TH02*

SAFETY

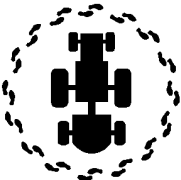
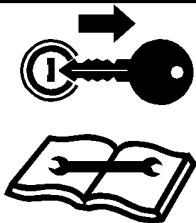
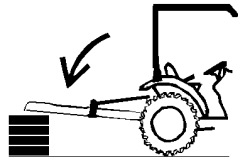
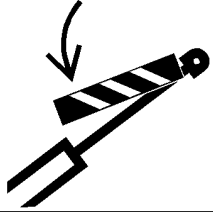
HAZARDS WITH MAINTENANCE OF IMPLEMENT

				
Periodically inspect all moving parts, lubricate drivelines, and tighten all fasteners	Stop engine remove key before conducting maintenance	Block up implement before servicing Use large blocks on soft or wet soil	Engage cylinder transport locks	Inspect Blades for damage or cracks

⚠ WARNING AVOID SERIOUS INJURY OR DEATH FROM COMPONENT FAILURE BY KEEPING IMPLEMENT IN GOOD OPERATING CONDITION IN PERFORMING PROPER SERVICE, REPAIRS AND MAINTENANCE.

BEFORE PERFORMING SERVICE, REPAIRS AND MAINTENANCE ON THE IMPLEMENT:

- **STOP ENGINE AND PTO**, engage parking brake, lower implement, allow all moving parts to stop and remove key before dismounting from tractor.
- **PLACE** implement on ground or securely block up raised equipment. Use large blocks on soft or wet soil.
- **PUSH** and **PULL** Remote Hydraulic Cylinder lever to relieve hydraulic pressure.
- **DISCONNECT IMPLEMENT** driveline from tractor **PTO SHAFT**.

WEAR SAFETY GLASSES, PROTECTIVE GLOVES and follow **SAFETY PROCEDURES** when performing service, repairs and maintenance on the implement:

- Always **WEAR** protective **GLOVES** when handling blades, knives, cutting edges or worn component with sharp edges.
- Always **WEAR GLOVES** and **SAFETY GLASSES** when servicing hot components
- **AVOID CONTACT** with hot hydraulic oil tanks, pumps, motors, valves and hose connection surfaces.
- **SECURELY** support or **BLOCK UP** raised implement, framework and lifted components before working underneath equipment.
- **STOP** any implement movements and **SHUT-OFF TRACTOR** engine before doing any work procedures.
- **USE** ladder or raised stands to reach high equipment areas inaccessible from ground.
- **ENSURE** good footing by standing on solid flat surfaces when getting on implement to perform work.
- **FOLLOW** manufacturer's instructions in handling oils, solvents, cleansers, and other chemical agents.
- **DO NOT** change any factory-set hydraulic calibrations to avoid component or equipment failures.
- **DO NOT** modify or alter implement, functions or components.
- **DO NOT WELD** or repair rotating mower components. These may cause vibrations and component failures being thrown from mower.

PERFORM SERVICE, REPAIRS, LUBRICATION AND MAINTENANCE OUTLINED IN IMPLEMENT MAINTENANCE SECTION:

- **INSPECT** for loose fasteners, worn or broken parts, leaky or loose fittings, missing or broken cotter keys and washers on pins, and all moving parts for wear.
- **REPLACE** any worn or broken parts with authorized service parts.
- **LUBRICATE** unit as specified by lubrication schedule
- **NEVER** lubricate, adjust or remove material while it is running or in motion.
- **TORQUE** all bolts and nuts as specified.

BLADE INSPECTION:

- **REPLACE** bent, damage, cracked or broken blades immediately with new blades.
- **AVOID** blade failures and thrown broken blades. **DO NOT** straighten, weld, or weld hard-facing blades.

SAFETY SHIELDS, GUARDS AND SAFETY DEVICES INSPECTION:

- **KEEP** all Deflectors, Chain Guards, Steel Guards, Gearbox Shields, and PTO integral shields, Bands, Side Skirts and Skid Shoes in place and in good condition.
- **REPLACE** any missing, broken or worn safety shields, guards and safety devices.
- Engine Exhaust, some of its constituents, and certain vehicle components contain or emit chemicals known to the state of California to cause cancer, birth defects or other reproductive harm.
- Battery posts, terminals and related accessories contain lead and lead compounds, chemicals known to the state of California to cause cancer, birth defects or other reproductive harm. **PN HM01**

SAFETY

PARTS INFORMATION

PARTS INFORMATION

Rhino mowers use balanced and matched system components for blade carriers, blades, cuttershafts, knives, knife hangers, rollers, drivetrain components, and bearings. These parts are made and tested to Rhino specifications. Non-genuine "will fit" parts do not consistently meet these specifications. The use of "will fit" parts may reduce mower performance, void warranties, and present a safety hazard. Use genuine Rhino mower parts for economy and safety. (SPRM-1)

SEE YOUR RHINO DEALER

SAFETY

SAFETY

SAFETY

Decal Location - Lift Type

NOTE: Rhino supplies safety decals on this product to promote safe operation. Damage to the decals may occur while in shipping, use, or reconditioning. Rhino cares about the safety of its customers, operators, and bystanders, and will replace the safety decals on this product in the field, free of charge (Some shipping and handling charges may apply). Contact your Rhino dealer to order replacement decals.

LIFT TYPE

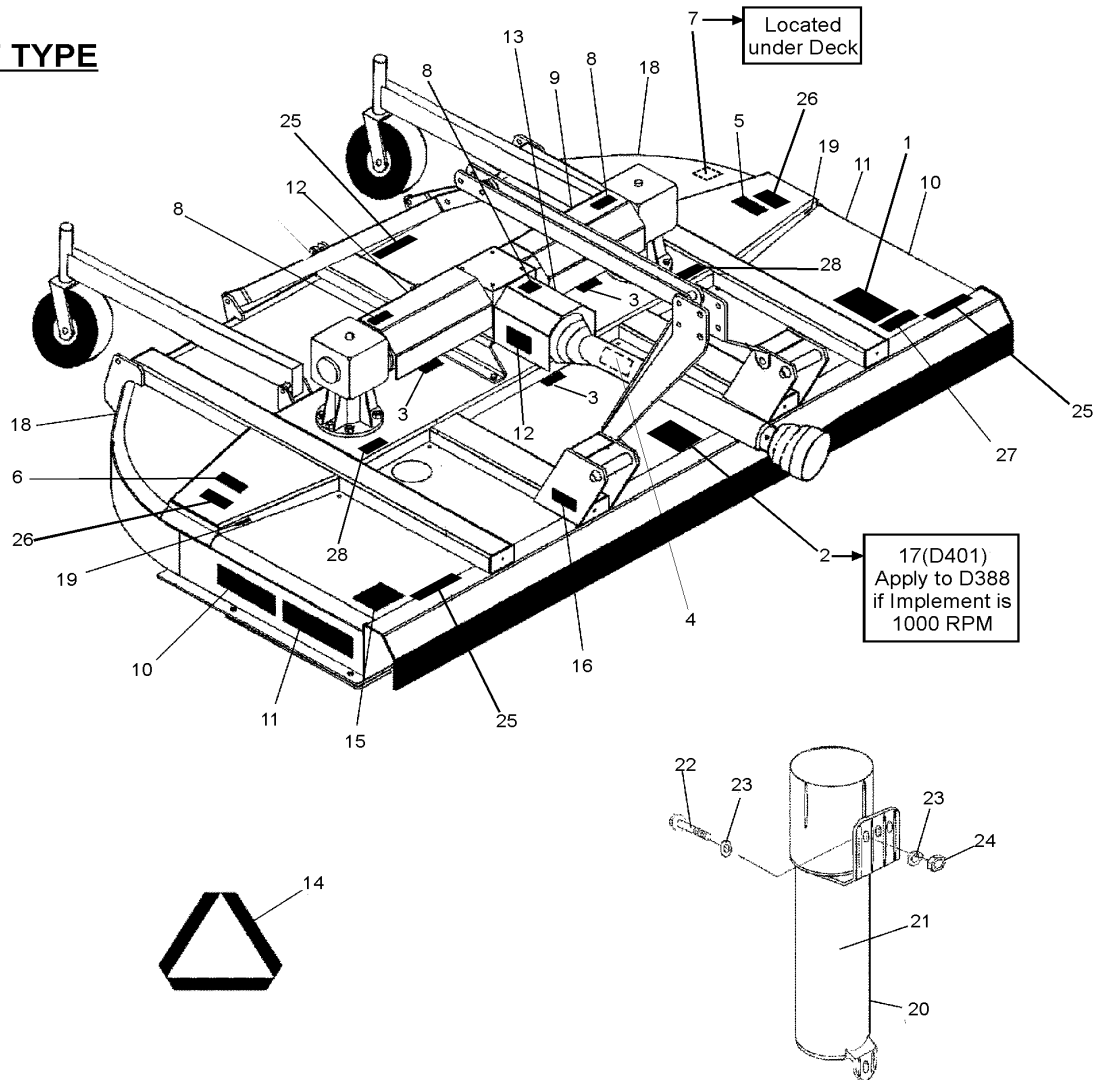

DL-R-0172

SAFETY

SAFETY

ITEM	PART NO.	QTY	LEVEL	DESCRIPTION
1.	D389	1	DECAL	Multi Hazard
2.	D388	1	DECAL	Driveline Hazards
3.	00756004	3	DANGER	D/L Shield Missing. Do Not Operate
4.	00756005	(2)	DANGER	Rotating D/L Entanglement
5.	D137	1	INSTRUCT	CCW Blade Rotation
6.	D138	1	INSTRUCT	CW Blade Rotation
7.	D454	1	WARNING	Crushing Hazard (Decal under Deck)
8.	00771283	3	INSTRUCT	5 Year Gearbox Warranty
9.	99102	1	NAME	Rhino (2.8" x 10")
10.	00787406	2	NAME	Rhino Type
11.	00785891	2	NAME	TW120 (Large)
12.	00785892	1	NAME	TW120 (Small)
13.	D302	2	LOGO	Rhino Logo (4-7/8 x 6-1/2)
14.	03200347	*	REFLECTOR	SMV Sign
15.	00760657	1	IMPORTANT	Rhino Genuine Parts, Rotary Mower
16.	nfs	1	SER PLT	Serial Number Plate
17.	D401	1	INSTRUCT	1000 RPM Overlay
18.	1458392	2	REFLECTOR	Red Reflectors
19.	1458393	2	REFLECTOR	Amber Reflectors
20.	00776031	1	-----	Canister, Operator's Manual
21.	00762120C	1	-----	Operator's Manual
22.	10058000	3	-----	Bolt
23.	00024100	6	-----	Flatwasher
24.	02959924	3	-----	Locknut
25.	D614	3	DANGER	Thrown Object Shield Missing
26.	D534	2	WARNING	Blade Bolt Torque
27.	D629	1	INSTRUCT	Lubrication Chart
28.	D608	2	WARNING	Blade Timing

* Provided by Tractor Manufacturer

(-) Provided by Driveline Manufacturer

DECAL SHEETS

Dual Spindle Decal Sheet D442

TW 120 Decal Sheet D483

SAFETY

SAFETY

Decal Location - Pull Type

NOTE: Rhino supplies safety decals on this product to promote safe operation. Damage to the decals may occur while in shipping, use, or reconditioning. Rhino cares about the safety of its customers, operators, and bystanders, and will replace the safety decals on this product in the field, free of charge (Some shipping and handling charges may apply). Contact your Rhino dealer to order replacement decals.

PULL TYPE

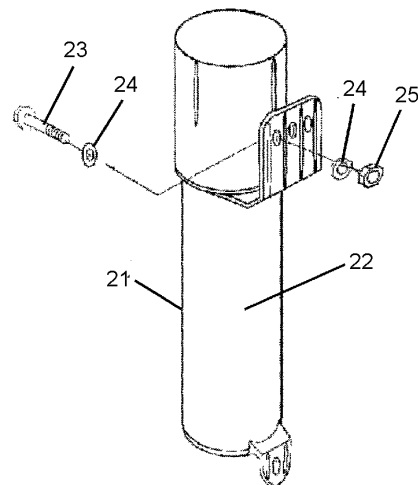
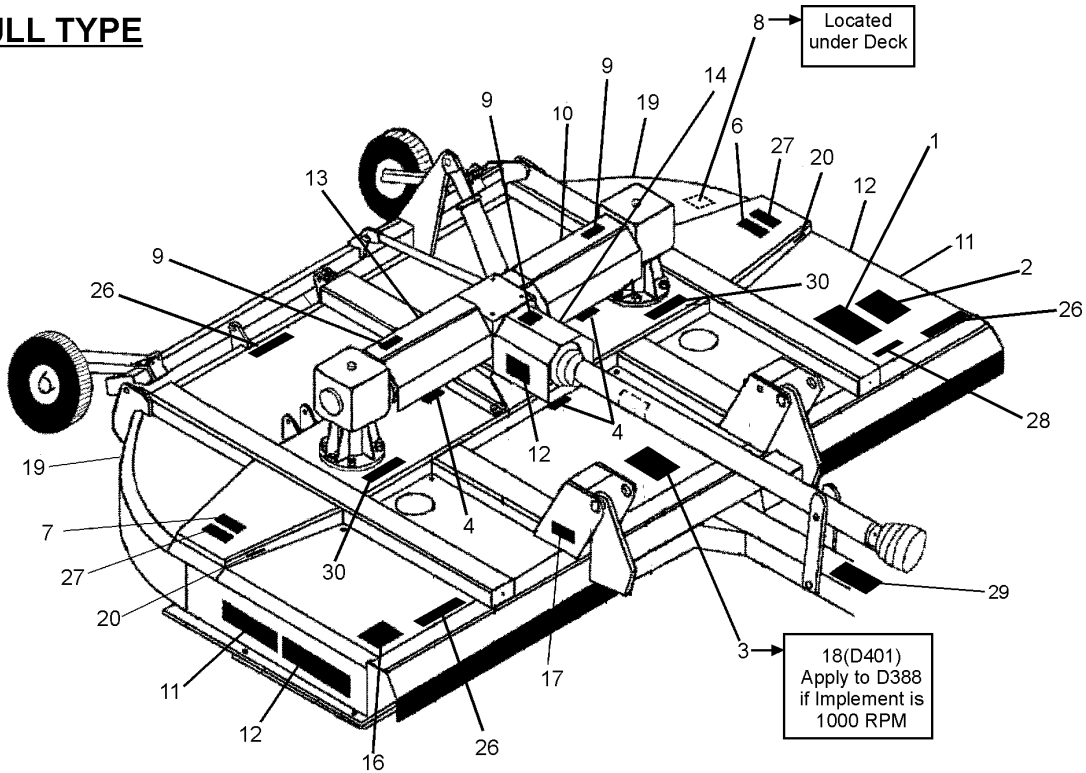

DL-R-0173

TW120 01/11

Safety Section 1-18

SAFETY

SAFETY

ITEM	PART NO.	QTY	LEVEL	DESCRIPTION
1.	D389	1	DECAL	Multi Hazard
2.	D390	1	DECAL	Pull Type Unit Hazards
3.	D388	1	DECAL	Driveline Hazards
4.	00756004	3	DANGER	D/L Shield Missing, Do Not Operate
5.	00756005	2**	DANGER	Rotating D/L Entanglement
6.	D137	1	INSTRUCT	CCW Blade Rotation
7.	D138	1	INSTRUCT	CW Blade Rotation
8.	D454	1	WARNING	Crushing Hazard (Decal under Deck)
9.	00771283	3	INSTRUCT	5 Year Gearbox Warranty
10.	99102	1	NAME	Rhino (2.8" x 10")
11.	00787406	2	NAME	Rhino Type
12.	00785891	2	NAME	TW 120 (Large)
13.	00785892	1	NAME	TW 120 (Small)
14.	D302	2	LOGO	Rhino (4-7/8 x 6-1/2)
15.	03200347	1	REFLECTOR	SMV Sign
16.	00760657	1	IMPORTANT	Rhino Genuine Parts
17.	nfs	1	SER PLT	Serial Number Plate
18.	D401	1	INSTRUCT	1000 RPM Overlay
19.	1458392	2	REFLECTOR	Red Reflectors
20.	1458393	2	REFLECTOR	Amber Reflectors
21.	00776031	1	-----	Canister, Operator's Manual
22.	00762120C	1	-----	Operator's Manual
23.	10058000	3	-----	Bolt
24.	00024100	6	-----	Flatwasher
25.	02959924	3	-----	Locknut
26.	D614	3	DANGER	Thrown Object Shield Missing
27.	D534	2	WARNING	Blade Bolt Torque
28.	D629	1	INSTRUCT	Lubrication Chart
29.	D518	1	WARNING	Jack Positioning
30.	D608	2	WARNING	Blade Timing

* Provided by Tractor Manufacturer

() Provided by Driveline Manufacturer

DECAL SHEETS

Dual Spindle Decal Sheet D442

TW120 Decal Sheet D483

SAFETY

Decal Description



SAFETY



⚠ DANGER	⚠ PELIGRO
KEEP AWAY THROWN OBJECTS HAZARD	CONSERVESE LEJOS OBJETOS LANZADOS
<p>Mower can throw objects up to 300 feet. TO AVOID SERIOUS INJURY OR DEATH to operator or bystanders:</p> <ul style="list-style-type: none"> • STOP mowing if bystanders or traffic come within 300 feet. • DO NOT OPERATE with thrown object shielding removed. • KEEP thrown object shielding in place and in good condition during operation. • INSPECT area for potential mower thrown object hazards before mowing. • Remove and AVOID objects such as wire, cable, metal objects and all other foreign material. • DO NOT ALLOW blades to contact solid objects like wire, rocks, posts, curbs or guard rails. • DO NOT OPERATE in transport position or with wings off ground. 	<p>Cortacésped puede lanzar objetos hasta 300 pies. PARA EVITAR LESION SERIA O MUERTE a operadores y personas presentes:</p> <ul style="list-style-type: none"> • Pare de segar si personas o trafico se acercan entre 300 pies del area de segar. • NO OPERE sin la cubierta para objetos lanzados. • MANTENGA la cubierta para objeto lanzado en su lugar y en buenas condiciones. • INSPECCIONE el área por si hay riesgos potenciales de objetos lanzados antes de segar. • REMUEVA y EVITE objetos come alambre, cable, objetos de metal y todo otro material extranjero. • NO DEJE que las cuchillas contacten los objetos sólidos como alambre, rocas, postes, borde de banquetta, o barandillas. • NO OPERE en posicion de transporte o con las alas levantadas. <p>D389_1</p>

⚠ DANGER	⚠ PELIGRO
KEEP AWAY Entanglement Hazard	MANTENGASE ALEJADO Riesgo de Enredamiento
<p>TO AVOID SERIOUS INJURY OR DEATH:</p> <ul style="list-style-type: none"> • DO NOT operate without guards in place and in good condition. • STAY AWAY and KEEP hands, feet and body AWAY from rotating blades, drivelines and parts that continue to move after power shut-off. WAIT until all moving elements have stopped. • STOP, LOOK and LISTEN for rotating motion before approaching implement. • STOP ENGINE and PTO, engage parking brake, lower implement, allow all moving parts to stop and remove key before dismounting from tractor. 	<p>PARA EVITAR LESION SERIA O MUERTE:</p> <ul style="list-style-type: none"> • NO opere sin la cubierta protectora en su lugar y en buen estado. • MANTENGASE ALEJADO y MANTENGA manos, pies y cuerpo LEJOS de las cuchillas girando, líneas de conducción, y partes que siguen moviendose después de que el poder es apagado. ESPERE hasta que todos los elementos móviles se han parado. • DETENGASE, OBSERVE y ESCUCHE por el movimiento de rotación antes de acercarse al implemento. • PARE EL MOTOR y el Toma De Fuerza (Barra Gitoria) active el freno de mano, baje el implemento, y permita que todas las partes móviles se paren y quite la llave antes de desmontar del tractor. <p>D389_2</p>

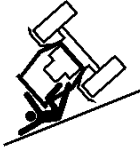
SAFETY

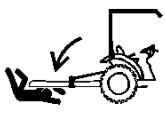
SAFETY

! DANGER	! PELIGRO
Crushing Hazard Injury or Death	Riesgo de Aplastamiento Lesion o Muerte
<p>TO AVOID SERIOUS INJURY OR DEATH:</p> <ul style="list-style-type: none"> USE tractor equipped with <u>R</u>ollover <u>P</u>rotective <u>S</u>tructure ("ROPS") including roll bar and seat belt. Keep roll bar in raised position. KEEP ALERT and AVOID hitting stumps, holes, ruts, and uneven terrain. ALWAYS BUCKLE UP seat belt. STAND CLEAR when removing transport latch, lowering or raising wings. CLEAR AREA of bystanders before lowering implement wings. IMPLEMENT CAN FALL from hydraulic failure or accidental operation of controls. BLOCK UP and securely support equipment before putting hands, feet or body under raised equipment or lifted components. <p style="text-align: right; font-size: small;">D389_3</p>	<div style="text-align: center;">     </div> <p style="padding-left: 5px;"> PARA EVITAR LESION SERIA O MUERTE: <ul style="list-style-type: none"> USE un tractor equipado con Estructura Protectora Contra Vuelcos ("ROPS") incluyendo barra antivuelco y cinturón de seguridad. Mantenga la barra antivuelco en la posición elevada. MANTENGASE ALERTO y EVITE golpes en troncos, agujeros, pozos o terreno en desnivel. SIEMPRE ABROCHE el cinturón de seguridad. PERMANEZCA ALEJADO al quitar el seguro de transporte, y al bajar o subir las alas. DESOCUPE el ÁREA de personas presentes antes de bajar las alas del implemento. EL IMPLEMENTO SE PUEDE CAER por el mal funcionamiento hidráulico o operación accidental de los controles. BLOQUEE y soporte con seguridad el equipo antes de poner manos, pies o cuerpo debajo del equipo o componentes levantados. </p>

! DANGER	! PELIGRO
Run Over Hazard Injury or Death	Riesgo de Atropello Lesión o Muerte
<p>TO AVOID SERIOUS INJURY OR DEATH:</p> <ul style="list-style-type: none"> ALWAYS USE <u>R</u>oll <u>O</u>ver <u>P</u>rotective <u>S</u>tructure ("ROPS") including ROLL BAR and SEAT BELT equipped tractors for mowing operations. ONLY START Tractor while seated in the operator's seat. DO NOT MOUNT or DISMOUNT Tractor in motion. NEVER ALLOW riders on tractor or implement. NEVER ALLOW children to operate or ride on tractor or implement. KEEP BYSTANDERS CLEAR of area before moving tractor or implement. STOP ENGINE AND PTO, engage parking brake, lower implement, allow all moving parts to stop and remove key before dismounting from tractor. <p style="text-align: right; font-size: small;">D389_4</p>	<div style="text-align: center;">    </div> <p style="padding-left: 5px;"> PARA EVITAR LESION SERIA O MUERTE: <ul style="list-style-type: none"> SIEMPRE USE tractors equipados con una Estructura Protectora Contra Vuelcos ("ROPS") incluyendo BARRA ANTIVUELCO y CINTURON DE SEGURIDAD al segar. SOLO ENCIENDA el tractor mientras que esta sentado en el asiento del operador. NO MONTE o DESMONTE el tractor en movimiento. NUNCA PERMITA pasajeros en el tractor o implemento. NUNCA PERMITA que niños operen o se monten en el tractor o implemento. MANTENGA LAS PERSONAS PRESENTES LEJOS de la area antes de mover el tractor o implemento. PARE EL MOTOR Y Toma De Fuerza (Barro Gitatoria), aplique el freno de mano, baje el implemento, y deje que todas las partes moviles paren completamente, y quite la llave antes de desmontar el tractor. </p>

SAFETY

SAFETY

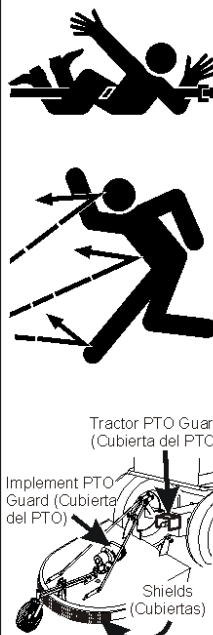
! DANGER	! PELIGRO
<p>TO AVOID SERIOUS INJURY OR DEATH FROM ENTANGLEMENT AND THROWN OBJECTS:</p> <ul style="list-style-type: none"> • DO NOT OPERATE mower without shields and guards in place and in good condition. • DO NOT OPERATE with thrown object shielding or guards missing. • Thrown objects shielding, PTO and gearbox guarding are SUBJECT TO WEAR. • REPAIR OR REPLACE shielding if damaged, broken or missing. See Operator's Manual for all Shields and Guards. • ALWAYS REPLACE GUARDS that have been removed for service or maintenance. • DO NOT STEP ON drivelines or guards. <small>D389_5</small> 	<div style="text-align: center;">  </div> <p>PARA EVITAR LESION SERIA O MUERTE POR ENREDAMIENTO Y OBJETOS LANZADOS:</p> <ul style="list-style-type: none"> • NO OPERE la unidad sin cubiertas maya protectoras en su lugar y en buenas condiciones. • NO OPERE sin las cubiertas de objetos lanzados o si faltan las maya protectoras. • Cubierta de Objetos Lanzados, Toma De Fuerza (Barra Gitorial) y guardias de caja de engranaje son SUJETO AL DESGASTE. • REPARE O REEMPLACE cubiertas si son dañadas, quebradas, o si faltan. • SIEMPRE REEMPLACE CUBIERTAS que han sido quitadas para servicio o mantenimiento. • NO PISE EN las líneas de conducción o cubiertas.

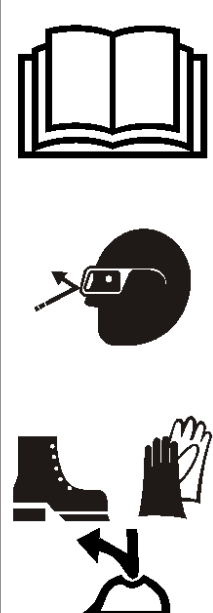
! DANGER	! PELIGRO
<p>TO AVOID SERIOUS INJURY OR DEATH:</p> <ul style="list-style-type: none"> • READ AND UNDERSTAND the provided Operator's Manuals, safety signs and information decals for tractor and implement before operating equipment. • CONTACT DEALER immediately if you do not have manuals. • CONTACT DEALER to explain any instructions not fully understood. • KNOW HOW to stop tractor and equipment quickly for an emergency. • ALWAYS WEAR safety glasses. • WEAR hard hat, safety shoes and gloves for protection when operating equipment. 	<div style="text-align: center;">  </div> <p>PARA EVITAR LESION SERIA O MUERTE:</p> <ul style="list-style-type: none"> • LEA Y ENTIENDA el Manual de Operador proporcionado, signos de seguridad y calcomanias informativas para el tractor y implemento antes de operar el equipo. • CONTACTE AL DISTRIBUIDOR inmediatamente si no tiene los manuales. • CONTACTE AL DISTRIBUIDOR para que le explique cualquier instrucciones que no entiende completamente. • ENTIENDA COMO parar el tractor y equipo rapidamente en caso de una emergencia. • SIEMPRE USE lentes de seguridad. • USE un casco, zapatos de seguridad y guantes para su protection cuando esta operando el equipo. <small>D389_6</small>

SAFETY

SAFETY

⚠ WARNING

TO AVOID SERIOUS INJURY OR DEATH FROM HIGH PRESSURE HYDRAULIC OIL LEAKS PENETRATING SKIN:

- DO NOT OPERATE equipment with oil or fuel leaks.
- KEEP all hydraulic hoses, lines and connections in good condition and tight before applying system pressure.
- Relieve hydraulic pressure before disconnecting lines or working on the system.
- REMOVE and replace hose if you suspect it leaks. Have dealer test it for leaks.

HIGH PRESSURE FLUID LEAKS CAN BE INVISIBLE. WHEN CHECKING FOR HYDRAULIC LEAKS AND WORKING AROUND HYDRAULIC SYSTEMS:

- DO NOT use hands to check for leaks.
- ALWAYS WEAR safety glasses and impenetrable gloves.
- USE paper or cardboard to search for leaks.
- KEEP hands and body AWAY from pin holes and nozzles ejecting hydraulic fluid.
- Hydraulic fluid may cause gangrene if not surgically removed immediately by a doctor familiar with this form of injury.

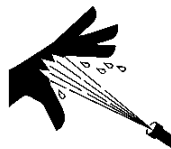

⚠ ADVERTENCIA

PARA EVITAR LESION SERIA O MUERTE POR LA PENETRACION A LA PIEL POR ALTA PRESION DE ACEITE HIDRAULICO:

- NO OPERE el equipo con fugas de aceite o combustible.
- MANTENGA todas las mangueras hidráulicas, líneas y conexiones en buenas condiciones y apretadas antes de aplicar presión al sistema.
- Releve la presión hidráulica antes de desconectar las líneas o trabajar en le sistema.
- QUITE y reemplace la manguera si sospecha que hay fuga.

FUGAS DE ALTA PRESIÓN PUEDEN SER INVISIBLE. AL VERIFICAR POR FUGAS HIDRAULICAS Y TRABAJANDO ALREDEDOR DE SISTEMAS HIDRAULICOS:

- NO use las manos para verificar si hay agujeros.
- SIEMPRE USE lentes de seguridad y guantes impenetrables.
- USE papel o un cartón para buscar agujeros.
- NO USE las manos o partes del cuerpo para buscar agujeros.
- MANTENGA manos y cuerpo LEJOS de agujeros de afiler y boquillas que expulsan el líquido hidráulicos. D390_1

⚠ WARNING

TO AVOID SERIOUS INJURY AND DEATH WHEN TOWING EQUIPMENT:

- DO NOT TOW with trucks or other vehicles.
- ONLY transport with properly sized and equipped tractor. (see Operator's Manual)
- ATTACH implement SAFETY CHAIN to tractor.
- CHECK SMV sign, reflectors and warning lights for visibility behind unit.
- TURN ON tractor flashing warning lights.

TO AVOID LOSS OF TOWING CONTROL:

- DO NOT tow at speeds over 20 mph.
- REDUCE SPEED on inclines, in turns and in poor towing conditions.

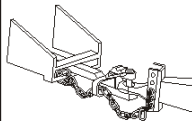

⚠ ADVERTENCIA

PARA EVITAR LESION SERIA O MUERTE AL REMOLCAR EL EQUIPO:

- NO REMOLQUE con camion o cualquier otro vehículo.
- SOLO transporte con un tractor bien equipado y de tamaño adecuado (vea el Manual de Operador)
- APIQUE LA CEDENA DE SEGURIDAD al tractor.
- VERIFIQUE EL SMV, reflectors, y luces intermitentes de advertencia pueden ser vistos claramente por detras de la unidad.
- PRIENDA las luces intermitentes de advertencia.

PARA EVITAR PERDIDA DE CONTROL DE REMOLQUE:

- NO remolque en velocidades arriba de 20 mph.
- REDUZCA LA VELOCIDAD en inclinas, en vueltas y en la pobres condiciones de remolque. D390_2

SAFETY

SAFETY

⚠ WARNING	⚠ ADVERTENCIA
<p>TO AVOID EQUIPMENT AND GRASS FIRES:</p> <ul style="list-style-type: none"> • CLEAR AWAY grass or debris from slip clutches, gearboxes, drivelines and decks. <p>TO AVOID FIRE IGNITION:</p> <ul style="list-style-type: none"> • DO NOT ALLOW BLADES TO CONTACT rocks, metal or solid objects. 	 <p>PARA EVITAR INCENDIOS DE EQUIPO Y CÉSPED:</p> <ul style="list-style-type: none"> • QUITE el césped o escombros de embrague deslizante, caja de engranajes, líneas de conducción y cubiertas. <p>PARA EVITAR INCENDIOS POR IGNICIÓN:</p> <ul style="list-style-type: none"> • NO PERMITA QUE LAS LAMINAS CONTACTEN piedras, metal o objetos solidos. <p style="text-align: right;">D390_3</p>

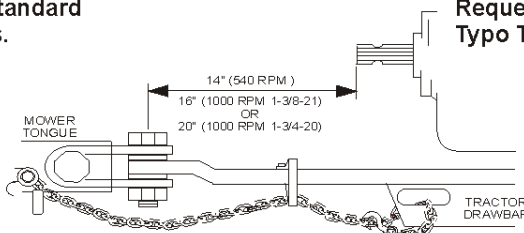

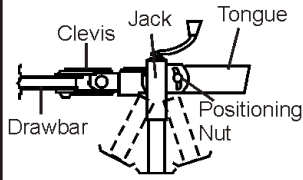

IMPORTANT	IMPORTANTE
<p>Required for Standard Pull Type Units.</p>	<p>Requerido por Unidades de Tipo Tirón Estandar.</p>
	
<p>Attach Safety Chain securely. Coloque la Cadena de Seguridad seguramente.</p>	
D390_4	

⚠ DANGER	⚠ PELIGRO
 <p style="text-align: right; font-size: small;">00756004</p>	
<p>GUARD MISSING DO NOT OPERATE</p>	<p>FALTA LA CUBIERTA NO OPERE</p>
⚠ DANGER	⚠ PELIGRO

⚠ WARNING	
	
Rated Loads	Vertical: 1800 lbs Side: 550 lbs
TO AVOID SERIOUS INJURY:	
<ul style="list-style-type: none"> • Fully engage jack retaining pin. • Adjust jack vertically. • Torque positioning nut to 250 ft-lbs. • DO NOT exceed rated loads. 	
⚠ ADVERTENCIA	
PARA EVITAR LESION SERIA:	
<ul style="list-style-type: none"> • Aplique completamente el perno de retencion al gato. • Ajuste el gato verticalmente. • Apriete la tuerca a torsion de 250 p/lbs. • NO exceda las cargas calculadas. 	
D518	

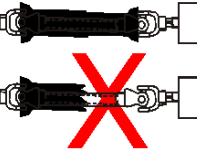
SAFETY

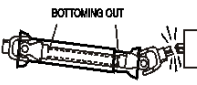
SAFETY

⚠ DANGER	⚠ PELIGRO
<p>TO AVOID SERIOUS INJURY OR DEATH FROM DRIVELINE CONTACT, DRIVELINE SEPARATION OR PTO STUB SHAFT FAILURE:</p> <ul style="list-style-type: none"> STOP, LOOK and LISTEN for rotating motion before approaching implement. STAY AWAY and KEEP hands, feet and body AWAY from rotating parts until all moving elements have stopped. ALWAYS shut off PTO before dismounting. DO NOT operate if PTO shields are damaged or missing. LOCK DRIVELINE locking collar YOKE to tractor PTO Shaft. PUSH AND PULL on yoke until collar clicks and locks yoke in place. USE CORRECT length drivelines for implement. (See Operator's Manuals for procedure) CHECK driveline guards for free rotation and sufficient overlap to avoid unshielded areas. DO NOT USE PTO ADAPTER <p style="font-size: small;">D388_1</p>	<div style="text-align: center;">  </div> <div style="text-align: center;">  </div> <div style="text-align: center;"> <p style="font-size: small;">PTO (Barra Giteratoria)</p>  </div> <div style="text-align: center;"> <p style="font-size: small;">BOTTOMING OUT</p>  </div> <div style="text-align: center;">  </div> <p style="font-size: small;">PARA EVITAR LESION SERIA O MUERTE POR CONTACTO A LA LÍNEA DE CONDUCCIÓN, SEPARACION DE LÍNEA DE CONDUCCIÓN O EL FRACASO DEL EJE DE PTO:</p> <ul style="list-style-type: none"> PARE, MIRE y ESCUCHE por el movimiento de rotación antes de acercarse al implemento. MANTENGASE ALEJADO y MANTENGA manos, pies y cuerpo LEJOS de partes girando, hasta que todos los elementos de movimiento se han parado. SIEMPRE apage la Toma De Fuerza (Barra Giteratoria) antes de desmontar. NO opere si las cubiertas de Toma De Fuerza (Barra Giteratoria) estan dañadas. TRABE el YUGO de collar de fijación del la LÍNEA DE CONDUCCIÓN al eje de PTO (Barra Giteratoria) del tractor. EMPUJE Y JALE el yugo hasta que el collar de fijación hace clic y el yugo se trava en lugar. USE la longitud de línea de conducción CORRECTA para el implemento. (Vea el Manual de Operador para el Procedimiento) REVISE las guardias de línea de conducción por giracion libre y suficiente traslape para evitar areas sin cobertura. NO UTILICE UN ADAPTOR PARA LA TOMA DE FUERZA (Barra Giteratoria).



⚠ WARNING	⚠ ADVERTENCIA
<p>OPERATE THIS MACHINE AT 540 RPM</p> <p>TRACTOR PTO SPEED ONLY. Overspeeding PTO may cause component failure resulting in bodily injury. TRACTOR PTO ROTATION: CLOCKWISE</p> <p style="font-size: small;">D388_2</p>	<div style="text-align: center;">  </div> <p>OPERE ESTA MÁQUINA A 540 RPM</p> <p>SOLAMENTE OPERE ESTA MÁQUINA A LA VELOCIDAD DE PTO (TOMA DE FUERZA O BARRA GITATORIA) DEL TRACTOR DE 540 RPM. El sobre exceso de velocidad de PTO puede causar el fracaso de componente que resultara en lesión. ROTACION DE PTO DEL TRACTOR: EN SENTIDO HORARIO</p> <p style="font-size: small; text-align: right;">D388</p>

⚠ WARNING	⚠ ADVERTENCIA
<p>OPERATE THIS MACHINE AT 1000 RPM</p> <p>TRACTOR PTO SPEED ONLY. Overspeeding PTO may cause component failure resulting in bodily injury. TRACTOR PTO ROTATION: CLOCKWISE</p> <p style="font-size: small;">D401</p>	<div style="text-align: center;">  </div> <p>OPERE ESTA MÁQUINA A 1000 RPM</p> <p>SOLAMENTE OPERE ESTA MÁQUINA A LA VELOCIDAD DE PTO (TOMA DE FUERZA O BARRA GITATORIA) DEL TRACTOR DE 1000 RPM. El sobre exceso de velocidad de PTO puede causar el fracaso de componente que resultara en lesión. ROTACION DE PTO DEL TRACTOR: EN SENTIDO HORARIO</p>

SAFETY

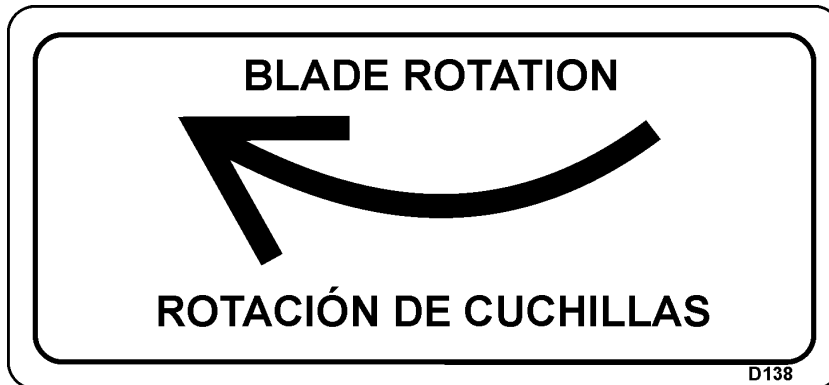
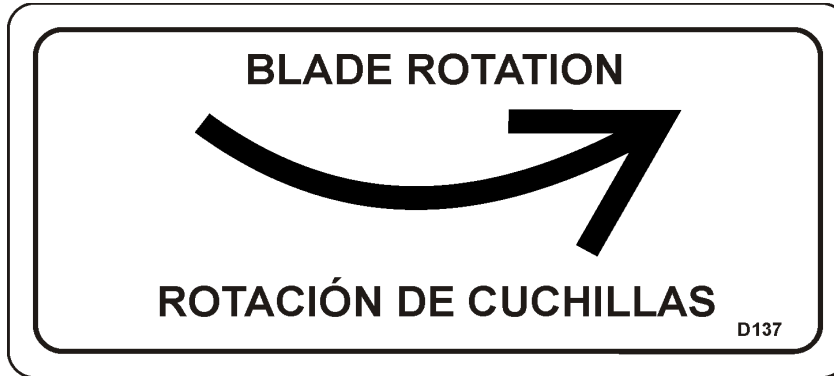
SAFETY



 WARNING	 ADVERTENCIA
<p>TO AVOID SERIOUS INJURY OR DEATH FROM BLADE ATTACHMENT FAILURE:</p> <ul style="list-style-type: none">• Torque blade bolt to 600 ft lbs.• ALWAYS replace blades in pairs.• ALWAYS replace blades with new bolts and nuts.	<p>PARA EVITAR LESION SERIA O MUERTE POR EL FALLO DEL ACOPLAMIENTO DE LAS CUCHILLAS:</p> <ul style="list-style-type: none">• Apriete los tornillos a torsión de 600 libras pie.• Siempre reemplace las cuchillas en pares.• SIEMPRE reemplace las cuchillas con tornillos y tuercas nuevas.

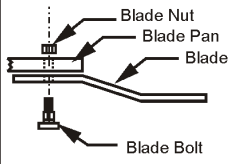

D534

SAFETY

SAFETY

⚠ WARNING	⚠ ADVERTENCIA
<p>Non-genuine parts can fail catastrophically. TO AVOID SERIOUS INJURY OR DEATH:</p> <ul style="list-style-type: none"> ONLY use genuine RHINO replacement parts. Non-genuine parts can fail creating hazardous conditions for operator and bystanders. <p>Contact local dealer or RHINO about repair parts at:</p> <p>1020 S. Sangamon Ave., Gibson City, IL 60936 Customer Service: 800-446-5158. Email: parts@servis-rhino.com</p> <p style="text-align: right; font-size: small;">00760657_A</p>	<p>Partes que no son auténticas pueden fallar catastróficamente. PARA EVITAR LESION SERIA O MUERTE:</p> <ul style="list-style-type: none"> Use SOLAMENTE las partes de reemplazo auténticas de RHINO. Partes que no son auténticas pueden fallar y causar condiciones peligrosas para el operador y personas presentes. <p>Contacte a su distribuidor local o RHINO sobre partes de reparo a:</p> <p>1020 S. Sangamon Ave., Gibson City, IL 60936 Servicio al Cliente: 800-446-5158. Correo Electronico: parts@servis-rhino.com</p>
IMPORTANT	IMPORTANTE
<p style="text-align: center;">BE AWARE BE TRAINED BE ALERT Before Operating BE ALIVE this Mower</p> <p>To prevent serious injury to yourself and/or bystanders, be trained in Safe Mowing Practices.</p> <p>Alamo Group Companies, Alamo Industrial, Bush Hog, M&W, Rhino, Schulte and Tiger as well as AEM and FEMA provide training material that is critical for your Safety and the Safety of others when operating this equipment. Make these Safety Procedures an important part of every workday.</p> <p>Read and understand the Operator's Manual.</p> <p>Do not let untrained individuals operate this equipment.</p> <p>Contact your Dealer, AEM (www.aem.org), FEMA (314-878-2304, www.FarmEquipment.org), or Alamo Group (www.Alamo-Group.com) for information on training material or courses that provide training in Safer Operating Practices for Mowers.</p>	<p style="text-align: center;">ESTE CONSCIENTE SEA ENTRENADO ESTE ALERTO Antes de Funcionar ESTE VIVO Cortacésped</p> <p>Para prevenir lesiones graves a usted y/o personas presentes, sea entrenado en la Practica de Segar Seguro.</p> <p>Companias de Alamo Group, Alamo Industrial, Bush Hog, M&W, Rhino, Schulte y Tiger asi como AEM y FEMA proporcionan material para entrenar que es esencial para su seguridad y la seguridad de otros al operar este equipo. Haga estos procedimientos de seguridad una parte importante de su dia de trabajo.</p> <p>Lea y entienda el Manual de Operadores.</p> <p>No permita que personas sin entrenamiento funcionen este equipo.</p> <p>Contacte a su distribuidor, AEM (www.aem.org), FEMA (314-878-2304, www.FarmEquipment.org), o Alamo Group (www.Alamo-Group.com) para la informacion sobre el material de entrenamiento o cursos que ofrecen el entenamiento de Prácticas de Operación para Cortadoras.</p> <p style="text-align: right; font-size: small;">00760657_B 00760657</p>

SAFETY

SAFETY

⚠ WARNING		⚠ ADVERTENCIA	
Crushing Hazard	<p>Shipping Bracket</p>	Riesgo de Aplastamiento	<p>Para evitar lesión por la caída de la cortadora:</p> <ul style="list-style-type: none"> • NO almacene la cortadora verticalmente en los soportes de transporte. • Almacene en posición acostada.
<p>To avoid injury from mower falling over:</p> <ul style="list-style-type: none"> • DO NOT store mower vertically on shipping brackets. • Store mower lying down. 		D454	

⚠ WARNING		⚠ ADVERTENCIA	
THROWN OBJECT HAZARD		RIESGO OBJETOS LANZADOS	<p>Las cuchillas que se golpean una al otra puede resultar en partes rotas y partes lanzadas.</p> <p>Para evitar herida y partes rotas:</p> <ul style="list-style-type: none"> • Calcule perpendicular las cuchillas una al otra.
<p>Blades striking each other can result in broken parts and thrown objects.</p> <p>To avoid injury and broken parts:</p> <ul style="list-style-type: none"> • Time blades perpendicular to each other. 		D608	

⚠ DANGER		⚠ PELIGRO	
THROWN OBJECT HAZARD		RIESGO DE OBJETOS LANZADOS	<p>PARA EVITAR LESION SERIA O MUERTE: NO OPERE si la Cubierta de Objetos Lanzados esta dañada o falta.</p> <p>MANTENGA la Cubierta de Objetos Lanzados</p>
<p>TO AVOID SERIOUS INJURY OR DEATH: DO NOT OPERATE if Thrown Object Shielding is damaged or missing.</p> <p>MAINTAIN Thrown Object Shielding</p> <p>↙ HERE ↓</p>		<p>↓ AQUÍ ↘</p>	

SAFETY

Federal Laws and Regulations

This section is intended to explain in broad terms the concept and effect of federal laws and regulations concerning employer and employee equipment operators. This section is not intended as a legal interpretation of the law and should not be considered as such.

Employer-Employee Operator Regulations

U.S. Public Law 91-596 (The Williams-Steiger Occupational and Health Act of 1970) OSHA

This Act Seeks:

“...to assure so far as possible every working man and woman in the nation safe and healthful working conditions and to preserve our human resources...”

DUTIES

Sec. 5 (a) Each employer-

- (1) shall furnish to each of his employees employment and a place of employment which are free from recognized hazards that are causing or are likely to cause death or serious physical harm to his employees;
- (2) shall comply with occupational safety and health standards promulgated under this Act.
- (b) Each employee shall comply with occupational safety and health standards and all rules, regulations and orders issued pursuant to this Act which are applicable to his own actions and conduct.

OSHA Training Requirements

Title 29, Code of Federal Regulations Part 1928.57(a)(6). www.osha.gov

Operator instructions. At the time of initial assignment and at least annually thereafter, the employer shall instruct every employee who operates an agricultural tractor and implements in the safe operating practices and servicing of equipment with which they are or will be involved, and of any other practices dictated by the work environment.

Keep all guards in place when the machine is in operation;

Permit no riders on equipment

Stop engine, disconnect the power source, and wait for all machine movement to stop before servicing, adjusting, cleaning or unclogging the equipment, except where the machine must be running to be properly serviced or maintained, in which case the employer shall instruct employees as to all steps and procedures which are necessary to safely service or maintain the equipment.

Make sure everyone is clear of machinery before starting the engine, engaging power, or operating the machine.

Employer Responsibilities:

To ensure employee safety during Tractor and Implement operation, it is the employer's responsibility to:

1. Train the employee in the proper and safe operation of the Tractor and Implement.
2. Require that the employee read and fully understand the Tractor and Implement Operator's manual.
3. Permit only qualified and properly trained employees to operate the Tractor and Implement.
4. Maintain the Tractor and Implement in a safe operational condition and maintain all shields and guards on the equipment.
5. Ensure the Tractor is equipped with a functional ROPS and seat belt and require that the employee operator securely fasten the safety belt and operate with the ROPS in the raised position at all times.
6. Forbid the employee operator to carry additional riders on the Tractor or Implement.
7. Provide the required tools to maintain the Tractor and Implement in a good safe working condition and provide the necessary support devices to secure the equipment safely while performing repairs and service.
8. Require that the employee operator stop operation if bystanders or passersby come within 300 feet.

Child Labor Under 16 Years of Age

Some regulations specify that no one under the age of 16 may operate power machinery. It is your responsibility to know what these regulations are in your own area or situation. (Refer to U.S. Dept. of Labor, Employment Standard Administration, Wage & Home Division, Child Labor Bulletin #102.)

INDUSTRIAL/
AGRICULTURAL MOWER



www.aem.org

SAFETY MANUAL

FOR OPERATING AND MAINTENANCE PERSONNEL

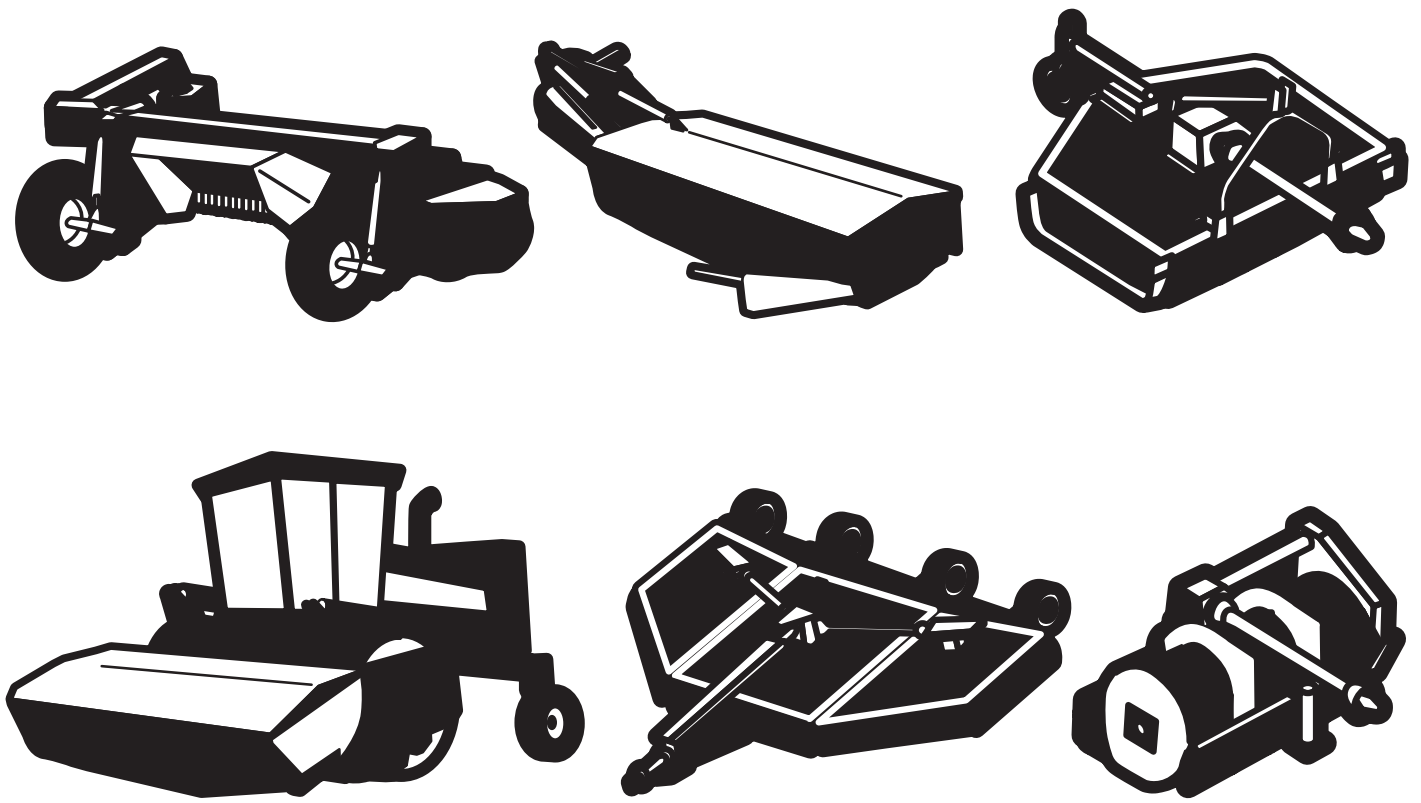

Contents

Acknowledgment	2
Foreword	2
Safety Alerts	3
A Word To The User/Operator	3
The Industrial/Agricultural Mower	4
Follow A Safety Program	5
Prepare For Safe Operation	9
Start Safely	13
Operate Safely	13
Park Safely	18
Shut Down Safely	18
Perform Maintenance Safely	19
Final Word To The User	26

Acknowledgment

We wish to acknowledge the contributions of the members of AEM's Industrial/Agricultural Mower Manufacturers Council to the preparation of this Safety Manual.

NOTICE OF COPYRIGHT PROTECTION

Copyright, 2010, by the Association of Equipment Manufacturers. All rights reserved. This work may not be reproduced or disseminated in whole or in part by any means without the prior written permission of the Association of Equipment Manufacturers.

Copyright 2010© AEM (Association of Equipment Manufacturers)
Revised 01/03, 09/10

Foreword

This safety manual is intended to point out some of the basic safety situations that may be encountered during the normal operation and maintenance of your machine and to instruct you in safety practices for dealing with these conditions. This manual is **NOT** a substitute for the mower manufacturer's operator's manual(s).

Additional precautions may be necessary, or some instructions may not apply, depending on equipment, attachments and conditions at the worksite or in the service area. The manufacturer has no direct control over equipment application, operation, inspection or maintenance. Therefore, it is **YOUR** responsibility to use good safety practices in these areas.

The information provided in this manual supplements the specific information about your machine that is contained in the manufacturer's operator's manual(s). Other information that may affect the safe operation of your machine may be contained on safety signs or in insurance requirements, employer's safety and training programs, safety codes, local, state/provincial and federal laws, rules and regulations.

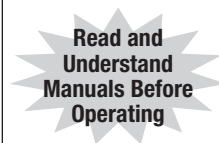
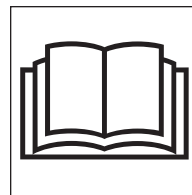

IMPORTANT! Before you operate the mower, make sure you have the manufacturer's operator's manual(s) for this machine and all attachments. If the manufacturer's manuals are missing, obtain replacement manuals from your employer, equipment dealer or directly from the manufacturer. Keep this safety manual and the manufacturer's manuals with the machine at all times. Read and understand all manuals.

The AEM Mower Safety Practices video is available to train and reinforce good safety practices. Operators are encouraged to periodically view the safety video.

Safety Alerts

Symbol

This Safety Alert Symbol means: **“ATTENTION! STAY ALERT! YOUR SAFETY IS INVOLVED!”**

The Safety Alert Symbol identifies important safety messages on equipment, safety signs, in manuals or elsewhere. When you see this symbol, be alert to the possibility of death or personal injury. Follow instructions in the safety message.







Reasons Safety is Important:

- Accidents disable and kill.
- Accidents cost.
- Accidents can be avoided.

Signal Words

Signal words are distinctive words that will typically be found on safety signs on the mower and other worksite equipment. These words may also be found in this manual and the manufacturer's manuals. These words are intended to alert the operator to a hazard and the degree of severity of the hazard.

-  **DANGER** indicates a hazardous situation which, if not avoided, will result in death or serious injury.
-  **WARNING** indicates a hazardous situation which, if not avoided, could result in death or serious injury.
-  **CAUTION** indicates a hazardous situation which, if not avoided, could result in minor or moderate injury.
-  **NOTICE** indicates a property damage message.

A Word To The User/Operator

It is **YOUR** responsibility to read and understand the safety manual and the manufacturer's manuals before operating this machine. This safety manual takes you step by step through your working day.

Hazard Recognition and Accident Prevention depend upon you being alert, careful and properly trained in the operation, transport, maintenance and storage of this equipment.

Graphics have been provided to help you understand the text.

Remember that **YOU** are the key to safety. Good safety practices not only protect you but also protect the people around you. Study and understand this manual and the manufacturer's manuals for your specific machine. Make them a working part of your safety program. Keep in mind that this safety manual is written for industrial/agricultural mowers.

Contact the manufacturer of your equipment to answer any questions about safe operation that remain after studying the manufacturer's operator's manual(s) and this safety manual.



Practice all other usual and customary safe working precautions and above all:

REMEMBER — SAFETY IS UP TO YOU!

YOU CAN PREVENT SERIOUS INJURY OR DEATH CAUSED BY UNSAFE WORK PRACTICES!

The Industrial/Agricultural Mower

Industrial/Agricultural Mower Types

Mowers are used for pasture clipping, crop residue shredding, heavy brush cutting, waterways, right-of-ways, roadside or highway mowing. Also, these mowers are used for cutting grass and other growth in public areas such as parks and cemeteries.

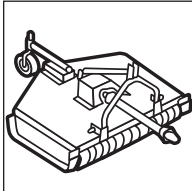

Rotary

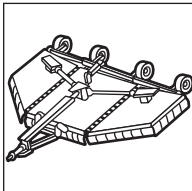

Folding Wing Rotary

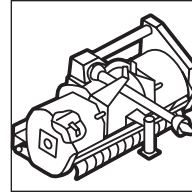

Flail

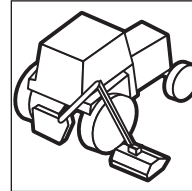

Boom

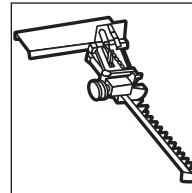

Sickle Bar

The Industrial/Agricultural Mower

Agricultural Disc Mower Types

Disc mowers are designed and equipped to cut hay crops at higher field speed.

Disc mower/conditioners mow and condition crops.

Self-propelled windrowers mow and form conditioned hay into windrows.

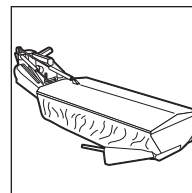

Disc Mower

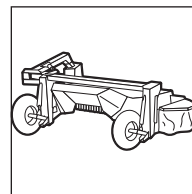

Disc Mower Conditioner

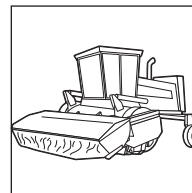

Self-propelled Windrower

Follow A Safety Program

Protect Yourself

Wear personal protective clothing and Personal Protective Equipment (PPE) issued to you or called for by job conditions. You must **ALWAYS** wear safety glasses with side shields.

You may also need:

- Hard hat
- Safety shoes
- Safety goggles or face shield
- Heavy gloves
- Hearing protection
- Reflective clothing
- Wet weather gear
- Respirator or filter mask

Wear whatever is needed—don't take chances.

WARNING! Prevent death or serious injury from entanglement. **Do not wear loose clothing or accessories. Tie up long hair. Stay away from all rotating components when the engine is running.** Contact, wrapping or entanglement with rotating or moving parts could result in death or serious injury.

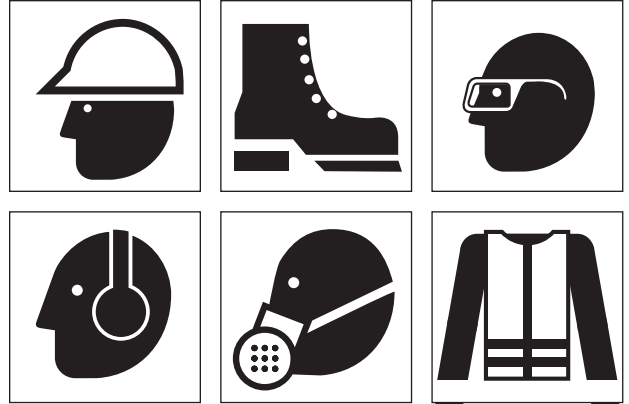

Avoid Entanglement

Follow A Safety Program

- Read, understand and follow the manufacturer's written instructions found in the operator's manual(s) and safety signs on mower and tractor.
- Have operational training with mower and tractor.
- Take advantage of training programs offered in your area.
- Ask your equipment dealer or supervisor to explain things you do not understand.
- Explain the written instructions in the operator's manual(s) and safety signs to those users or operators who cannot read.
- Inspect the mower and tractor daily before operating. Ensure all guards are in place and the equipment is operating properly.
- Never smoke while operating. Never fill the fuel tank with the engine running or near an open flame.
- Make sure you have adequate visibility and sufficient lighting.
- Know the pinch points and rotating parts. Awareness on your part can prevent accidents.
- Never attempt to operate the controls except from the operator's seat. Improperly controlled functions could produce unexpected machine movement and result in serious injury or death.

- Shut down the mower and tractor before dismounting. (See page 18, **Proper Equipment Shut Down Practices.**)

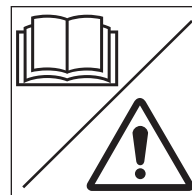

Read, Understand and Follow Manuals and Safety Signs



Avoid Rotating Parts

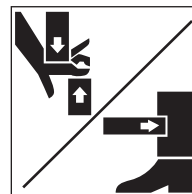

Know and Avoid Pinch Points

Follow A Safety Program

Avoid Injury From Raised Equipment

Avoid possible crushing injury from falling mower or other raised equipment.



**Avoid Crushing –
Block Up or
Securely Support
Mower**

Before working near or under raised mower or equipment parts:

- Securely support or block up raised mower or equipment parts according to the operator's manual.
- Securely support, block up or lock up wings with approved locking devices or lower mower or equipment parts to the ground.
- Use transport locks when transporting mower on public roads.

Avoid Injury From High Pressure Fluid

Avoid fluid injection injury due to high pressure fluid leaks.



**High Pressure
Fluid Can Inject
into the Body**

If any fluid is injected into the skin, it must be removed within a few hours by a doctor familiar with this type of injury.

Fluid leaks under pressure may not be visible. When checking for leaks or working around pressurized systems:

- Read manufacturer's operator's manual(s) for recommended safety practices.
- Wear a face shield or safety goggles for eye protection.
- Use a piece of cardboard or wood to check for leaks; **DO NOT use your hands.**
- Relieve system pressure before disconnecting lines.
- Check for and repair damaged or leaking lines, pipes and hoses.
- Check for and tighten loose connections.
- Purge air from system before operating.

Follow A Safety Program

Avoid Injury From Fire And Explosion

Set the parking brake, shut the mower and tractor engine down and remove the key while filling the fuel tank. Use extra caution when fueling a hot engine. Never smoke while fueling. Avoid sparks by grounding the fuel nozzle against the filler neck.

The fumes in an empty fuel tank are explosive. Never weld or cut on fuel lines, tanks or containers.

Remove all trash or mowing debris from the machine daily or as needed. Keep debris away from engine, exhaust, slip clutches and other heat sources. Use spark arrestors, as appropriate, on the engine exhaust system. Make sure oily rags or other flammable material are not stored on the machine.

Check for fuel, oil or hydraulic fluid leaks. Repair the leaks and clean the machine before you operate it.

Ether/cold start fluid is flammable. Do not smoke when using ether/cold start fluid. Always follow the instructions on the can and in the manufacturer's operator's manual(s) for your mower. Do not use ether/cold start fluid if the engine is equipped with a glow plug or other type of preheater.

Always use a nonflammable solvent when you clean parts. Do not use gasoline, diesel fuel or other flammable fluids.

Store all flammable fluids and materials away from your machine and work area.

Know where fire extinguishers are kept—how they operate—and what type of fire they are for. Check readiness of fire extinguishers according to manufacturer's instructions. Make sure each tractor is equipped with a fire extinguisher.



**No Smoking
and No Open
Flames**

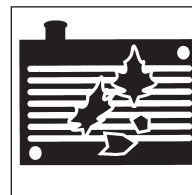

**Remove
Debris Daily or
As Needed**

Follow A Safety Program

Be Alert!

Know where to get assistance. Know how to use a first aid kit and fire extinguisher/fire suppression system.

Be Aware!

Take advantage of training programs offered.

Be Careful!

Human error is caused by many factors: carelessness, fatigue, overload, preoccupation, unfamiliarity of operator with the machine, drugs, and alcohol to name a few. Damage to the tractor or mower can be fixed in a short period of time, but injury, or death, has a lasting effect.

For your safety and the safety of others, encourage your fellow workers to act safely.



For Safe Operation

You must be a qualified and authorized operator for proper operation of your machine. You must clearly understand the written instructions supplied by the manufacturer, be trained—including actual operation of the mower—and know the safety rules and regulations for the worksite. It is a good safety practice to point out and explain safety signs and practices and ensure others understand the importance of following these instructions.

WARNING! Drugs and alcohol affect an operator's alertness and coordination and the operator's ability to safely operate the equipment. **Never use drugs or alcohol while operating the mowing equipment. Never knowingly allow anyone to operate this machine when their alertness or coordination is impaired.** An operator taking prescription or over-the-counter medication must consult a medical professional regarding any side effects of the medication that would hinder their ability to safely operate this equipment.

Follow A Safety Program

Know The Rules

Most employers have rules governing operation and maintenance of equipment. Before you start work at a new location, check with your supervisor or the safety coordinator. Ask about the rules you will be expected to obey.

The Occupational Safety and Health Administration (OSHA) enforces federal laws within the United States that apply to safe operation, application and maintenance of equipment on a worksite. It is the employer's responsibility to comply with these laws. An OSHA representative may periodically inspect a worksite to see that these laws are being followed.

There may also be local or state/provincial laws or international regulations that apply to this equipment and its use, along with specific worksite or employer rules. It is important that you know and comply with all applicable laws and rules, including those requiring operator training and certification.

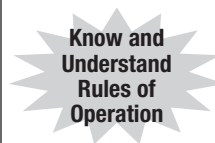

These are some of the rules you must work by:

- A ROPS and seat belt-equipped tractor is a federal government (OSHA) requirement for operator protection during mowing operations. An enclosed cab provides additional operator protection from thrown objects. Check your mower operator's manual to see if a tractor cab is also required.
- Wear and check that others are wearing proper clothing and personal protective equipment.
- Inspect your machine and attachments before each use as specified by the manufacturer and your employer.
- Know the limitations and operating characteristics of your mowing equipment. Do not misuse it.
- Have all provided shields and guards properly installed before operating the machine.
- Never modify or remove any part of the machine (except for service—then make sure it is replaced).

Follow A Safety Program

Some Rules You Must Work By (continued)

- Only qualified and authorized individuals may operate this equipment.
- **Never allow children to play on, ride on or operate** the equipment. Children **are not** qualified to operate this equipment.
- **Do not allow any riders.**
- Use three-point contact (handholds and steps) and face the equipment when mounting or dismounting.
- Keep bystanders 300 ft (92 m) from the mowing operation.
- Know the worksite before you use the mower. Be aware of possible terrain hazards that you may encounter. Remove or mark obstacles and debris that could damage or be thrown by the mower.
- Only use attachments and parts that are approved by the mower manufacturer.
- Make sure all attachments are lowered, set the parking brake, shut off the engine and cycle the control levers. Remove the key before leaving the tractor. (See page 18, **Proper Equipment Shut Down Practices.**)
- When transporting the mower on a trailer, follow the manufacturer's detailed instructions for loading, tying down and unloading the mower.



Keep Children Away from Equipment

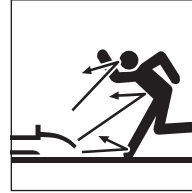

Keep Bystanders Away



No Riders

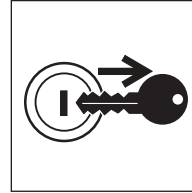

Shut Down Unattended Equipment

Follow A Safety Program

Know The Equipment

Read and understand the DANGER, WARNING, CAUTION and NOTICE safety signs and other informational signs on the tractor and mower and in the manufacturer's operator's manual. Ask your supervisor or mower dealer to explain any information you do not understand. Failure to obey safety instructions could result in death or serious injury.



Read and Understand All Safety Signs

Make sure all the manufacturer's protective structures, guards, shields, screens and panels are in good repair, in place and securely fastened. Damaged, missing or weakened safety components can create a hazardous situation for you as the operator. **Never** remove or modify any safety components including thrown object shielding on a mower.

Know the following about your tractor and mower:

- Function, purpose and use of all controls.
- Correct operation speeds.
- Slope and uneven terrain capabilities and proper operation.
- Braking and steering characteristics.
- Turning radius and clearances.
- How to quickly stop equipment in an emergency.

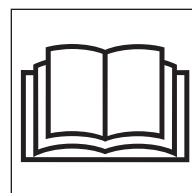

Read and Understand Manuals Before Operating

Prepare For Safe Operation

Check The Mower And Tractor Equipment

Before beginning your work day inspect the machine and have all systems in good operational condition.

WARNING! Prevent possible crushing injury from falling equipment. Hydraulic system or part failure could cause unsupported equipment to fall. **Do not go under raised equipment unless it is properly supported according to the operator's manual.**

- Perform daily and periodic service procedures as instructed by the equipment manufacturer.
- Check for loose, broken, missing or damaged tractor and mower parts. Repair or replace these parts.
- Check for proper tractor and mower attachments.
- Check for proper tractor and mower PTO rpm rating match.
- Check mower blade(s) condition. Replace severely worn, bent, gouged or nicked blades including the blade bolts and fasteners. Never straighten or weld on blades.
- Ensure thrown object shielding is properly installed and in good condition. Repair or replace if damaged or missing.

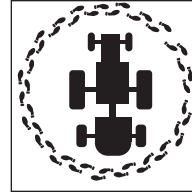

Walk-Around
Inspection

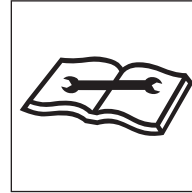

Maintain
Machine

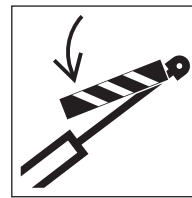

Read Manual –
Block Up or
Securely Support
Mower

Prepare For Safe Operation

- Check that all guards and shields are in place and that all equipment is in good operating condition. This includes PTO driveline, gearbox and implement guards and shields that are used for operator protection.
- Check for properly latched driveline yoke-end locking devices.
- Check for damaged or leaky tractor and mower hydraulic systems. Repair or adjust as needed.

WARNING! Hydraulic fluid under pressure can penetrate the skin or eyes and cause serious injury, blindness or death. Fluid leaks under pressure may not be visible.

Use a piece of cardboard or wood to find leaks, not your hand. Wear eye protection. If fluid is injected into the skin, it must be removed within a few hours by medical personnel familiar with this type of injury.

- Keep the operator platform surface clean and free of grease, oil, dirt, snow or ice. Steps and handholds must be clean and functional.
- Ensure work lights are kept clean (if equipped). Check that all lights work properly.
- Ensure the slow moving vehicle (SMV) sign, reflectors and warning lights are in good condition and can be clearly seen.

- Ensure all tools or loose objects are removed or securely fastened while operating the machine.
- Check all safety signs for clarity. Replace damaged signs.



Check for Missing/
Damaged Guards
and Shields



Check for
Leaks and Inspect
Hoses



Put Away
Tools

Prepare For Safe Operation

Know The Work Area

Before you operate the mower thoroughly inspect the work area. Walk around the area and inspect the surfaces you will travel on when using the mower.

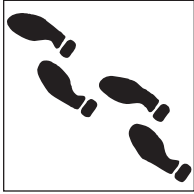

Walk
Around the
Worksite

Locate and avoid:

- Holes
- Drop-offs
- Obstacles (stumps)
- Excavations
- Standing water
- Deep mud
- Wet spots
- Soft soil
- Rough spots
- Power lines and apparatus
- Other utilities
- Any conditions which could cause collision, loss of control or tipover
- Steep slopes

Look for debris and obstacles by walking the area before you mow. Objects like wire, cable, rocks, tires, and metal objects that could damage or be thrown by the mower must be removed or marked clearly and avoided.

Correct unsafe conditions. Do not operate in problem areas where debris and obstacles cannot be removed or marked.

Analyze mowing area to determine:

- The most efficient mowing procedure.
- The height of the material to be mowed.
- Operating terrain conditions.
- How to best use forward mowing pattern.
- The potential for bystanders or passers-by to be exposed to thrown objects.

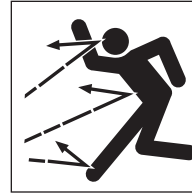

Remove or
Mark Debris and
Obstacles

Look Out For Others

Before starting equipment:

- Walk around the equipment.
- Check for anyone under, on or near the equipment.
- Clear everyone from these areas.
- Sound a warning.

Prepare For Safe Operation

Mount And Dismount Tractor Properly

Always use three-point contact when mounting or dismounting the tractor or mower. Face the machine when you enter or leave the machine. Three-point contact means that three out of four arms and legs are in contact with the machine at all times during mount and dismount.

Before mounting:

- Clean shoes and wipe hands. Clean steps and handholds of snow, ice, mud or oil.

During mounting and dismounting:

- Use handholds and step plates.
- Never grab steering wheels or controls for handholds.
- Never mount or dismount from a moving tractor.
- Never mount or dismount while carrying tools or objects that prevent three-point contact. Put parts or tools down. Maintaining proper contact, climb and then pick up the object.



Use
Three-Point
Contact



Clean Up
Slippery Areas

Prepare For Safe Operation

Tractor And Mower Controls Safety Test

Start the tractor following the specific procedures in the manufacturer's operator's manual. These procedures normally include:

- Fasten and adjust seat belt on your ROPS-equipped tractor.
- Check parking brake for engagement.
- Check PTO disengagement.
- Check all controls for Park position.
- Warn others in area before starting tractor.
- Start tractor following tractor manufacturer's recommended starting procedures.

WARNING! Avoid serious injury or death from unexpected machine movement. **Start the engine only from the operator's position. Never attempt to start the engine by shorting across starter terminals or reaching the key from the ground or outside the cab.**

After starting:

- Check all instruments, gauges and indicator lights for normal operation.
- Check all tractor controls, steering and brakes for proper function.

- Raise and lower mower to check for driveline bottoming out or engagement problems.
- Check the equipment for excessive vibration and unusual noises.

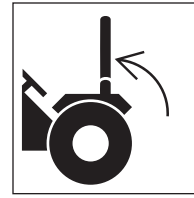

Use ROPS and Seat Belt



Start Only from Operator's Seat

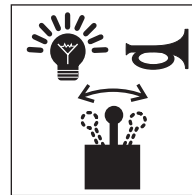

Check Instruments and Controls

Prepare For Safe Operation

- Use proper equipment shut down practices before inspecting equipment. Wait until all equipment motion has stopped before dismounting the tractor or mower.
- Do not operate mower unless tractor and mower are running properly. Place a "Do Not Operate" tag on the machine, remove the key and do not operate the mower until the problem is corrected.

Power Takeoff System

Be sure to operate the tractor at the mower's rated PTO rpm speed.

When operating tractors with transmission-driven PTO systems, a rotary mower will have a significant flywheel effect. The mower may continue to propel a tractor with a transmission-driven PTO system.

The tractor should be equipped and operated as follows:

- Install a driveline equipped with an over-running clutch.
- Give yourself sufficient maneuvering room and time by anticipating turns, stops and speed reductions.

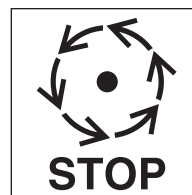

Do Not Dismount Until Equipment Motion Has Stopped

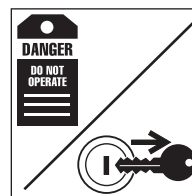

Use a "Do Not Operate" Tag

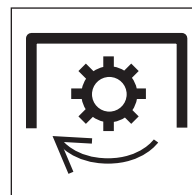

Use Proper PTO Speed

Prepare For Safe Operation

Hitching Mower To Tractor

Three-point hitch-mounted mowers:

- Refer to mower and tractor manufacturers' manuals.
- Place tractor's hydraulic power lift (rockshaft) selector lever in down position to avoid unexpected movement.
- Explain the hitching procedures to those operators who cannot read.
- Front-end weights may be needed to maintain steering control and front-end stability. Refer to the manufacturers' operator's manual(s).
- When backing the tractor up to the mower, NEVER allow anyone between the tractor and the mower.
- Attach the mower to the tractor three-point links and securely pin in position.
- Securely attach the driveline to the tractor PTO. Lower the master shield into place. Push and pull on the driveline to ensure it is locked onto the PTO shaft.

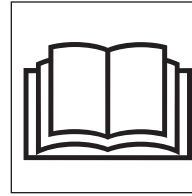

Read and Understand Manuals Before Operating



Maintain Proper Weight Distribution



No One Allowed Between Tractor and Mower



Avoid Entanglement, Use Guards and Shields

Prepare For Safe Operation

Pull-type hitch-mounted mowers:

- Refer to mower and tractor manufacturers' manuals.
- Remove three-point hitch quick coupler if equipped.
- Attach only to drawbar hitch.
- Adjust tractor drawbar length for 540 or 1000 rpm PTO operation.
- When backing the tractor up to the mower, NEVER allow anyone between the tractor and the mower.
- Properly attach the mower safety tow chain to the tractor.
- Securely attach the driveline to the tractor PTO. Push and pull on the driveline to ensure it is locked onto the PTO. Lower the master shield into place.
- Hook up the mower hydraulic hoses to the tractor.
- Make sure the wings, or raised mower decks, are supported by the cylinders before removing the transport locks. Never use force to release the transport or wing locks. The wings or deck could fall and crush you.

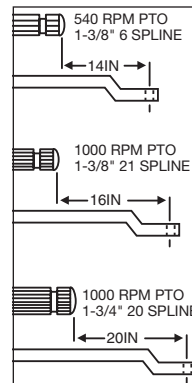

Tractor Drawbar Adjustment



Confirm Wings Are Supported Before Releasing Locks



Avoid Entanglement, Use Guards and Shields

Start Safely

Make The Right Start

Mow only in daylight or good artificial light conditions.

Avoid serious injury or death from mower-thrown objects or blade contact:

- Keep chain shields, flexible or solid deflector shields or discharge chutes in place and in good repair.
- Keep bystanders at least 300 ft (92 m) from mowing operation.
- Never direct mower discharge toward anyone.
- Keep hands, feet and other body parts away from rotating parts, blades and discharge openings.
- Do not operate mower in transport position.

Do not approach a mower until all motion has stopped.

Mower PTO drive engagement:

- Raise mower to maximum cutting height.
- Engage PTO at low engine rpm.
- Increase engine rpm to mower's rated rpm PTO speed.
- Lower mower to desired cutting height.
- Stop and shut down immediately if the mower strikes an obstruction.
- Inspect and repair any mower damage before resuming mowing.
- Do not operate mower with severe vibrations or with unusual noise.

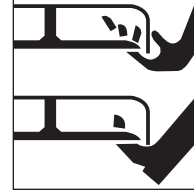

Rotating Blades –
Keep Away



Do Not Operate a
Damaged Mower

Mower-Thrown Objects

Depending on the designed purpose, mowers are designed to cut grass, weeds, brush and crops. The mower blades have been designed and tested for rugged use. The mower blades, however, are not intended to contact solid objects like rocks, concrete or metal. Such impact can cause broken objects to be thrown up to 300 ft (92 m). Bystanders should never be within 300 ft (92 m) of an operating rotary mower or within 100 ft (30 M) of a properly equipped disc mower.

Operate Safely

Mower shielding is designed to reduce the risk of thrown objects and must be properly maintained and in place during mowing operations.

The risk of serious injury or death from thrown objects can be significantly reduced by following three rules.

If all of these safety rules are not followed, the mowing operation must be stopped if anyone comes within the safety limit for the mower type.

First — Inspect the area prior to mowing and remove stones, branches, wire, cable, metal, glass and other solid objects before operating. Any objects that cannot be removed must be clearly marked and carefully avoided by the operator.

In non-crop areas with grass and weeds high enough to hide objects that could be struck by the blades, inspect the area and remove or mark large debris or obstacles.

Mow the area at an intermediate height. Inspect the area closely and remove or mark any remaining debris or obstacles. Mow again at desired final height.



Follow
All Mower
Safety Rules

Second — Mower-thrown object shielding must be used when operating near roads, parks, populated areas or other areas where thrown objects could injure bystanders or damage property. Follow the manufacturer's operator's manual.

Third — Cross diagonally when mowing through ditches, sharp dips, and drops. Raise the mower to prevent the mower blades from hitting the ground.

Operate Safely

Mower-Thrown Objects (continued)

Disc Mowers — When using a disc mower it is important to know the area to be mowed. If the operator has mowed the field before and is familiar with all obstacles that may be present, it is sufficient to watch ahead of the mower path for any additional objects that may have entered the field. Be ready to stop or avoid any objects that could be hazardous if thrown by the mower. If you plan to mow an unfamiliar field and it is next to a traveled road or people may be within 100 ft (30 m) of the mower you must inspect, and clean or mark the field.

Mowing In Reverse

Do not mow while traveling in reverse. Objects are more likely to be thrown and can travel further.

Shut off the PTO, wait for the blades to stop turning, raise the mower, and then back up.

Mow traveling in the forward direction.



**Do Not Mow
in Reverse**

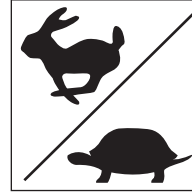

**Use Proper
Ground Speed**

Mowing Ground Speed

Proper ground speed depends on terrain conditions and grass type, density and height to be cut:

- Normal ground speed range is 2 to 5 mph.
- Use slower ground speed for mowing tall, dense grass.
- Use faster ground speed for mowing medium height, thin grass and under smooth terrain conditions.
- Use slower ground speed for mowing in rough, sloping or unfamiliar terrain.

Disc mowers are designed to use faster ground speeds for operating in fields clear of debris and surface hazards.

Operate Safely

Extremely Tall Grass Mowing

You may need to mow extremely tall, non-crop grass twice. (See page 13, **Mower-Thrown Objects**.)

First mowing pass:

- Shut the mower and tractor down using proper equipment shut down practice before dismounting tractor. (See page 18, **Proper Equipment Shut Down Practices**.)
- Inspect the area and remove or mark debris and obstacles.
- Cut grass higher (10-15 inches) to avoid hidden objects.

Second mowing pass:

- Shut the mower and tractor down using proper equipment shut down practice before dismounting tractor.
- Inspect the area and remove or mark debris and obstacles.
- Cut grass at desired height and, when possible, 90 degrees to the first mowing pass.

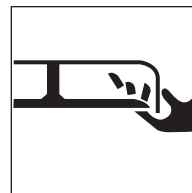

**Stop Blade
Before
Unclogging**

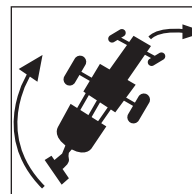

**Provide Adequate
Clearance for
Mower Swing**

Watch Equipment Clearances

Three-point hitch and side-mounted mowers have a larger turning arc than pull-type mowers. Allow sufficient clearance for mower swing while turning.

Do not allow bystanders near the tractor and mower when moving or transporting the tractor and mower.

Operate Safely

Under Mount Mower Safety Practices

When mowing with an under mount mower:

- Keep removable discharge chute in place and over discharge opening.
- Never stand on a mower housing when the tractor engine is operating.
- Distribute grass clippings with discharge chute facing mowed area.
- Before clearing a clogged mower or discharge chute, shut down your machine using proper equipment shut down practice. (See page 18, **Proper Equipment Shut Down Practices.**)

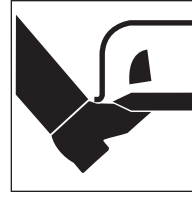

**Never Stand
on Mower –
Keep Away**

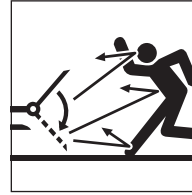

**Keep Chute
in Place**

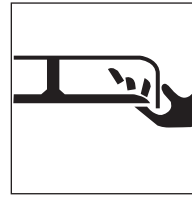

**Stop Blade
Before
Unclogging**

Operate Safely

Wing Or Boom Mower Overhead Obstruction Hazards And Risks

Check for overhead obstructions with raised wing or boom mowers to avoid serious injury or death by contact with:

- Electrical power lines and apparatus.
- Low tree limbs.
- Other overhead obstructions.
- Maintain specified distance from power lines and apparatus. Never approach energized power lines or apparatus with any part of your machine unless all local, state/provincial and federal (OSHA) required safety precautions have been taken. Use extreme caution.

DANGER! Avoid electrocution or serious injury from contact with or inadequate clearance to energized power lines or apparatus. **Do not allow the machine or attachment to approach or contact any power line. Do not approach or touch any machine in contact with a power line.**

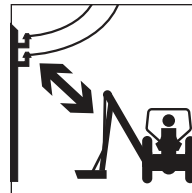

**Do Not
Approach Energized
Power Lines**

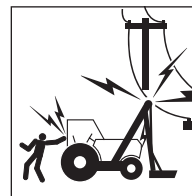

**Stay Clear
of Energized
Equipment**

Operate Safely

Wing And Side Mount Mowers Safety Practices

Raised wing positions reduce shielding protection and increases the thrown object and blade contact hazard risks.

Avoid possible serious injury or death by thrown objects or blade contact from raising and lowering wings during mowing operations:

- Do not mow with bystanders within 300 ft (92 m) of the mower.
- Be sure no one is near mower while raising or lowering wings.
- Shut off the PTO and wait for all rotating elements to stop before raising the mower deck or wing section.
- Only raise wing to clear objects in the mowing path or to match ground slope.
- Lower raised wing to ground after clearing object or ground slope conditions.
- Stop mowing if anyone approaches within 300 ft (92 m) of mowing area.

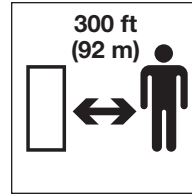

Keep Bystanders Away from Mowing Area

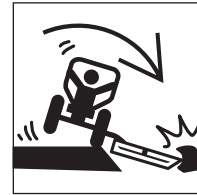

Avoid Hitting Obstructions

Ditch Bank Mowing Safety Practices

Use extreme care when mowing ditch banks. Watch for washouts, eroded areas and mowing obstructions along the ditch banks. Hitting obstructions with side-mount or boom mowers may swerve the tractor's front end toward the ditch.

Operate Safely

Raised wing and boom mower ditch bank operations may reduce the mower's thrown object shielding effectiveness for the mower operator's protection.

- Use enclosed ROPS cabs, special protective enclosures and other operator shielding available from the manufacturer when performing these operations.
- Inspect mowing area and remove or mark all foreign objects and debris to be avoided by mower.

Uneven Terrain Mowing Safety Practices

Tractor and mower stability is reduced on slopes and uneven terrain.

As in all conditions when mowing, use tractors equipped with ROPS and seat belt. **Make sure the ROPS are raised and locked in place and always wear your seat belt.**

Prevent tractor and mower overturns and maintain equipment stability control:

- Review tractor and mower operator's manuals for operating safety practices on slopes and uneven terrain conditions. Explain the practices to those users and operators who cannot read.
- Avoid extremely steep slope operations.

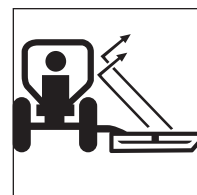

Use Enclosed ROPS Cabs or Protective Enclosures

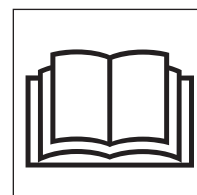

Read and Understand Manuals Before Operating

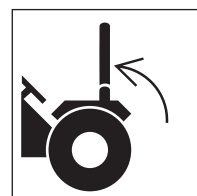

Use ROPS and Seat Belt

Operate Safely

Uneven Terrain Mowing Safety Practices (continued)

- Use extreme care to maintain control over the equipment when operating in these conditions.
- Increase tractor stability by adding wheel weights, ballast and increasing wheel spacing to maximum. Refer to operator's manual for recommendations.
- Maintain minimum ground speed.
- Make wide and gradual turns.
- Avoid sudden starts, stops, and turns when operating up, down, or across slopes.
- **Do not** raise rear-mount or side-mount mowers or mower wings from the ground during these operations.
- Keep alert for holes, bumps, ruts, rocks, stumps or other obstructions that could overturn the machine.
- Avoid slippery ground conditions that could cause loss of control and overturn of tractor and mower.
- Avoid bottoming and striking the ground by diagonal crossing of sharp dips and drops.

Use extreme care in maintaining equipment stability during all uneven terrain and slope mowing operations. You are the final judge as to any slope that can be safely negotiated.

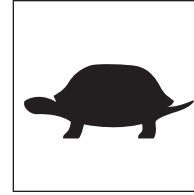

Maintain Control, Use Low Speeds



Add Ballast, Widen Wheel Spacing



Avoid Ruts, Bumps, Holes

Operate Safely

Road Transport Safety Practices

Before operating on public roads:

- Refer to tractor and mower manufacturers' operator's manuals for instructions.
- Explain the instructions to those users or operators who cannot read.
- Check local regulations for required equipment markings, lights, flashers, etc., while traveling on public roads. Lights are required on mowers that obscure tractor taillights and/or warning lights.
- When transporting the mower on a trailer, follow the manufacturer's detailed instructions for loading, tying down and unloading the mower.

Before transporting on public roads:

- Disengage PTO power to mower.
- Raise mower into transport position and engage transport lock.
- Lock mower wings in the transport position with approved locking devices.
- Attach towing safety chain between pull-type mower and tractor.
- Make sure lights, warning lights and reflectors are in place and visible.

- Check SMV (Slow-Moving Vehicle) emblem for visibility to any rear-approaching vehicle.

While transporting on public roads:

- Obey all local traffic regulations.
- Approach intersections with caution.
- Observe speed and traffic control signs.
- Avoid panic stops and sharp turns.

Be a courteous operator and pull over periodically and allow traffic to pass.

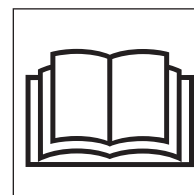

Read and Understand Manuals Before Operating

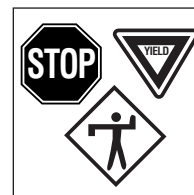

Obey Traffic Regulations

Park Safely

Parking Safety Practices

- Use designated or out-of-traffic areas.
- Use firm level ground locations.
- Set parking brake.
- Lower raised equipment to ground.

Shut down the mower and tractor using proper equipment shut down practice before dismounting tractor. (See page 18, **Proper Equipment Shut Down Practices.**)

Sloping ground parking locations:

- Position equipment across slope.
- Set parking brakes.
- Lower raised equipment to ground.
- Block tractor wheels.

Before temporarily parking and leaving disabled equipment near traffic areas:

- Remove equipment from public roads.
- Set out warning flags.
- Use tractor flashing warning lights.

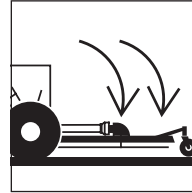

Shut Down Safely

Proper Equipment Shut Down Practices

Make proper equipment shut down an important habit.

Properly shutting down a tractor and mower can prevent accidents from occurring when the mower is left unattended. Shut down the mower following the specific procedures in the manufacturer's operator's manual.

These procedures will normally include:

- Reduce engine speed.
- Disengage PTO clutch and transmission drive.
- Idle engine for gradual cooling.
- Place all controls in PARK position.
- Set the parking brake.
- Lower mower to ground.
- Lower wings of wing mowers to ground.
- Shut off engine, lock ignition and remove key from the machine and take it with you.
- Wait for all moving parts to stop before dismounting.
- Relieve hydraulic pressure by moving hydraulic controls several times in all directions.
- Lock anti-vandalism covers and closures, if equipped, when equipment is unattended.
- Dismount carefully maintaining three-point contact.

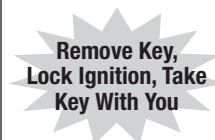
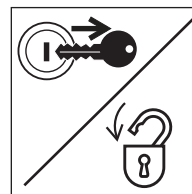
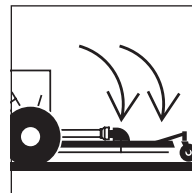
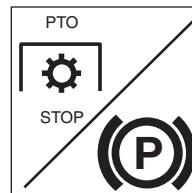

Shut Down Safely

Dismounting Properly

- Never dismount from moving equipment.
- Never jump from any machines.
- Dismount carefully.
- Check for slippery steps.
- Keep feet and hands away from controls.
- Use handholds and steps during dismount.
- Face machine and use three-point contact (2 hands and 1 foot or 2 feet and 1 hand).

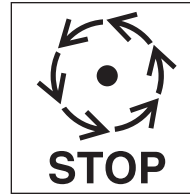

Wait for
Moving Parts
to Stop



Use Three-Point
Contact,
Face Machine

Perform Maintenance Safely

Maintain Your Equipment

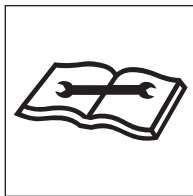

Maintain
Equipment

Be sure to maintain the equipment according to manufacturer's instructions. Regularly check the operation of the protective and safety devices.

Do not perform any work on a tractor or mower unless you are authorized and qualified to do so.

If you have been authorized to do maintenance, **read the operator's and service manuals.** Study the instructions; check the lubrication charts; examine all the instruction messages on the machine. Maintenance can be hazardous unless performed properly. Be sure you have the necessary skill, information, correct tools and equipment to do the job.

WARNING! Do not modify equipment or add components not approved by the manufacturer. Use parts, lubricants and service techniques recommended by the manufacturer.

Mower Parts And Your Safety

Mower manufacturers use specific fasteners and specially designed parts to meet mowing operations requirements. Critical parts (self-locking blade bolts, blades, pins, shields and other special items) have specific strength, design and fit requirements for the make and model mower you are using.

Avoid possible death or serious injury from unapproved parts or modifications:

- Do not substitute common hardware for original manufacturer's blade bolts or other special part items.
- Do not substitute for blades, pins, shields or other critical parts.
- Do not use higher strength bolts to replace original manufacturer's shear bolts.

Perform Maintenance Safely

Prepare Yourself

Wear personal protective clothing and Personal Protective Equipment (PPE) issued to you or called for by job conditions. You must **ALWAYS** wear safety glasses with side shields.

You may also need:

- Hard hat
- Safety shoes
- Safety glasses, goggles or face shield
- Apron and gloves
- Hearing protection
- Welding helmet or goggles
- Respirator or filter mask

Wear whatever is needed—don't take chances.

Keep hands—and clothing—away from all moving parts. Don't wear dangling ties, loose sleeves, rings, watches, or long hair.

WARNING! Prevent death or serious injury from entanglement. **Do not wear loose clothing or accessories. Stay away from all rotating components when the engine is running.** Contact, wrapping or entanglement with rotating or moving parts could result in death or serious injury.



Avoid Rotating Parts



Avoid Pinch Points

Perform Maintenance Safely

Wear a rubber apron and rubber gloves when working with corrosives. Wear gloves and safety shoes when handling wooden blocks or sharp-edged metal.

Always use safety glasses, goggles or a face shield. They provide eye protection from fluids under pressure, during grinding and while servicing batteries. Protection is also needed from flying debris, liquids and loose material produced by equipment, tools and pressurized air/water.

Wear a face shield and follow manufacturer's instructions when you disassemble spring-loaded components or work with battery acids. Wear a welding helmet or goggles with a shaded filter when you weld or cut with a torch.

Do not sand, grind, flame-cut, braze or weld without a NIOSH-approved respirator or appropriate ventilation. If welding is required on this machine, refer to the manufacturer's operator's or service manuals or consult your equipment dealer for proper procedures.

Keep pockets free of all objects that could fall out—and drop into machinery.

Handle tools and heavy parts sensibly—with regard for yourself and other persons. Lower items—don't drop them.



Clean Slippery Surfaces



Ventilate Work Area

Prepare The Work Area

- Position the mower in a level area out of the way of other working equipment.
- Make sure there is adequate light, ventilation and clearance.
- Remove oil, grease or water to eliminate any slippery surfaces.
- Clean around the area to be serviced to minimize contamination.

Perform Maintenance Safely

Prepare The Machine

Stored energy sources (electrical, mechanical, hydraulic, pneumatic, chemical, thermal, etc.) must be controlled or reduced to a practical minimum before performing any maintenance, repair or service procedures.

Safety practices to prevent potential injuries from energy-releasing sources:

- Disengage PTO before shutting off engine.
- Place controls in PARK or NEUTRAL before shutting off engine.
- Set parking brake or block wheels.
- Allow all moving parts to stop.
- Lower mower to ground.
- Lower wings to ground on wing mowers.
- Shut off tractor engine.
- Relieve hydraulic system pressure by moving controls several times in all directions.
- Lock ignition, remove key and take it with you.
- Look and listen for evidence of moving parts before dismounting.
- Securely support or block up mower before working underneath mower or other lifted components.

- Securely support, block up, or lock up mower wings with approved locking devices before working near or underneath a wing mower.
- Relieve pressure before disconnecting or disassembling any pressurized system.
- Block or relieve spring pressure before disassembling any spring-loaded mechanism.
- Securely support or block up any raised machine component before working on it.
- Avoid flames, sparks, or smoking near any fuel, hydraulic fluid or other flammable material such as mowing debris.



Prepare
Machine Systems
for Service

Perform Maintenance Safely

Attach a “DO NOT OPERATE” warning tag to the control levers and remove the ignition key if the mower should not be operated. Take the key with you.

Install approved support device(s) when working under or near raised equipment.

WARNING! Unsupported raised mowers or other equipment may drop unexpectedly. **Never go under equipment when raised unless supported by an approved support device(s).** Death or serious crushing injury could result from falling equipment.

Remove only guards or covers that provide access to the area being serviced. Replace all guards and covers when work is complete.

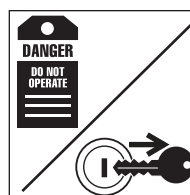

Use a
“Do Not Operate”
Tag



Use
Approved
Support Device



Replace
All Guards

Perform Maintenance Safely

Use Proper Ventilation

If it is necessary to run an engine in an enclosed area, remove the exhaust fumes from the area with an exhaust pipe extension. If you do not have an exhaust pipe extension, make sure you open the doors and get outside air into the area.

WARNING! Prevent possible injury. **Never work on machinery with the engine running unless instructed by the manufacturer's manuals for specific service.**

WARNING! Never operate any type of engine without proper ventilation—EXHAUST FUMES CAN KILL.

Use Jacks And Hoists Carefully

Safety stands or blocks must be located on a rigid part of the mower. Do not position stands under axles or wheel supports that may rotate.

If you must work beneath raised equipment, always use wood—**not concrete**—blocks, jack-stands or other rigid and stable supports. When using jacks or hoists always be sure they are adequately supported.

WARNING! Prevent possible crushing injury. **Never use concrete blocks for supports.** They can collapse under even light loads.

Make sure the hoists or jacks you use are in good repair. Never use jacks with cracked, bent, or twisted parts. Never use frayed, twisted or pinched cables. Never use bent or distorted hooks.

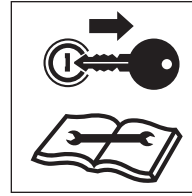

Remove Key and Read Maintenance Manual

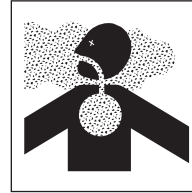

Ventilate Work Area



Use Proper Support for Raised Equipment

Perform Maintenance Safely

Common Maintenance Safety Practices

Fuel Hazards

WARNING! Always use approved fuel containers and/or dispensing equipment.

Fuels are flammable, so observe these practices to reduce the possibility of a serious accident.

- Shut off engine and ignition during refueling.
- Always ground the fuel nozzle against the filler neck to avoid sparks.
- Keep sparks and open flames away from fuel.
- Do not smoke while refueling or when handling fuel containers.
- Do not cut or weld on or near fuel lines, tanks or containers.
- Do not overfill the tank or spill fuel. Clean up spilled fuel immediately.

Engine Coolant Hazards

Liquid cooling systems build up pressure as the engine gets hot, so **use extreme caution before** removing the radiator cap.

Be sure to:

- Stop the engine and wait for the system to cool.
- Wear protective clothing and safety glasses.
- Turn the radiator cap slowly to the first stop to allow the pressure to escape before removing the cap completely.



No Smoking and No Open Flames

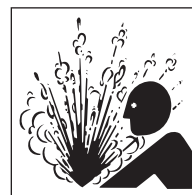

Remove Radiator Cap Slowly

Perform Maintenance Safely

Hydraulic System Hazards

The hydraulic system is under pressure whenever the engine is operating and may hold pressure even after the engine is shut off. Cycle all hydraulic controls including the auxiliary hydraulic control after the engine is shut down. Relieve trapped pressure in the lines after the attachments are shut down and resting on the ground.

During inspection of the hydraulic system:

- Wait for fluid to cool before disconnecting the lines. Hot hydraulic fluid can cause SEVERE BURNS.
- **Do not** use your hand to check for leaks. Instead, use a piece of cardboard or paper to search for leaks.
- Wear appropriate eye protection. Hydraulic fluid can cause permanent eye injury.

WARNING! Hydraulic fluid under pressure can penetrate the skin or eyes and cause serious injury, blindness or death. Fluid leaks under pressure may not be visible.

Use a piece of cardboard or wood to find leaks, not your hand. Wear a face shield or safety goggles for eye protection. If fluid is injected into the skin, it must be removed within a few hours by medical personnel familiar with this type of injury.

When venting or filling the hydraulic system, loosen the filler cap slowly and remove it gradually.

Never reset any relief valve in the hydraulic system to a pressure higher than recommended by the manufacturer.

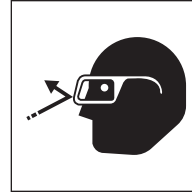

Wear
Eye Protection



High Pressure
Fluid Can Inject
Into the Body

Perform Maintenance Safely

Electrical System Hazards

Before working on the electrical system, disconnect the battery cable(s).

- Remove the battery negative (-) cable(s) first.
- When reconnecting the battery, connect the battery negative (-) cable(s) last.

The liquid in batteries contains acid, which is a POISON and can cause SEVERE CHEMICAL BURNS.

Avoid Injury

- Wear a face shield to prevent contact with your eyes.
- Wear chemical-resistant gloves and clothing to keep electrolyte off your skin and regular clothing.

WARNING! Electrolyte will damage eyes or skin on contact. **Always wear a face shield to avoid electrolyte in eyes.** If electrolyte contacts eyes, flush immediately with clean water and get medical attention.

Wear chemical-resistant gloves and protective clothing to keep electrolyte off skin. If electrolyte contacts exposed skin or clothing, wash off immediately

with clean water. **If electrolyte is ingested**, seek medical attention immediately. NEVER give fluids that would induce vomiting.

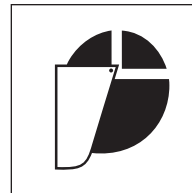

Wear
Face Protection

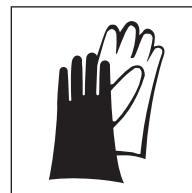

Wear
Protective
Clothing

Perform Maintenance Safely

Avoid Explosion

WARNING! Avoid possible serious injury from explosion. Lead-acid batteries produce extremely explosive gases especially when being charged. **Keep arcs, sparks, flames and lighted tobacco away.**

- Do not smoke near batteries.
- Keep arcs, sparks and open flames away from batteries.
- Provide adequate ventilation.

Never check the battery by placing a metal object across the battery posts — the resulting spark could cause an explosion.

WARNING! Avoid possible serious injury from battery explosion. **Do not charge a battery or boost start the engine if the battery is frozen.** Warm to 60°F (15.5°C) or the battery may explode and could cause serious injury.

Safety rules during battery boost starting:

- Follow the instructions for proper “battery boost starting” as specified in the manufacturer’s manual.
- Be sure the machines are not touching.

- Observe the polarity of the batteries and connections.
- Make the final cable connection to the engine or the furthest ground point away from the battery. Never make the final connection at the starter or dead battery—sparks may ignite the explosive gases present at the battery.
- When disconnecting cables after jump starting, remove the cables in reverse order of connection (e.g., final connection first).

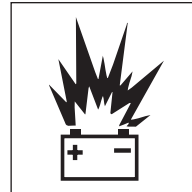

Avoid Sparks and Open Flames Near Batteries

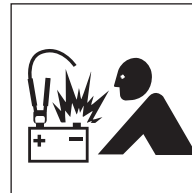

For Boost Starting Observe Polarity and Make Final Connection at Ground Point

Perform Maintenance Safely

Tire And Wheel Maintenance

Check your tires and wheels daily because the stability of the tractor and mower can be dramatically affected by tire pressure or damage to tires or wheels.

Check tires for:

- Correct pressure.
- Cuts and bulges.
- Nails or other punctures.
- Uneven or excessive wear.
- Condition of valve stems and caps.

Check wheels for:

- Damage to the rims.
- Missing or loose lug nuts or bolts.
- Misalignment.

All tire service should be performed by a qualified tire service center or by an authorized service person who has been properly trained in the procedures and use of safety equipment designed for tire servicing.

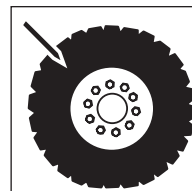

Check Tires and Wheels for Damage

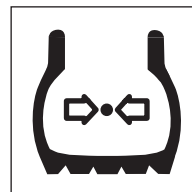

Maintain Proper Tire Pressure

Perform Maintenance Safely

Tire And Wheel Maintenance (continued)

WARNING! The types of wheels and tires usually found on this equipment require special care when servicing to prevent death or serious injury.

Do not inflate the tires above the recommended pressure. Be sure to replace tire ballast if equipped. See manufacturer's specifications for ballast requirements.

Keep wheel lug nuts tightened to manufacturer's recommendations.

A rise in tire pressure during operation is normal, and should NOT be reduced.

Never reinflate a tire that has been run flat or seriously underinflated without removing the tire from the wheel. Have the tire and wheel closely inspected for damage before remounting.

When adding air to a tire, do so from a distance. Use a long hose with self-attaching chuck. Always stand behind tread when adjusting tire pressure.

Do not inflate tires with flammable gases or from systems using an alcohol injector.

Never cut or weld on a wheel with an inflated tire mounted on it. This could cause explosive decompression.

Check that the tire size and wheel are correctly matched.

When replacing the tires, ensure the tires are of the appropriate rating specified by the manufacturer.

Tires should not be operated at speeds higher than their rated speed. Most agricultural tires are rated for 20mph maximum speed.

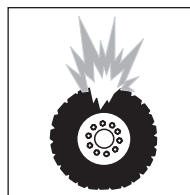

Perform Maintenance Safely

Complete Service And Repairs Before Machine Is Released

Tighten all bolts, fittings, and connections to torques specified by the manufacturer.

Install all guards, covers, and shields after servicing. Replace or repair any damaged parts. Refill and recharge pressure systems only with manufacturer approved or recommended fluids.

Start the engine and check for leaks. (See page 23, **Hydraulic System Hazards**.) Operate all controls to make sure the tractor and mower are functioning properly. Test the machine if necessary. After testing, shut down and check the work you performed. Are there any missing cotter pins, washers, locknuts, etc.? Recheck all fluid levels before releasing the equipment for operation.

All parts should be inspected during repair and replaced if worn, cracked or damaged. Excessively worn or damaged parts can fail and cause injury or death.

Replace any damaged or illegible safety signs.



Mower Blade Maintenance

Do not take chances using damaged or bent blades. The mower manufacturers from the Association of Equipment Manufacturers (AEM) and the Farm Equipment Manufacturers Association (FEMA) advocate that you DO NOT reuse, straighten, hard face or weld mower blades. Death or serious injury could result if a broken blade is thrown from a mower.

Perform Maintenance Safely

Mower Blade Maintenance (continued)

– How are mower blades made?

Mower blades are made of high strength alloy spring steel. They are hot-forged and shaped to meet the manufacturer's individual specifications, then heat treated and tempered to a high strength, ductile state to reduce the possibility of breaking while mowing. Blades are tested to ensure they meet strength, hardness, and ductility standards. If a blade fails to meet any of these specifications, it will not be used on the mower.

– What happens when a mower blade bends?

It takes a great amount of impact force to bend the blade. This impact force often results in the blades being gouged or chipped. After a blade is damaged by a gouge or chip a blade failure is much more likely to occur. When a blade is severely bent, a microscopic crack may be created in the blade. Straightening the blade does not remove or repair this crack, but may cause additional cracks. Additional stresses during mowing operations can result in an unexpected blade failure.

- **Avoid bending blades.** Help prevent mower blades from bending or cracking by avoiding contact with solid objects. Mower blades are intended to cut grass, shrubs, woody vegetation, and small trees and limbs. They are not intended to contact solid objects such as rocks, concrete, or steel posts. Inspect the area prior to mowing. Remove or clearly mark any solid objects and mow around them.
- **Replace damaged blades!** Inspect the mower blade(s) daily or after hitting any solid object. If a mower blade becomes damaged (bent, gouged, cracked) or worn more than 25 percent of the original size, it should be removed and replaced with a new blade. Always use the original manufacturer's blades. Aftermarket brand blades may not meet the mower manufacturer's strength, hardness and ductility requirements.
- **Do not take chances mowing with damaged or bent blades.** Using a damaged or straightened mower blade can result in the blade breaking and being thrown into the operator or a bystander causing death or serious injury. The price of a new blade is small compared to the potential for the serious injury that could result from a bent or broken blade being thrown from the mower.

Final Word To The User

You have just finished reading the AEM Industrial and Agricultural Mower Manual. It is impossible for this manual to cover every safety situation that you may encounter on a daily basis. Your knowledge of these safety precautions and your application to the

basic rules of safety will help to build good judgment in all situations. Our objective is to help you develop, establish and maintain good safety habits to make operating an Industrial and Agricultural Mower easier and safer for you.

This manual is another in a series on the safe operation of machinery published by AEM. Many pictorials in this safety manual can be found and downloaded at <http://pictorials.aem.org>. For additional publications visit our website at www.safetymaterials.org.



ASSOCIATION OF
EQUIPMENT MANUFACTURERS

e-mail safetymaterials@aem.org
www.aem.org

CORTADORA
DE CÉSPED INDUSTRIAL/
PARA AGRICULTURA

www.aem.org



MANUAL DE SEGURIDAD

PARA EL PERSONAL DE OPERACIONES Y MANTENIMIENTO

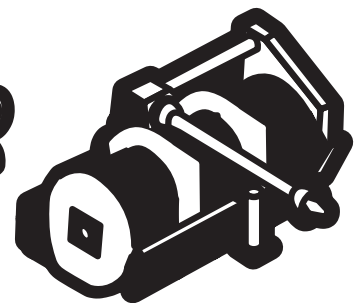
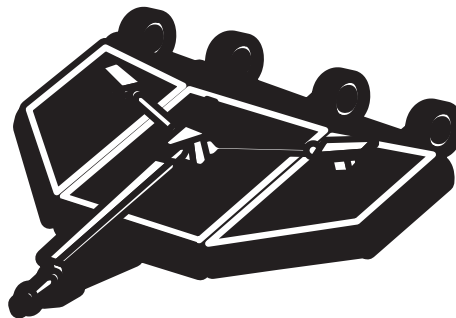
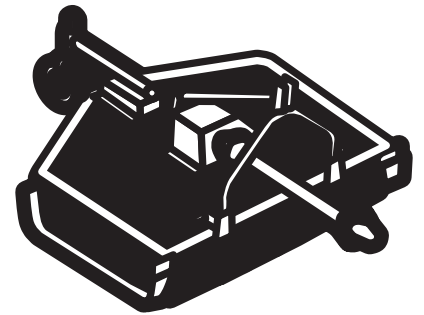
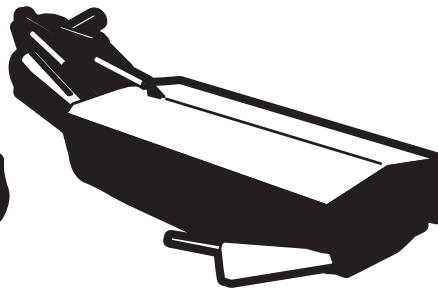
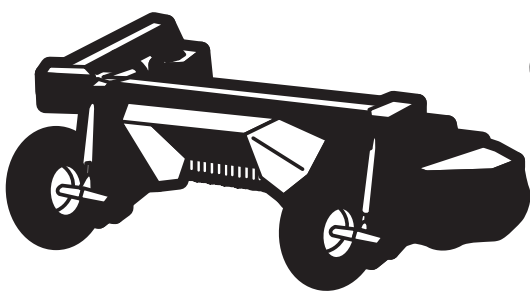

FORMULARIO IAMSE-1009
Impreso en los EE.UU.

Contenido

Reconocimiento	2
Introducción	2
Alertas de seguridad	3
Palabras para el usuario/operador	3
Cortadora de césped industrial/para agricultura	4
Cumplimiento del programa de seguridad	5
Preparación para una operación segura	9
Arranque con seguridad	13
Operación con seguridad	13
Estacionamiento seguro	18
Apagado con seguridad	18
Realización de mantenimiento con seguridad	19
Palabras finales para el usuario	26

Reconocimiento

Deseamos reconocer las contribuciones de los miembros del Consejo de Fabricantes de Cortadoras de Césped Industriales/para Agricultura para la preparación de este Manual de seguridad.

AVISO DE PROTECCIÓN DE COPYRIGHT

Copyright, 2010, por la Asociación de Fabricantes de Equipos (Association of Equipment Manufacturers). Todos los derechos reservados. Queda prohibida la reproducción o difusión parcial o total de este trabajo por cualquier medio sin consentimiento previo por escrito de la Asociación de Fabricantes de Equipos.

Copyright 2010© AEM (Asociación de Fabricantes de Equipos)
Revisado el 01/03, 09/10

Introducción

Este manual de seguridad está destinado a señalar algunas de las situaciones de seguridad básicas que pueden surgir durante la operación y el mantenimiento normales de la máquina y a instruirlo en prácticas de seguridad para manejar estas condiciones. Este manual **NO** sustituye los manuales del operador del fabricante de la cortadora de césped.

Puede ser necesario tomar precauciones adicionales o algunas de las instrucciones pueden no ser pertinentes, dependiendo del equipo, los accesorios y las condiciones del sitio de trabajo o del área de servicio. El fabricante no tiene control directo sobre la aplicación, la operación, la inspección o el mantenimiento del equipo. Por lo tanto, es **SU** responsabilidad utilizar prácticas de seguridad correctas en estas áreas.

La información que se proporciona en este manual complementa la información específica sobre la máquina que contienen los manuales del operador del fabricante. Puede haber otra información que afecte la operación segura de la máquina en los letreros de seguridad o en los requisitos del seguro, programas de seguridad y capacitación del empleador, códigos de seguridad, leyes federales, locales, estatales o provinciales, reglas y ordenanzas.

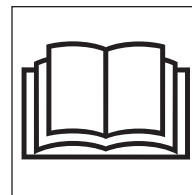

Lea y asegúrese
de comprender los
manuales antes
de comenzar la
operación



¡IMPORTANTE! Antes de hacer funcionar la cortadora de césped, asegúrese de contar con los manuales del operador del fabricante para esta máquina y todos los accesorios. Si faltan los manuales del fabricante, solicite manuales de repuesto a su empleador, al concesionario de los equipos o directamente al fabricante. Guarde este manual de seguridad y los manuales del fabricante con la máquina en todo momento. Lea y asegúrese de comprender todos los manuales.

Se encuentra disponible el video AEM Mower Safety Practices (Prácticas de seguridad para la cortadora de césped de AEM) para capacitar y reforzar prácticas de seguridad correctas. Se alienta a los operadores a ver periódicamente el video de seguridad.

Alertas de seguridad

Símbolo

Este símbolo de alerta de seguridad significa: **“¡ATENCIÓN! ¡MANTÉNGASE ALERTA! ¡SU SEGURIDAD ESTÁ EN RIESGO!”**

El símbolo de alerta de seguridad identifica mensajes de seguridad importantes sobre el equipo, sobre letreros de seguridad, en manuales u otros lugares. Cuando vea este símbolo, manténgase alerta ante la posibilidad de muerte o lesiones personales. Siga las instrucciones del mensaje de seguridad.



- Motivos por los cuales la seguridad es importante:
- Los accidentes provocan discapacidad y muerte.
 - Los accidentes cuestan.
 - Los accidentes pueden evitarse.

Palabras indicativas

Las palabras indicativas son palabras distintivas que típicamente se encontrarán en letreros de seguridad de la cortadora de césped y otros equipos del sitio de trabajo. Estas palabras también se pueden encontrar en este manual y en los manuales del fabricante. Están destinadas a alertar al operador sobre un riesgo y el grado de gravedad del riesgo.



DANGER (PELIGRO) indica una situación riesgosa que, si no se evita, resultará en una lesión grave o la muerte.



WARNING (ADVERTENCIA) indica una situación riesgosa que, si no se evita, podría resultar en una lesión grave o la muerte.



CAUTION (PRECAUCIÓN) indica una situación que, si no se evita, podría resultar en lesiones leves o moderadas.



NOTICE (AVISO) indica un mensaje de daños a la propiedad.

Palabras para el usuario/operador

Es **SU** responsabilidad leer y asegurarse de comprender el manual de seguridad y los manuales del fabricante antes de hacer funcionar esta máquina. Este manual de seguridad lo lleva paso a paso a través de su día de trabajo.

El reconocimiento de los riesgos y la prevención de accidentes dependen de que usted esté alerta, sea cuidadoso y se capacite correctamente para la operación, el transporte, el mantenimiento y el almacenamiento de este equipo.

Se han suministrado gráficos útiles para comprender el texto.

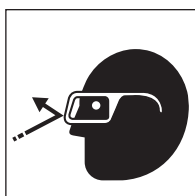

Lea y asegúrese de comprender todos los letreros de seguridad

Recuerde que **USTED** es la clave de la seguridad. Las prácticas de seguridad correctas lo protegen no sólo a usted sino también a las personas que lo rodean. Estudie este manual y los manuales del fabricante para su máquina en particular. Transfórmelos en una parte activa de su programa de seguridad. Tenga presente que este manual de seguridad está escrito para cortadoras de césped industriales/para agricultura.

Contáctese con el fabricante del equipo si le queda alguna pregunta sobre la operación segura después de estudiar los manuales del operador del fabricante y este manual de seguridad.

Tome todas las demás precauciones habituales y acostumbradas para un trabajo seguro y, sobre todo:

RECUERDE:

¡LA SEGURIDAD DEPENDE DE USTED!

¡PUEDE EVITAR LESIONES GRAVES O MUERTE CAUSADAS POR PRÁCTICAS LABORALES NO SEGURAS!

Cortadora de césped industrial/para agricultura

Tipos de cortadora de césped industrial/para agricultura

Las cortadoras de césped se usan para recortar pasturas, desmenuzar residuos de cultivos, cortar arbustos, realizar desbroce pesado, cortar la hierba en vías de agua, derechos de paso, costados de caminos o autopistas. Además, estas cortadoras se usan para cortar la hierba y otras plantas en zonas públicas como parques y cementerios.

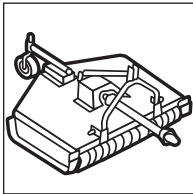

Giratorio

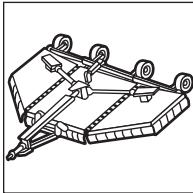

Giratorio con lateral plegable

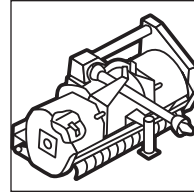

Triturador

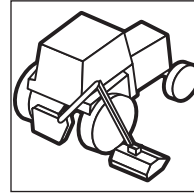

Aguilón

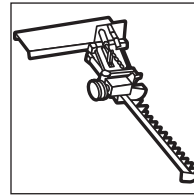

Barra en forma de hoz

Cortadora de césped industrial/para agricultura

Tipos de cortadora de césped de disco para agricultura

Las cortadoras de césped de disco están diseñadas y equipadas para cortar cultivos de heno a mayor velocidad de desplazamiento.

Las cortadoras/acondicionadoras de disco cortan y acondicionan los cultivos.

Las formadoras de hileras autopropulsadas cortan el heno y lo acondicionan en hileras.

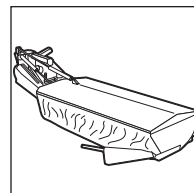

Cortadora de césped de disco

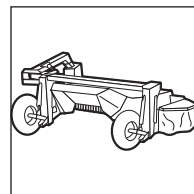

Cortadora/acondicionadora de disco

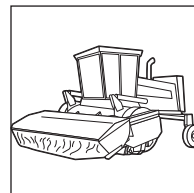

Formadora de hileras autopropulsada

Cumplimiento del programa de seguridad

Protéjase a sí mismo

Use la ropa de protección personal y los equipos de protección personal (PPE) que se le proporcionen o que requieran las condiciones del trabajo. **SIEMPRE** debe usar gafas de seguridad con escudos laterales.

Puede necesitar también:

- Casco
- Calzado de seguridad
- Antiparras de seguridad o protección facial
- Guantes gruesos
- Protección para oídos
- Indumentaria reflectiva
- Indumentaria impermeable
- Respirador o máscara con filtro

Use la ropa necesaria; no corra ningún riesgo.

¡ADVERTENCIA! Evite lesiones graves o muerte por enredos. **No use ropa floja ni accesorios. Ate el cabello largo. Manténgase alejado de todos los componentes giratorios cuando el motor está en funcionamiento.** El contacto, el enrollado o el enredo con piezas giratorias o móviles podrían resultar en lesiones graves o la muerte.



Evite quedar enredado

Cumplimiento del programa de seguridad

- Lea, asegúrese de comprender y siga las instrucciones escritas del fabricante que se encuentran en el manual del operador y en los letreros de seguridad sobre la cortadora y el tractor.
- Obtenga capacitación para la operación de la cortadora y el tractor.
- Aproveche los programas de capacitación que se ofrecen en su zona.
- Solicítele al distribuidor de equipos o al supervisor que le explique cualquier información que no comprenda.
- Explique las instrucciones escritas de los manuales del operador y los letreros de seguridad a los usuarios u operadores que no puedan leerlas.
- Inspeccione la cortadora y el tractor diariamente antes de hacerlos funcionar. Asegúrese de que todas las guardas se encuentren en su lugar y de que el equipo funcione correctamente.
- Nunca fume mientras lo está manejando. Nunca llene el depósito de combustible con el motor en funcionamiento o cerca de una llama abierta.
- Asegúrese de tener visibilidad adecuada e iluminación suficiente.
- Sepa cuáles son los puntos donde puede quedar atrapado y las partes giratorias. Su conocimiento puede evitar accidentes.
- Nunca intente hacer funcionar los controles, excepto desde el asiento del operador. Las funciones controladas de manera incorrecta pueden producir el movimiento imprevisto de la máquina y resultar en lesiones graves o muerte.
- Apague la cortadora y el tractor antes de descender. (Consulte la página 18, **Prácticas correctas de apagado de los equipos.**)

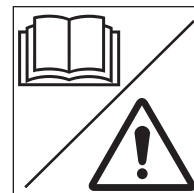

Lea, asegúrese de comprender y siga las indicaciones de los manuales y los letreros de seguridad



Evite las partes giratorias

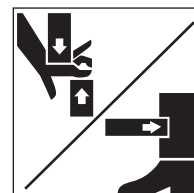

Sepa cuáles son y evite los puntos donde pueda quedar atrapado

Cumplimiento del programa de seguridad

Evite las lesiones provocadas por equipos elevados

Evite posibles lesiones de aplastamiento por caídas de la cortadora u otros equipos elevados.



**Evite ser aplastado –
Bloquee o apoye
con seguridad la
cortadora**

Antes de trabajar cerca o debajo de partes levadas de la cortadora o de los equipos:

- Apoye o bloquee con seguridad las partes elevadas de la cortadora o los equipos de acuerdo con el manual del operador.
- Apoye, bloquee o trabe con seguridad los laterales con dispositivos de bloqueo aprobados o descienda las partes de la cortadora o de los equipos hasta el suelo.
- Use trabas de transporte cuando transporte la cortadora por la vía pública.

Evite lesiones producidas por líquidos a alta presión

Evite las lesiones por inyección de fluidos debidas a fugas de líquidos a alta presión.



**El fluido a alta
presión puede
inyectarse en el
cuerpo**

Si un fluido se inyecta en la piel, debe ser extraído dentro de pocas horas por personal médico familiarizado con este tipo de lesión.

Las fugas de fluido bajo presión pueden no ser visibles. Al verificar en busca de fugas o cuando trabaja cerca de sistemas presurizados:

- Lea las prácticas de seguridad recomendadas en los manuales del operador del fabricante.
- Use una protección facial o antiparras de seguridad para proteger los ojos.
- Use un cartón o una madera para buscar fugas; **NO use las manos.**
- Alivie la presión del sistema antes de desconectar líneas.
- Busque y repare las líneas, los tubos y las mangueras dañados o con fugas.
- Busque y apriete las conexiones flojas.
- Purgue el aire del sistema antes de hacerlo funcionar.

Cumplimiento del programa de seguridad

Evite lesiones por incendios y explosiones

Aplique el freno de estacionamiento, apague el motor de la cortadora y del tractor y retire la llave mientras llena el depósito de combustible. Tenga precaución adicional cuando carga combustible en un motor caliente. Nunca fume mientras carga combustible. Evite las chispas conectando a tierra la boquilla de combustible contra el cuello de llenado del depósito.

Los vapores de un depósito de combustible vacío son explosivos. Nunca suelde o realice cortes en líneas, depósitos o contenedores de combustible.

Retire toda la basura o los residuos de corte de la máquina todos los días o según sea necesario. Mantenga los residuos alejados del motor, el escape, los embragues y otras fuentes de calor. Use supresores de chispas, según corresponda, en el sistema de escape del motor. Asegúrese de que no haya trapos con aceite u otro material inflamable almacenado en la máquina.

Revise en busca de fugas de combustible, aceite o fluido hidráulico. Repare las fugas y limpie la máquina antes de hacerla funcionar.

El éter/fluido para arranque en frío es inflamable. No fume cuando usa éter/fluido para arranque en frío. Siempre siga las instrucciones del recipiente y de los manuales del

operador del fabricante correspondientes a la cortadora de césped. No use éter/fluido para arranque en frío si el motor está equipado con bujías de precalentamiento u otro dispositivo de precalentamiento.

Siempre use solvente no inflamable para limpiar las partes. No use gasolina, combustible diesel u otros fluidos inflamables. Almacene todos los fluidos y materiales inflamables lejos de la máquina y de la zona de trabajo.

Sepa dónde se guardan los extintores de incendios, cómo funcionan y para qué tipo de incendio están destinados. Verifique la disponibilidad de los extintores de incendios de acuerdo con las instrucciones del fabricante. Asegúrese de que cada tractor esté equipado con un extintor de incendios.



**No fumar;
evitar las llamas
abiertas**

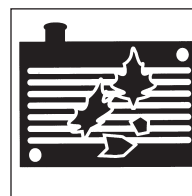

**Retire los
residuos a diario
o según sea
necesario**

Cumplimiento del programa de seguridad

¡Manténgase alerta!

Sepa dónde obtener asistencia. Sepa cómo usar un equipo de primeros auxilios y un extintor de incendios/ sistema de supresión de fuego.

¡Manténgase informado!

Aproveche los programas de capacitación que se ofrecen.

¡Tenga cuidado!

El error humano es causado por muchos factores: descuido, fatiga, sobrecarga, preocupación, desconocimiento de la máquina por parte del operador, fármacos y alcohol, entre muchos otros. Los daños al tractor o la cortadora de césped se pueden arreglar en un tiempo breve, pero las lesiones o la muerte tienen un efecto perdurable.

Por su seguridad y la de los demás, aliente a sus compañeros de trabajo a actuar con seguridad.

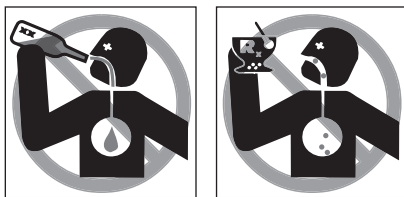

Nunca use fármacos o alcohol mientras está operando la máquina

Para una operación segura

Usted debe ser un operador cualificado y autorizado para operar la máquina correctamente. Debe comprender claramente las instrucciones por escrito que proporciona el fabricante, recibir capacitación (que incluya la operación real de la cortadora de césped) y conocer las reglas y ordenanzas de seguridad correspondientes al sitio de trabajo. Una buena práctica de seguridad consiste en señalar y explicar los letreros y las prácticas de seguridad y asegurarse de que otras personas comprendan la importancia de seguir estas instrucciones.

¡ADVERTENCIA! Los fármacos y el alcohol afectan la capacidad de alerta y de coordinación del operador, así como su capacidad para operar los equipos con seguridad. **Nunca use fármacos o alcohol mientras opera el equipo de la cortadora. Nunca permita a sabiendas que otra persona opere esta máquina con la capacidad de alerta o coordinación deteriorada.**

Un operador que toma un medicamento recetado o de venta libre debe consultar a un profesional médico con respecto a los efectos colaterales del medicamento que podrían reducir su capacidad de operar este equipo con seguridad.

Cumplimiento del programa de seguridad

Conozca las reglas

La mayoría de los empleadores tienen reglas que rigen la operación y el mantenimiento de los equipos. Antes de comenzar a trabajar en una ubicación nueva, verifique con el supervisor o con el coordinador de seguridad. Averigüe sobre las reglas que tendrá que obedecer.

La Administración de Seguridad y Salud Ocupacional (Occupational Safety and Health Administration, OSHA) hace cumplir leyes federales dentro de los EE.UU. que se aplican a la operación, la aplicación y el mantenimiento seguros de equipos en un sitio de trabajo. Es responsabilidad del empleador cumplir estas leyes. Un representante de OSHA puede visitar periódicamente un sitio de trabajo para ver si estas leyes se cumplen.

También puede haber leyes estatales/provinciales o locales u ordenanzas internacionales que se apliquen a este equipo y a su uso, junto con reglas específicas del sitio de trabajo o del empleador. Es importante que conozca y cumpla todas las leyes y reglas aplicables, incluso las que requieren capacitación y certificación del operador.

Las siguientes son algunas de las reglas que debe cumplir al trabajar:

- Un ROPS (sistema de protección antivuelco) y un tractor equipado con cinturón de seguridad es exigencia del

gobierno federal (OSHA) para la protección de los operadores durante el funcionamiento de la cortadora. Una cabina cerrada proporciona protección adicional para el operador con respecto a objetos arrojados. Verifique el manual del operador de la cortadora de césped para ver si también se requiere una cabina de tractor.

- Use y verifique que otras personas usen la indumentaria y los equipos de protección personal correctos.
- Inspeccione la máquina y los accesorios antes de cada uso según lo especificado por el fabricante y por su empleador.
- Conozca las limitaciones y las características operativas del equipo de corte de césped. No haga un uso indebido.
- Verifique que todos los escudos y las guardas estén correctamente instalados antes de hacer funcionar la máquina.
- Nunca modifique o retire partes de la máquina (excepto para realizar servicios; después, asegúrese de que se vuelvan a colocar en su lugar).

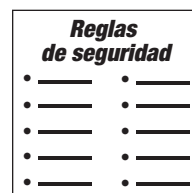

Sepa cuáles son y asegúrese de comprender las reglas de funcionamiento

Cumplimiento del programa de seguridad

Algunas reglas que debe cumplir al trabajar (continuación)

- Únicamente personas cualificadas y autorizadas pueden manejar estos equipos.
- **Nunca permita que los niños jueguen** en los equipos, **viajen** en ellos o los hagan **funcionar**. Los niños **no están** cualificados para manejar estos equipos.
- **No** transporte pasajeros.
- Use contacto en tres puntos (asideros y peldaños) y enfrente el equipo al ascender o descender de él.
- Mantenga a las personas ajenas a 300 pies (92 m) de la operación de corte.
- Familiarícese con el sitio de trabajo antes de usar la cortadora de césped. Tenga en cuenta posibles riesgos que puede encontrar en el terreno. Retire o marque los obstáculos y residuos que podrían dañar la cortadora o ser arrojados por ella.
- Utilice sólo accesorios y partes aprobados por el fabricante de la cortadora de césped.
- Asegúrese de que todos accesorios estén descendidos, aplique el freno de estacionamiento, apague el motor y haga funcionar todas las palancas de control. Retire la llave antes de salir del tractor. (Consulte la página 18, **Prácticas correctas de apagado de los equipos.**)
- Cuando transporte la cortadora de césped en un remolque, siga las instrucciones detalladas del fabricante para la carga, el amarre y la descarga de la cortadora.

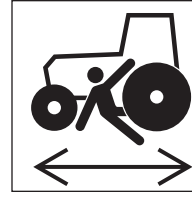

Mantenga a los niños alejados de los equipos



Mantenga a las personas ajenas alejadas



No lleve pasajeros

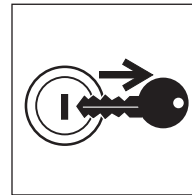

Apague los equipos cuando están sin vigilancia

Cumplimiento del programa de seguridad

Conozca los equipos

Lea y asegúrese de comprender los letreros de seguridad que indican PELIGRO, ADVERTENCIA, PRECAUCIÓN y AVISO y otros letreros informativos que hay sobre el tractor y la cortadora de césped y en el manual del operador del fabricante. Solicítele al supervisor o al distribuidor de la cortadora que le explique cualquier información que no comprenda. El incumplimiento de las instrucciones de seguridad podría resultar en lesiones graves o muerte.

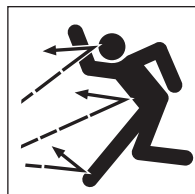

Lea y asegúrese de comprender todos los letreros de seguridad

Asegúrese de que todas las estructuras de protección, guardas, escudos, pantallas y paneles del fabricante están bien reparados, en su lugar y bien ajustados. Los componentes de seguridad dañados, faltantes o debilitados pueden crear una situación de riesgo para usted como operador. **Nunca** retire o modifique ningún componente de seguridad (incluso escudos para objetos arrojados) que haya en la cortadora.

Conozca lo siguiente sobre el tractor y la cortadora de césped:

- Funcionamiento, propósito y uso de todos los controles.
- Velocidades de funcionamiento correctas.
- Capacidades y funcionamiento correcto en pendientes y terrenos desparejos.
- Características del frenado y la dirección.
- Radio de giro y separaciones.
- Cómo detener los equipos rápidamente en una emergencia.

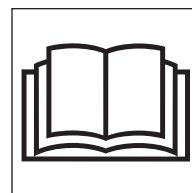

Lea y asegúrese de comprender los manuales antes de comenzar la operación

Preparación para una operación segura

Revise los equipos de la cortadora de césped y el tractor

Antes de comenzar la jornada de trabajo, inspeccione la máquina y asegúrese de que todos los sistemas estén en buenas condiciones operacionales.

¡ADVERTENCIA! Evite posibles lesiones por aplastamiento producidas por equipos que caen. La falla del sistema hidráulico o de una parte podría causar la caída de equipos que no están apoyados. **No permanezca debajo de equipos elevados excepto que estén correctamente apoyados de acuerdo con el manual del operador.**

- Realice procedimientos de servicio diarios y periódicos según lo indicado por el fabricante del equipo.
- Verifique para detectar piezas faltantes, dañadas, rotas o flojas en el tractor y en la cortadora de césped. Repare o sustituya esas piezas.
- Verifique que los accesorios del tractor y la cortadora sean los correctos.
- Verifique que la clasificación nominal de velocidad de TDF del tractor y la cortadora sea la correcta.
- Verifique el estado de las hojas de la cortadora de césped. Sustituya las hojas que se encuentren gravemente gastadas, dobladas, agujereadas o

marcadas; incluya los pernos y sujetadores de las hojas. Nunca enderece o suelde en las hojas.

- Asegúrese de que el escudo para objetos que son arrojados se encuentre correctamente instalado y en buen estado. Repárelo o sustitúyalo si está dañado o falta.

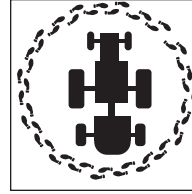

Recorrida de inspección

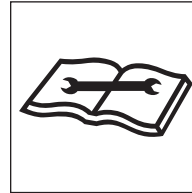

Realice el mantenimiento de la máquina

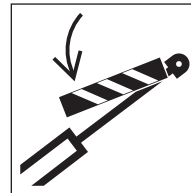

Lea el manual – Bloquee o apoye con seguridad la cortadora

Preparación para una operación segura

- Verifique que todos los escudos y guardas estén en su lugar y que todos los equipos se encuentren en buenas condiciones de funcionamiento. Esto incluye la línea motriz de la TDF, la caja de engranajes y las guardas y escudos de los implementos que se usan para proteger al operador.
- Verifique que los dispositivos de bloqueo del extremo en horquilla de la línea motriz estén correctamente enclavados.
- Verifique en busca de sistemas hidráulicos dañados o con fugas en el tractor o la cortadora. Repare o ajuste según sea necesario.

¡ADVERTENCIA! El fluido hidráulico bajo presión puede penetrar la piel o los ojos y causar lesiones graves, ceguera o la muerte. Las fugas de fluido bajo presión pueden no ser visibles. **Utilice un cartón o una madera para buscar fugas, no la mano. Use protección ocular.** Si el fluido se inyecta en la piel, debe ser extraído dentro de las próximas pocas horas por personal médico familiarizado con este tipo de lesión.

- Mantenga la superficie de la plataforma del operador limpia y libre de grasa, aceite, suciedad, nieve o hielo. Los peldaños y asideros deben estar limpios y funcionar correctamente.
- Asegúrese de que las luces de trabajo se mantengan limpias (si están instaladas). Verifique que todas las luces funcionen correctamente.

- Asegúrese de que el letrero de vehículo de movimiento lento, los y las luces de advertencia estén en buenas condiciones y puedan verse claramente.
- Asegúrese de que todas las herramientas y objetos sueltos se retiren o se sujeten con seguridad mientras se opera la máquina.
- Verifique que todos los letreros de seguridad se vean con claridad. Sustituya los letreros dañados.



Revise para detectar/guardas y escudos dañados



Verifique en busca de fugas e inspeccione las mangueras



Aparte las reflectores herramientas

Preparación para una operación segura

Familiarícese con la zona de trabajo

Antes de hacer funcionar la cortadora de césped, inspeccione cuidadosamente la zona de trabajo. Recorra a pie alrededor de la zona e inspeccione las superficies sobre las cuales se desplazará cuando utilice la cortadora.

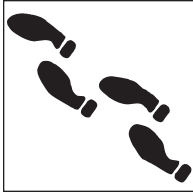

Recorra a pie
alrededor del lugar
de trabajo

Localice y evite:

- Agujeros
- Desmoronamientos
- Obstáculos (tocones)
- Excavaciones
- Agua estancada
- Lodo profundo
- Puntos mojados
- Suelo blando
- Puntos irregulares
- Líneas y aparatos eléctricos
- Otros servicios públicos
- Cualquier condición que podría causar una colisión, pérdida de control o vuelco
- Pendientes empinadas

Busque residuos y obstáculos recorriendo a pie la zona antes de cortar. Los objetos como alambre, cable, rocas, neumáticos y metales que podrían dañar o ser arrojados por la cortadora de césped deben retirarse o marcarse claramente y evitarse.

Corrija las condiciones no seguras. No opere en áreas con problemas donde no se puedan retirar o marcar los residuos y los obstáculos.

Analice la zona de corte para determinar:

- El procedimiento de corte más eficiente.
- La altura del material que debe cortarse.
- Las condiciones operativas del terreno.
- Cómo usar mejor el patrón de corte en sentido de avance.
- Las posibilidades de que personas ajenas o que pasan circunstancialmente queden expuestas a objetos que se arrojan.

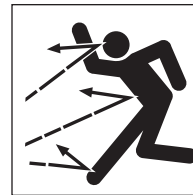

Retire o marque
los residuos y
obstáculos

Tenga cuidado con otras personas

Antes de poner en marcha los equipos:

- Recorra a pie alrededor de los equipos.
- Verifique en busca de personas debajo o cerca de los equipos.
- Retire a todas las personas de esas zonas.
- Haga sonar una advertencia.

Preparación para una operación segura

Ascienda y descienda del tractor correctamente

Siempre use contacto de tres puntos al ascender o descender del tractor o de la cortadora de césped. Enfrente la máquina al ingresar o salir de ella. Un contacto de tres puntos significa que tres de los cuatro miembros (brazos y piernas) están en contacto con la máquina en todo momento durante el ascenso y descenso.

Antes de ascender:

- Límpiense el calzado y las manos. Limpie la nieve, el hielo, el lodo o el aceite de los peldaños y asideros.

Durante el ascenso y el descenso:

- Use los asideros y los estribos.
- Nunca se aferre al volante o a los controles como asideros.
- Nunca ascienda o descienda de un tractor en movimiento.
- Nunca ascienda o descienda transportando herramientas u objetos que impidan el contacto de tres puntos. Deje en el piso las piezas o las herramientas. Manteniendo el contacto correcto, suba y, después, recoja el objeto.



Utilice contacto
de tres puntos



Limpie las
superficies
resbaladizas

Preparación para una operación segura

Prueba de seguridad de los controles del tractor y de la cortadora de césped

Arranque el tractor siguiendo los procedimientos específicos del manual del operador del fabricante. Estos procedimientos normalmente incluyen:

- Colóquese y ajústese el cinturón de seguridad en el tractor equipado con ROPS.
- Verifique que el freno de estacionamiento esté aplicado.
- Verifique que la TDF esté desenganchada.
- Verifique que todos los controles estén en la posición de estacionamiento.
- Advierta a otras personas en la zona antes de arrancar el tractor.
- Arranque el tractor siguiendo los procedimientos de arranque que recomienda el fabricante del tractor.

¡ADVERTENCIA! Evite lesiones graves o muertes producidas por el movimiento inesperado de la máquina. **Arranque el motor únicamente desde el puesto del operador. Nunca intente arrancar el motor haciendo un corto entre los bornes del arranque o tomando la llave desde el suelo o desde afuera de la cabina.**

Después del arranque:

- Verifique que todos los instrumentos, indicadores y luces indicadoras funcionen normalmente.
- Verifique que todos los controles, la dirección y los frenos del tractor funcionen correctamente.

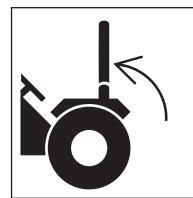

Use el ROPS y el cinturón de seguridad



Arranque únicamente desde el asiento del operador

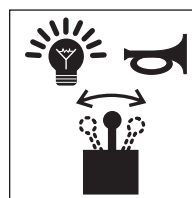

Revise los instrumentos y controles

- Eleve y descienda la cortadora de césped en busca de problemas en el descenso total o el enganche de la línea motriz.
- Verifique los equipos en busca de vibraciones excesivas y ruidos anormales.

Preparación para una operación segura

- Use las prácticas correctas de apagado de los equipos antes de inspeccionar equipos. Espere hasta que todo movimiento de los equipos se haya detenido antes de descender del tractor o la cortadora de césped.
- No haga funcionar la cortadora si el tractor y la cortadora de césped no funcionan correctamente. Coloque una etiqueta que indique “No poner en funcionamiento” en la máquina, retire la llave y no haga funcionar la cortadora hasta que el problema se haya corregido.

Sistema de toma de fuerza (TDF)

Asegúrese de hacer funcionar el tractor a la velocidad de TDF indicada para la cortadora.

Al hacer funcionar tractores con sistemas de TDF impulsados por transmisión, una cortadora giratoria tiene un significativo efecto de rueda volante. La cortadora puede seguir propulsando un tractor con un sistema de TDF impulsado por transmisión.

El tractor debe estar equipado y funcionar como sigue:

- Instale una línea motriz equipada con un embrague de sobrecarga.
- Prevea suficiente espacio y tiempo para maniobrar anticipando los giros, las paradas y las reducciones de velocidad.



No descienda hasta que el movimiento de los equipos se haya detenido



Use una etiqueta que indique “No poner en funcionamiento”

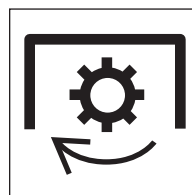

Use la velocidad de la TDF

Preparación para una operación segura

Enganche de la cortadora de césped al tractor

Cortadoras montadas en enganche de tres puntos:

- Consulte los manuales de los fabricantes de la cortadora y del tractor.
- Coloque la palanca selectora de elevación de potencia hidráulica del tractor en la posición descendida para evitar movimientos imprevistos.
- Explique los procedimientos de enganche a los operadores que no puedan leerlos.
- Pueden requerirse pesos en el extremo delantero para mantener el control de la dirección y la estabilidad del extremo delantero. Consulte los manuales del operador de los fabricantes.
- Al hacer retroceder el tractor hasta la cortadora de césped, NUNCA permita que haya personas entre tractor y la cortadora.
- Instale la cortadora en los eslabones de tres puntos del tractor y asegúrela en su lugar con pasadores.
- Instale con seguridad la línea motriz a la TDF del tractor. Descienda el escudo principal hasta su lugar si es móvil. Empuje y tire de la línea motriz para asegurarse de que esté trabada en el vástago de la TDF.

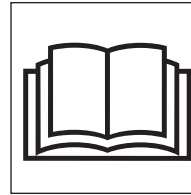

Lea y asegúrese de comprender los manuales antes de comenzar la operación



Mantenga una distribución correcta del peso



No permita que haya nadie entre el tractor y la cortadora de césped



Evite quedar enredado, use guardas y escudos

Preparación para una operación segura

Cortadoras montadas en enganche tipo de tiro:

- Consulte los manuales de los fabricantes de la cortadora y del tractor.
- Retire el acople rápido del enganche de tres puntos si está instalado.
- Instálelo únicamente al enganche de la barra de tiro.
- Ajuste la longitud de la barra de tiro del tractor para el funcionamiento de la TDF a 540 ó 1000 rpm.
- Al hacer retroceder el tractor hasta la cortadora de césped, NUNCA permita que haya personas entre tractor y la cortadora.
- Instale correctamente la cadena de remolque de seguridad de la cortadora en el tractor.
- Instale con seguridad la línea motriz a la TDF del tractor. Empuje y tire de la línea motriz para asegurarse de que esté trabada en la TDF. Descienda el escudo principal a su lugar.
- Conecte las mangueras hidráulicas de la cortadora de césped en el tractor.
- Asegúrese de que los laterales o las plataformas elevadas de la cortadora estén sostenidas por los cilindros antes de retirar las trabas de transporte. Nunca haga fuerza para soltar las trabas de transporte o de los laterales. Los laterales o la plataforma podrían caerse y aplastarlo.

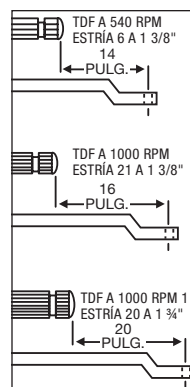

Ajuste de la barra de tiro del tractor



Confirme que los laterales estén apoyados antes de soltar las trabas



Evite quedar enredado, use guardas y escudos

Arranque con seguridad

Cómo realizar un arranque correcto

Corte la hierba únicamente con luz diurna o en condiciones de buena luz artificial.

Evite lesiones graves o muerte producidas por objetos arrojados por la cortadora o por el contacto con las hojas:

- Mantenga los escudos de las cadenas, los escudos deflectores flexibles o sólidos y las rampas de descarga en su lugar y en buen estado de reparación.
- Mantenga a las personas ajenas a 300 pies (92 m) de la operación de corte.
- Nunca dirija la descarga de la cortadora hacia una persona.
- Mantenga las manos, los pies y otras partes del cuerpo alejadas de las piezas giratorias, las hojas y las aberturas de descarga.
- No haga funcionar la cortadora de césped en la posición de transporte.

No se acerque a una cortadora hasta que todo movimiento se haya detenido.

Enganche de la transmisión de RDF de la cortadora de césped:

- Eleve la cortadora hasta la altura de corte máxima.
- Enganche la TDF a baja velocidad del motor.
- Aumente la velocidad del motor hasta llegar a la velocidad nominal de la TDF.
- Descienda la cortadora hasta la altura de corte deseada.
- Detenga y apague de inmediato si la cortadora golpea contra una obstrucción.
- Inspeccione y repare cualquier daño de la cortadora antes de reanudar el corte.
- No haga funcionar una cortadora que vibra en exceso o produce ruidos anormales.

Operación con seguridad

Los escudos de la cortadora están diseñados para reducir el riesgo de objetos arrojados y se deben mantener correctamente y en su lugar durante las operaciones de corte.

El riesgo de lesiones graves o muerte puede reducirse significativamente si se siguen estas reglas. **Si no se siguen todas estas reglas de seguridad, la operación de corte debe detenerse en caso de que alguna persona ingrese dentro del límite de seguridad correspondiente a cada tipo de cortadora.**

Primero — Inspeccione la zona antes de cortar y retire las piedras, ramas, alambres, cables, metales, vidrios y otros objetos sólidos antes de hacer funcionar la máquina. Los objetos que no puedan retirarse deben marcarse con claridad y ser evitados con cuidado por el operador.

En áreas sin cultivos con hierba y maleza de altura suficiente como para ocultar objetos que podrían ser golpeados por las hojas, inspeccione la zona y retire o marque los residuos u obstáculos grandes.



Hojas giratorias – Manténgase



No ponga en funcionamiento una cortadora de césped dañada

Objetos arrojados por la cortadora de césped

Dependiendo del propósito previsto, las cortadoras están diseñadas para cortar hierba, maleza, broza y cultivos. Las hojas de la cortadora están diseñadas y probadas para uso intensivo. Las hojas de la cortadora, sin embargo, no están diseñadas para entrar en contacto con objetos sólidos como rocas, cemento o metales. Un impacto de este tipo puede arrojar objetos rotos hasta 300 pies (92 m) de distancia. Nunca debe haber personas ajenas a menos de 300 pies (92 m) de una cortadora giratoria en funcionamiento o a menos de 100 pies (30 m) de una cortadora de disco correctamente equipada.



Siga todas las reglas de seguridad

Realice el corte de la zona a una altura intermedia. Inspeccione la zona atentamente y retire o marque cualquier residuo u obstáculo restante. Corte nuevamente a la altura final deseada.

Segundo — Los escudos para objetos arrojados por la cortadora deben usarse cuando se opera cerca de caminos, parques, zonas pobladas u otras zonas donde objetos arrojados podrían lesionar a personas ajenas o dañar la propiedad. Siga el manual del operador del fabricante.

Tercero — Cruce en sentido diagonal cuando realiza el corte a través de zanjas, depresiones marcadas y hundimientos. Eleve la cortadora para evitar que las hojas de la cortadora golpeen el suelo.

Operación con seguridad

Objetos arrojados por la cortadora de césped (continuación)

Cortadoras de disco — Cuando se usa una cortadora de disco, es importante conocer la zona donde se va a cortar. Si el operador ha realizado cortes en el terreno antes y está familiarizado con todos los obstáculos que puede haber, es suficiente observar delante de la trayectoria de la cortadora para detectar cualquier objeto adicional que pueda haber ingresado en el terreno. Está preparado para detenerse o evitar objetos que podrían ser peligrosos si son arrojados por la cortadora. Si piensa cortar en un terreno que no conoce bien y se encuentra junto a un camino transitado o puede haber personas a menos de 100 pies (30 m) de la cortadora de césped, debe inspeccionar y limpiar o marcar el terreno.

Cómo cortar en retroceso

No corte mientras se desplaza en retroceso. Es más probable que se arrojen objetos y que éstos puedan llegar más lejos.



Apague la TDF, espere que las hojas dejen de girar, eleve la cortadora y, después, retroceda.

Corte desplazándose en sentido de avance.

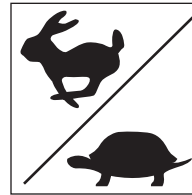

Velocidad de desplazamiento durante el corte

La velocidad de desplazamiento correcta depende de las condiciones del terreno y del tipo de hierba, la densidad y la altura que debe cortarse:

- El rango normal de velocidad de desplazamiento es de 2 a 5 mph (3.2 a 8 km/h).
- Use una velocidad de desplazamiento menor para cortar hierbas altas y densas.
- Use una velocidad de desplazamiento mayor para cortar hierba delgada a altura media y con condiciones de terreno sin dificultades.
- Use una velocidad de desplazamiento menor para acortar en terreno irregular, con pendientes o no muy conocido.

Las cortadoras de disco están diseñadas para usar velocidades de desplazamiento mayores cuando funcionan en terrenos despejados de residuos y peligros superficiales.

Operación con seguridad

Corte de hierba extremadamente alta

Puede ser necesario cortar dos veces la hierba extremadamente alta que no sea cultivo. (Consulte la página 13, **Objetos arrojados por la cortadora de césped.**)

Primera pasada de corte:

- Apague la cortadora y el tractor usando la práctica correcta de apagado de equipos antes de descender del tractor. (Consulte la página 18, **Prácticas correctas de apagado de los equipos.**)
- Inspeccione la zona y retire o marque cualquier residuo u obstáculo.
- Corte la hierba a mayor altura (10 a 15 pulg. [25 a 38 cm]) para evitar los objetos ocultos.

Segunda pasada de corte:

- Apague la cortadora y el tractor usando la práctica correcta de apagado de equipos antes de descender del tractor.
- Inspeccione la zona y retire o marque cualquier residuo u obstáculo.
- Corte la hierba a la altura deseada y, de ser posible, a 90 grados con respecto a la primera pasada de corte.

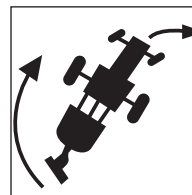
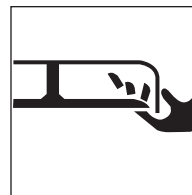

Preste atención a los espacios libres de los equipos

Las cortadoras con enganche de tres puntos y montaje lateral tienen un arco de giro mayor que las tipo de tiro. Deje el espacio libre suficiente para la oscilación de la cortadora cuando gira.

No permita que haya personas ajenas cerca del tractor y la cortadora de césped cuando mueve o transporta el tractor y la cortadora.

Operación con seguridad

Prácticas de seguridad para la cortadora de césped de montaje inferior

Cuando se traslada con una cortadora de césped de montaje inferior:

- Mantenga la rampa de descarga extraíble en su lugar y por encima de la abertura de descarga.
- Nunca se pare sobre la carcasa de una cortadora de césped cuando el motor del tractor está en funcionamiento.
- Distribuya los recortes de hierba con la rampa de descarga orientada hacia la zona donde se cortó.
- Antes de limpiar una cortadora o una rampa de descarga atascada, apague la máquina usando la práctica correcta para apagado del equipo. (Consulte la página 18, **Prácticas correctas de apagado de los equipos.**)



Nunca se pare sobre la cortadora de césped – Manténgase alejado

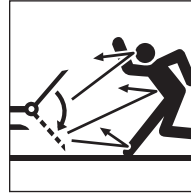

Mantenga la rampa en su lugar

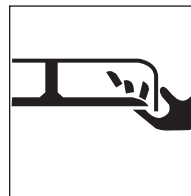

Detenga la hoja antes de desatascar

Operación con seguridad

Cortadora de césped con lateral o aguilón Peligros y riesgos de obstrucciones elevadas

Verifique en busca de obstrucciones elevadas con las cortadoras que tienen el lateral o el aguilón elevado, para evitar lesiones graves o la muerte por contacto con:

- Líneas y aparatos eléctricos.
- Ramas bajas de los árboles.
- Otras obstrucciones elevadas.
- Mantenga las distancias especificadas con respecto a los cables y los aparatos eléctricos. Nunca se acerque a cables o aparatos eléctricos energizados con ninguna parte de la máquina, salvo que se hayan tomado todas las precauciones de seguridad locales, estatales/provinciales y federales (OSHA) necesarias. Use extrema precaución.

¡PELIGRO! Evite la electrocución o lesiones graves por contacto o un espacio libre inadecuado con respecto a líneas o aparatos eléctricos energizados. **No permita que la máquina o el accesorio se acerque o entre en contacto con una línea de electricidad. No se acerque ni toque una máquina que esté en contacto con una línea de electricidad.**

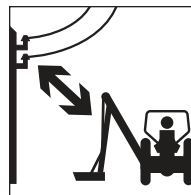

No se acerque a líneas de electricidad energizadas

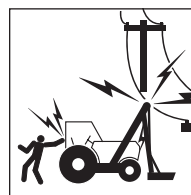

Manténgase alejado de los equipos energizados

Operación con seguridad

Prácticas de seguridad para cortadoras de césped con laterales y montaje lateral

Las posiciones elevadas de los laterales reducen la protección de los escudos y aumentan los riesgos de objetos arrojados y contacto con las hojas.

Evite la posibilidad de lesiones graves o muerte por objetos arrojados o contacto con las hojas causados por la elevación y el descenso de los laterales durante las operaciones de corte:

- No realice cortes con personas ajenas presentes a menos de 300 pies (92 m) de la cortadora de césped.
- Asegúrese de que no haya personas cerca de la cortadora mientras se elevan o descienden los laterales.
- Apague la TDF y espere hasta que todos los elementos giratorios se hayan detenido antes de elevar la plataforma o la sección lateral de la cortadora.
- Únicamente eleve el lateral para quitar objetos de la trayectoria de corte o para acompañar una pendiente del terreno.
- Descienda hasta el suelo el lateral elevado una vez que se eliminó el objeto o se superó la pendiente.
- Detenga el trabajo de corte si alguna persona se acerca a menos de 300 pies (92 m) de la zona de corte.

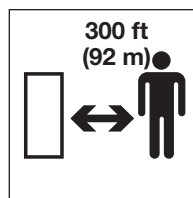

Mantenga a las personas ajenas alejadas de la zona de corte

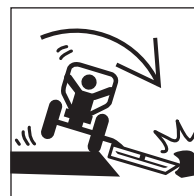

Evite golpear obstrucciones

Prácticas de seguridad para trabajos de corte en orillas de zanjas

Use extremo cuidado al realizar cortes en orillas de zanjas. Preste atención a escurrimientos, zonas erosionadas y obstrucciones para el corte a lo largo de las orillas de zanjas. Si se golpean obstrucciones con cortadoras de montaje lateral o con aguilón, el extremo delantero del tractor puede desviarse hacia la zanja.

Operación con seguridad

Los trabajos en orillas de zanjas con aguilón y lateral elevado pueden reducir la eficacia de la protección del operador de la cortadora que proporcionan los escudos para objetos arrojados.

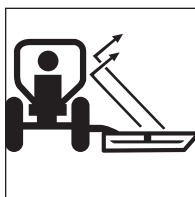

Utilice cabinas cerradas con ROPS o cerramientos de protección

- Cuando realice estas operaciones, use cabinas cerradas con ROPS, cerramientos protectores especiales y otros escudos para el operador que ofrece el fabricante.
- Inspeccione la zona de corte y retire o marque todos los objetos extraños y los residuos que deberá esquivar la cortadora.

Prácticas de seguridad para trabajos de corte en terrenos desparejos

Las pendientes y los terrenos desparejos reducen la estabilidad del tractor y de la cortadora.

Como en todas las condiciones de corte, use tractores equipados con ROPS y cinturón de seguridad. **Asegúrese**

de que el ROPS está elevado y trabado en su lugar y use siempre el cinturón de seguridad.

Prevenga los vuelcos del tractor y de la cortadora de césped y mantenga controlada la estabilidad de los equipos:

- Repase los manuales del operador del tractor y de la cortadora para ver las prácticas de seguridad para operaciones en pendientes y terrenos desparejos. Explique las prácticas a los operadores que no puedan leerlas.
- Evite trabajar en pendientes extremadamente empinadas.

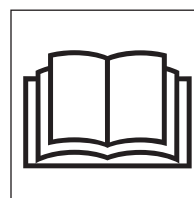

Lea y asegúrese de comprender los manuales antes de comenzar la operación

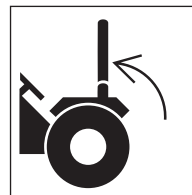
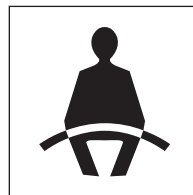

Use el ROPS y el cinturón de seguridad

Operación con seguridad

Prácticas de seguridad para trabajos de corte en terrenos desparejos (continuación)

- Use extremo cuidado para mantener el control de los equipos cuando trabaja en estas condiciones.
- Aumente la estabilidad del tractor agregando pesos o lastre en las ruedas y aumentando al máximo la separación entre las ruedas. Consulte las recomendaciones en el manual del operador.
- Mantenga la velocidad de desplazamiento en el mínimo.
- Realice giros amplios y graduales.
- Evite los arranques, las paradas y los giros bruscos cuando trabaje en subidas o bajadas de pendientes o sobre ellas.
- **No** levante del suelo las cortadoras de montaje trasero o de montaje lateral ni los laterales de la cortadora durante estas operaciones.
- Manténganse alerta en busca de agujeros, baches, pozos, tocones u otras obstrucciones que podrían hacer volcar la máquina.
- Evite las condiciones de suelo resbaladizo que podrían causar la pérdida de control y el vuelco del tractor y la cortadora.
- Evite bajar completamente y golpear el suelo cuando cruza en sentido diagonal depresiones marcadas y hundimientos.

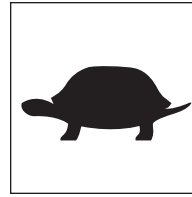

Mantenga el control, desplácese



Agregue lastre, ensanche la separación entre las ruedas



Evite los pozos, baches y agujeros

Use extremo cuidado al mantener la estabilidad de los equipos durante todos los trabajos de corte en terrenos desparejos y pendientes. Usted es quien juzga en última instancia si en cualquier pendiente se puede trabajar con seguridad.

Operación con seguridad

Prácticas de seguridad para el transporte en caminos

Antes de operar en la vía pública:

- Consulte los manuales del operador de los fabricantes de la cortadora y del tractor para ver instrucciones.
- Explique las instrucciones a los usuarios u operadores que no puedan leerlas.
- Verifique las ordenanzas locales sobre marcas, luces, balizas, etc. requeridas en los equipos durante el desplazamiento por la vía pública. Se requieren luces en las cortadoras que obstaculizan la visibilidad de las luces traseras y/o las luces de advertencia del tractor.
- Cuando transporte la cortadora de césped en un remolque, siga las instrucciones detalladas del fabricante para la carga, el amarre y la descarga de la cortadora.

Antes de transportar en la vía pública:

- Desconecte la alimentación de la TDF a la cortadora.
- Eleve la cortadora a la posición de transporte y aplique la traba para transporte.
- Trabe los laterales de la cortadora de césped en la posición de transporte con dispositivos de bloqueo aprobados.
- Instale una cadena de seguridad para remolque entre la cortadora tipo de tiro y el tractor.
- Asegúrese de que las luces, las luces de advertencia y los reflectores están en su lugar y son visibles.

- Verifique que el emblema de vehículo de movimiento le resulte visible a cualquier vehículo que se aproxime por atrás.

Durante el transporte en la vía pública:

- Obedezca todas las ordenanzas de tránsito locales.
- Acérquese a las intersecciones con precaución.
- Observe los letreros de velocidad y control del tránsito.
- Evite las paradas de emergencia y los giros cerrados.

Sea un operador amable y apártese periódicamente para dejar pasar el tránsito.

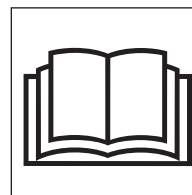

Lea y asegúrese de comprender los manuales antes de comenzar la operación



Obedezca las ordenanzas de tránsito

Estacionamiento seguro

Prácticas de seguridad para el estacionamiento

- Use las zonas designadas o alejadas del tránsito.
- Use lugares con suelo firme y nivelado.
- Aplique el freno de estacionamiento.
- Descienda el equipo de la cortadora de césped hasta el suelo.

Apague la cortadora y el tractor usando la práctica correcta de apagado de equipos antes de descender del tractor. (Consulte la página 18, **Prácticas correctas de apagado de los equipos.**)

Lugares de estacionamiento con suelo en pendiente:

- Ubique los equipos transversalmente con respecto a la pendiente.
- Aplique los frenos de estacionamiento.
- Descienda el equipo de la cortadora de césped hasta el suelo.
- Bloquee las ruedas del tractor.



Aplique el freno de estacionamiento

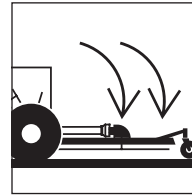

Descienda los equipos elevados hasta el suelo

Antes de estacionar temporalmente y dejar equipos

deshabilitados cerca de zonas con tránsito:

- Retire los equipos de la vía pública.
- Instale banderas de advertencia.
- Use las balizas de advertencia del tractor.

Apagado con seguridad

Prácticas correctas de apagado de los equipos

Transforme el apagado correcto de los equipos en un hábito.

El apagado correcto de un tractor y una cortadora de césped puede ayudar a evitar accidentes cuando la cortadora está sin vigilancia. Apague la cortadora siguiendo los procedimientos específicos del manual del operador del fabricante. Estos procedimientos normalmente incluirán:

- Reduzca la velocidad del motor.
- Desenganche el embrague de la TDF y la transmisión.
- Haga funcionar el motor en ralentí para que se enfríe gradualmente.
- Coloque todos los controles en la posición de estacionamiento.
- Aplique el freno de estacionamiento.
- Descienda la cortadora de césped hasta el suelo.
- Descienda los laterales de las cortadoras con laterales hasta el suelo.
- Apague el motor, trabe la ignición y retire la llave de la máquina; llévela con usted.
- Espere hasta que todas las piezas móviles se hayan detenido antes de descender.
- Libere la presión hidráulica moviendo los controles hidráulicos varias veces en todas las direcciones.
- Trabe las cubiertas y los cerramientos antivandalismo, si están instalados, cuando los equipos están sin vigilancia.
- Descienda con cuidado manteniendo contacto de tres puntos.

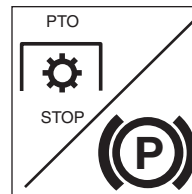

Desenganche la TDF, aplique el freno

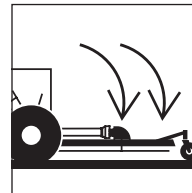

Descienda los equipos elevados hasta el suelo



Espere hasta que las piezas giratorias se detengan

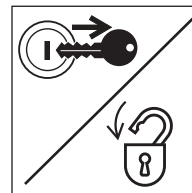

Retire la llave, trabe la ignición, llévese la llave

Apagado con seguridad

Descenso correcto

- Nunca descienda de equipos en movimiento.
- Nunca baje de una máquina saltando.
- Descienda con cuidado.
- Verifique que no haya peldaños resbaladizos.
- Mantenga los pies y las manos lejos de los controles.
- Use los asideros y los peldaños durante el descenso.
- Enfrente la máquina y use contacto de tres puntos (2 manos y 1 pie o 2 pies y 1 mano).



Espere hasta que las piezas móviles se detengan



Use contacto de tres puntos; enfrente a la máquina

Realización de mantenimiento con seguridad

Mantenimiento de los equipos

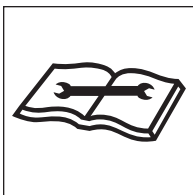

Realice el mantenimiento de los equipos

Asegúrese de mantener los equipos de acuerdo con las instrucciones del fabricante. Verifique con regularidad el funcionamiento de los dispositivos de protección y de seguridad.

No realice ningún trabajo en un tractor o en una cortadora de césped si no está autorizado y cualificado para hacerlo.

Si ha sido autorizado para realizar mantenimiento, **lea los manuales del operador y de servicios**. Estudie las instrucciones; verifique las tablas de lubricación; examine todos los mensajes de instrucciones que haya sobre la máquina. El mantenimiento puede ser peligroso si no se realiza correctamente. Asegúrese de tener las habilidades necesarias, la información y las herramientas y equipos correctos para realizar el trabajo.

¡ADVERTENCIA! No modifique equipos ni agregue componentes no aprobados por el fabricante. Use piezas, lubricantes y técnicas de servicio recomendadas por el fabricante.

Piezas de la cortadora de césped y seguridad personal

Los fabricantes de cortadoras de césped usan sujetadores y específicos y piezas especialmente diseñadas para cumplir con los requisitos de las operaciones de las cortadoras. Las piezas críticas (pernos autobloqueantes de las hojas, hojas, pasadores, escudos y otros componentes especiales) tienen requisitos específicos de resistencia, diseño y ajuste para la marca y el modelo de cortadora que usted está usando.

Evite posibles lesiones graves o la muerte por el uso de piezas o modificaciones no aprobadas:

- No sustituya con tornillería común los pernos de las hojas u otros componentes de piezas especiales originales del fabricante.
- No sustituya hojas, pasadores, escudos u otras piezas críticas.
- No use pernos de mayor resistencia para reemplazar los pernos de seguridad originales del fabricante.

Realización de mantenimiento con seguridad

Preparación personal

Use la ropa de protección personal y los equipos de protección personal (PPE) que se le proporcionen o que requieran las condiciones del trabajo. **SIEMPRE** debe usar gafas de seguridad con escudos laterales.

Puede necesitar también:

- Casco
- Calzado de seguridad
- Anteojos de seguridad, antiparras o protección facial
- Delantal y guantes
- Protección para oídos
- Casco o antiparras para soldar
- Respirador o máscara con filtro

Use la ropa necesaria; no corra ningún riesgo.

Mantenga las manos (y la ropa) alejadas de todas las piezas móviles. No use cordones sueltos, mangas flojas, anillos, relojes o cabello largo.

¡ADVERTENCIA! Evite lesiones graves o muerte por enredos. **No use ropa floja ni accesorios. Manténgase alejado de todos los componentes giratorios cuando el motor está en funcionamiento.** El contacto, el enrollado o el enredo con piezas giratorias o móviles podrían resultar en lesiones graves o la muerte.



Evite las piezas giratorias



Evite puntos donde pueda quedar atrapado

Realización de mantenimiento con seguridad

Use un delantal de caucho y guantes de caucho cuando trabaja con sustancias corrosivas. Use guantes y calzado de seguridad cuando manipula bloques de madera o metales con bordes agudos.

Use siempre anteojos de seguridad, antiparras o protección facial. Proporcionan protección ocular para fluidos bajo presión, mientras se esmerila y se realizan servicios a las baterías. También es necesaria protección contra residuos, líquidos y material suelto producido por el equipo, las herramientas y el aire/agua presurizada.

Use protección facial y siga las instrucciones del fabricante cuando desarma componentes cargados a resorte o cuando trabaja con ácidos de batería. Use un casco o antiparras para soldar con filtro esfumado cuando suelda o corta con soplete.

No arene, esmerile, corte con soplete o suelde sin un respirador aprobado por NIOSH o una ventilación adecuada. Si se requiere soldar en esta máquina, consulte los manuales del operador o de servicios del fabricante o consulte al concesionario de los equipos para obtener los procedimientos correctos.

Mantenga los bolsillos sin objetos que podrían salirse y caer dentro de la maquinaria.



Limpie las superficies resbaladizas



Ventile la zona de trabajo

Maneje las herramientas y las piezas pesadas con sensatez con respecto a usted mismo y a otras personas. Deposite los elementos, no los deje caer.

Preparación de la zona de trabajo

- Ubique la cortadora de césped en una zona nivelada fuera del paso de otros equipos en funcionamiento.
- Asegúrese de que haya luz, ventilación y espacio libre adecuados.
- Quite el aceite, la grasa o el agua para eliminar toda superficie resbaladiza.
- Limpie alrededor de la zona donde se realizarán servicios para minimizar la contaminación.

Realización de mantenimiento con seguridad

Preparación de la máquina

Deben controlarse o reducirse las fuentes de energía almacenada (eléctricas, mecánicas, hidráulicas, neumáticas, químicas, térmicas, etc.) al mínimo practicable antes de realizar cualquier procedimiento de mantenimiento, reparación o servicio.

Prácticas de seguridad para prevenir posibles lesiones por fuentes que liberan energía:

- Desenganche la TDF antes de apagar el motor.
- Coloque los controles en la posición de estacionamiento o punto muerto antes de apagar el motor.
- Aplique el freno de estacionamiento o bloquee las ruedas.
- Espere hasta que todas las piezas móviles se detengan.
- Descienda la cortadora de césped hasta el suelo.
- Descienda los laterales de las cortadoras con laterales hasta el suelo.
- Apague el motor del tractor.
- Libere la presión del sistema hidráulico moviendo los controles varias veces en todas las direcciones.
- Trabe la ignición, retire la llave y llévesela.



Prepare los sistemas de la máquina para realizarles servicios

- Escuche y observe en busca de evidencias que indiquen piezas en movimiento antes de descender.
- Apoye o bloquee con seguridad la cortadora de césped antes de trabajar debajo de ella o de otros componentes elevados.
- Apoye, bloquee o trabe con seguridad los laterales de la cortadora con dispositivos de traba aprobados antes de trabajar cerca o debajo de una cortadora con laterales.
- Alivie la presión antes de desconectar o desarmar un sistema presurizado.
- Bloquee o alivie la presión de los resortes antes de desarmar un mecanismo cargado a resorte.
- Apoye o bloquee con seguridad cualquier componente elevado de la máquina antes de trabajar en él.
- Evite las llamas, las chispas y no fume cerca de combustibles, fluido hidráulico u otro material inflamable como los residuos de los cortes.

Realización de mantenimiento con seguridad

Fije una etiqueta con la advertencia “NO PONER EN FUNCIONAMIENTO” en todas las palancas de control y retire la llave de contacto si la cortadora de césped no debe ser utilizada. Llévese la llave.

Instale dispositivos de apoyo aprobados cuando trabaja debajo o cerca de equipos elevados.

¡ADVERTENCIA! Las cortadoras de césped u otros equipos elevados no apoyados pueden caerse de manera imprevista. **Nunca se introduzca debajo de equipos elevados si no están apoyados en dispositivos de apoyo aprobados.** La caída de equipos podría resultar en una lesión grave o la muerte por aplastamiento.

Retire sólo las guardas o cubiertas que permiten acceder a la zona donde se realizarán servicios. Vuelva a colocar todas las guardas y cubiertas cuando el trabajo esté terminado.

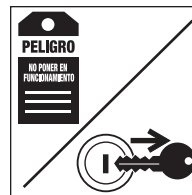

Use una “etiqueta que indique No poner en funcionamiento”



Utilice dispositivos de apoyo aprobados



Vuelva a colocar todas las guardas

Realización de mantenimiento con seguridad

Use ventilación adecuada

Si es necesario hacer funcionar un motor en una zona cerrada, elimine del área las emanaciones de escape con una extensión del caño de escape. Si no tiene esa extensión, asegúrese de abrir las puertas y dejar entrar aire del exterior.

¡ADVERTENCIA! Evite posibles lesiones. **Nunca trabaje en la maquinaria con el motor en funcionamiento salvo que así lo indiquen los manuales del fabricante para un servicio en particular.**

¡ADVERTENCIA! **Nunca haga funcionar ningún tipo de motor sin la ventilación adecuada: LAS EMANACIONES DEL ESCAPE PUEDEN SER MORTALES.**

Use gatos y malacates con cuidado

Los soportes o bloques de seguridad deben ubicarse en una parte rígida de la cortadora. No ubique soportes debajo de ejes o apoyos de ruedas que puedan girar.

Si debe trabajar debajo de equipos elevados, siempre use bloques de madera (**no de concreto**), soportes de gato u otros soportes rígidos y estables. Cuando use gatos o malacates, siempre asegúrese de que están correctamente apoyados.

¡ADVERTENCIA! Evite posibles lesiones por aplastamiento. **Nunca use bloques de concreto para apoyo.** Pueden colapsar bajo cargas incluso livianas.

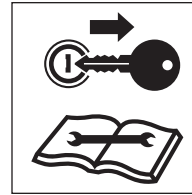

Retire la llave y lea el manual de mantenimiento

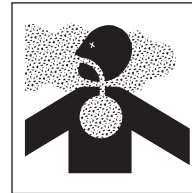

Ventile la zona de trabajo



Use un apoyo adecuado para los equipos elevados

Asegúrese de que los malacates o gatos que usa estén en buenas condiciones. Nunca use gatos con piezas rajadas, dobladas o retorcidas. Nunca use cables pelados, retorcidos o pellizcados. Nunca use ganchos doblados o deformados.

Realización de mantenimiento con seguridad

Prácticas de seguridad para tareas de mantenimiento comunes

Riesgos del combustible

¡ADVERTENCIA! Siempre use recipientes y/o equipos de distribución de combustible aprobados.

Los combustibles son inflamables; por eso, debe cumplir estas prácticas con el fin de reducir la posibilidad de un accidente grave.

- Apague el motor y la ignición mientras carga combustible.
- Siempre conecte a tierra la boquilla de combustible contra el cuello de llenado del depósito para evitar chispas.
- Mantenga las chispas y llamas abiertas alejadas del combustible.
- No fume mientras carga combustible o manipula recipientes con combustible.
- No corte ni suelde en líneas, tanques o recipientes de combustible ni cerca de ellos.
- No llene el depósito en exceso o derrame combustible. Limpie el combustible derramado de inmediato.

Riesgos del refrigerante de motor

Los sistemas de refrigeración con líquidos acumulan presión a medida que el motor se calienta; **tenga suma precaución antes de retirar la tapa del radiador.**

Asegúrese de:

- Detener el motor y esperar que el sistema se enfríe.
- Usar ropa de protección y anteojos de seguridad.
- Girar la tapa del radiador lentamente hasta el primer tope para permitir que la presión escape antes de retirar la tapa por completo.



No fumar; evitar las llamas abiertas



Retire la tapa del radiador lentamente

Realización de mantenimiento con seguridad

Riesgos del sistema hidráulico

El sistema hidráulico se encuentra bajo presión siempre que el motor está funcionando; puede conservar presión incluso después de apagar el motor. Haga funcionar todos los controles hidráulicos incluyendo el control hidráulico auxiliar después de que el motor esté apagado. Alivie la presión atrapada en las líneas después de que los accesorios están apagados y apoyados en el suelo.

Durante la inspección del sistema hidráulico:

- Espere que el fluido se enfríe antes de desconectar las líneas. El fluido hidráulico caliente puede causar **QUEMADURAS GRAVES**.
- **No** use las manos para verificar la presencia de fugas. En cambio, use un cartón o papel para buscar fugas.
- Use protección ocular adecuada. El fluido hidráulico puede causar lesiones oculares permanentes.

¡ADVERTENCIA! El fluido hidráulico bajo presión pueden penetrar la piel o los ojos y causar lesiones graves, ceguera o la muerte. Las fugas de fluido bajo presión pueden no ser visibles. **Utilice un cartón o una madera para buscar fugas, no la mano. Use una protección facial o antiparras de seguridad para proteger los ojos.** Si el fluido se inyecta en la piel, debe ser extraído dentro de las próximas pocas horas por personal médico familiarizado con este tipo de lesión.

Cuando ventila o llena el sistema hidráulico, afloje la tapa de llenado con lentitud y retírela gradualmente.

Nunca restablezca una válvula de alivio del sistema hidráulico a una presión mayor que la recomendada por el fabricante.

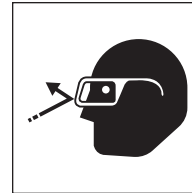

Use protección ocular



El fluido a alta presión puede inyectarse en el cuerpo

Realización de mantenimiento con seguridad

Riesgos del sistema eléctrico

Antes de trabajar en el sistema eléctrico, desconecte los cables de la batería.

- Retire primero los cables negativos (-) de la batería.
- Al reconectar la batería, conecte los cables negativos (-) de la batería al final.

El líquido del interior de las baterías contiene ácido, que es un **VENENO** y puede causar **QUEMADURAS QUÍMICAS GRAVES**.

Evite lesiones

- Use una protección facial para evitar el contacto con los ojos.
- Use guantes y ropa resistentes a los productos químicos para mantener al electrolito alejado de la piel y la ropa común.

¡ADVERTENCIA! El contacto con el electrolito daña los ojos y la piel. **Siempre use una protección facial para evitar que el electrolito penetre en los ojos.** Si el electrolito entra en contacto con los ojos, enjuague de inmediato con agua limpia y busque atención médica.

Use guantes de caucho y ropa de protección para mantener el electrolito lejos de la piel. Si el electrolito entra en contacto con la piel o la ropa, lave de inmediato con agua limpia.

Si se ingiere, busque atención médica de inmediato. **NUNCA** proporcione líquidos que induzcan el vómito.

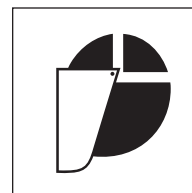

Use protección facial



Use indumentaria de protección

Realización de mantenimiento con seguridad

Evite explosiones

¡ADVERTENCIA! Evite posibles lesiones graves por explosiones. Las baterías de plomo-ácido producen gases sumamente explosivos, especialmente durante la carga. **Mantenga alejados los arcos, las chispas, las llamas y el tabaco encendido.**

- No fume cerca de las baterías.
- Mantenga los arcos, las chispas y llamas abiertas alejadas de las baterías.
- Proporcione ventilación adecuada.

Nunca revise la batería colocando un objeto metálico entre los bornes: la chispa resultante podría causar una explosión.

¡ADVERTENCIA! Evite posibles lesiones graves por explosiones de baterías. **No cargue baterías ni arranque con refuerzo el motor si la batería está congelada.** Caliente a 60 °F (15,5 °C) o la batería puede explotar y causar lesiones graves.

Reglas de seguridad durante el arranque con refuerzo de batería:

- Siga las instrucciones para el “arranque con refuerzo de batería” correcto como se especifica en el manual del fabricante.

- Asegúrese de que las máquinas no se estén tocando.
- Observe la polaridad de las baterías y conexiones.
- Realice la conexión final de cable al motor o al punto de tierra más alejado de la batería. Nunca realice la conexión final en el arrancador o la batería muerta: las chispas pueden encender gases explosivos presentes en la batería.
- Cuando desconecta cables después de un arranque con puente, retire los cables en el orden inverso al de la conexión (es decir, la conexión final primero).

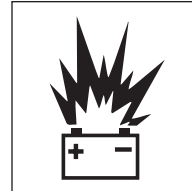

Evite las chispas y las llamas abiertas cerca de las baterías

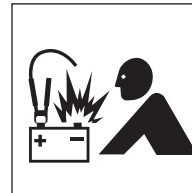

Para el arranque con refuerzo, observe la polaridad y realice la conexión final en el punto de descarga a tierra

Realización de mantenimiento con seguridad

Mantenimiento de neumáticos y ruedas

Revise los neumáticos y las ruedas a diario porque la estabilidad del tractor y la cortadora de césped puede verse significativamente afectada por la presión de los neumáticos o daños en los neumáticos o en las ruedas.

Revise los neumáticos para verificar:

- La presión correcta.
- Cortes y protuberancias.
- Clavos u otras pinchaduras.
- Desgaste desparejo o excesivo.
- Estado de los vástagos y tapas de las válvulas.

Revise las ruedas para verificar:

- Daños en las llantas.
- Tuercas o pernos faltantes o flojos.
- Desalineación.

Todos los servicios de neumáticos deben ser realizados por un centro de servicios para neumáticos cualificado o por una persona de servicio autorizada debidamente capacitada en los procedimientos y el uso del equipo de seguridad destinado a los servicios de neumáticos.

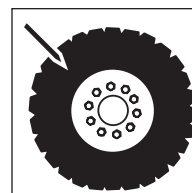

Revise los neumáticos y las ruedas en busca de daños

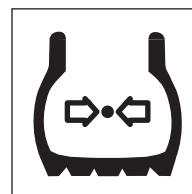

Mantenga la presión correcta en los neumáticos

Realización de mantenimiento con seguridad

Mantenimiento de neumáticos y ruedas (continuación)

¡ADVERTENCIA! Los tipos de ruedas y neumáticos que generalmente se encuentran en estos equipos requieren cuidados especiales al realizar servicios para evitar lesiones graves o la muerte.

No infle los neumáticos por encima de la presión recomendada. Asegúrese de volver a colocar el lastre de los neumáticos si está instalado. Consulte las especificaciones del fabricante para ver los requisitos de lastre.

Mantenga las tuercas de las ruedas apretadas según las recomendaciones del fabricante.

Es normal que la presión de los neumáticos aumente durante el funcionamiento; NO se debe reducir.

Nunca vuelva a inflar un neumático que se ha desinflado mucho o por completo sin retirar el neumático de la rueda. Haga inspeccionar atentamente el neumático y la rueda para detectar daños antes de volverlos a armar.

Al agregar aire a un neumático, hágalo desde cierta distancia. Use una manguera larga con mandril de autofijación. Siempre párese detrás de la trocha cuando ajusta la presión de un neumático.

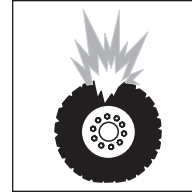

Evite la explosión de los neumáticos

No infle neumáticos con gases inflamables o con sistemas que usan un inyector de alcohol.

Nunca corte o suelde una rueda con un neumático inflado instalado en ella. Esto podría causar descompresión explosiva.

Verifique que el tamaño del neumático y la rueda coincidan correctamente.

Cuando reemplaza neumáticos, asegúrese de que sean de la clasificación adecuada especificada por el fabricante.

Los neumáticos no deben funcionar a velocidades más altas que las nominales. La mayoría de los neumáticos para agricultura están clasificados para una velocidad máxima de 20 mph (32 km/h).

Realización de mantenimiento con seguridad

Servicio y reparaciones completas antes de liberar la máquina

Apriete todos los pernos, accesorios y conexiones con las torsiones especificadas por el fabricante.

Instale todas las guardas, cubiertas y escudos después de realizar los servicios. Reemplace o repare los que estén dañados. Llene y recargue los sistemas a presión sólo con los fluidos aprobados o recomendados por el fabricante.

Arranque el motor y revise para detectar fugas. (Consulte la página 23, **Riesgos del sistema hidráulico**.) Haga funcionar todos los controles para asegurarse de que el tractor y la cortadora de césped funcionan correctamente. Pruebe la máquina si es necesario. Después de las pruebas, apague y verifique el trabajo realizado. ¿Falta algún pasador, arandela, tuerca de seguridad, etc.? Vuelva a revisar todos los niveles de fluidos antes de liberar la máquina para el funcionamiento.

Todas las piezas deben ser inspeccionadas durante la reparación y deben reemplazarse si están gastadas, rajadas o dañadas. Las piezas excesivamente gastadas o dañadas pueden fallar y causar lesiones o la muerte.

Reemplace cualquier letrero dañado o ilegible.



Verifique el trabajo de servicio cuando está completo

Mantenimiento de las hojas de la cortadora

No corra riesgos usando hojas dañadas o dobladas. Los fabricantes de cortadoras de césped de la Asociación de Fabricantes de Equipos (Association of Equipment Manufacturers, AEM) y la Asociación de Fabricantes de Equipos para Agricultura (Farm Equipment Manufacturers Association, FEMA) piden que las hojas de cortadoras NO se reutilicen, enderecen, refuercen en su superficie o suelden. Si una hoja rota es arrojada por una cortadora, podrían producirse lesiones graves o la muerte.

Realización de mantenimiento con seguridad

Mantenimiento de las hojas de la cortadora (continuación)

- **¿Cómo están hechas las hojas de la cortadora de césped?** Están hechas acero para resortes de aleación de alta resistencia. Se forjan en caliente y se les da forma para cumplir con las especificaciones individuales del fabricante; luego, se tratan y templean a un estado dúctil, de alta resistencia para reducir la posibilidad de rupturas durante el corte. Las hojas se prueban para garantizar que cumplan con las normas de resistencia, dureza y ductilidad. Si una hoja no cumple con alguna de estas especificaciones, no se utilizará en la cortadora de césped.
- **¿Qué sucede cuando se dobla una hoja de la cortadora?** Se necesita una gran fuerza de impacto para doblar la hoja. Esta fuerza de impacto a menudo resulta en que las hojas se agujerean o marcan. Una vez que una hoja está dañada por un agujero o una marca, es mucho más probable que ocurra una falla de la hoja. Cuando una hoja está gravemente doblada, puede crearse una rajadura microscópica en ella. Enderezar la hoja no quita o repara esta rajadura, sino que puede causar rajaduras adicionales. Tensiones adicionales durante los trabajos de corte pueden resultar en una falla imprevista de la hoja.
- **Evite doblar las hojas.** Contribuya a prevenir que las hojas de la cortadora se doblen o rajen evitando el contacto con objetos sólidos. Las hojas de la cortadora de césped están destinadas a cortar hierba, arbustos, vegetación leñosa y árboles y ramas pequeños. No están diseñadas para entrar en contacto con objetos sólidos como roca, cemento o postes de acero. Inspeccione la zona antes de usar la cortadora. Retire o marque claramente los objetos sólidos y corte alrededor de ellos.
- **Sustituya las hojas dañadas!** Inspeccione las hojas de la cortadora diariamente o después de golpear algún objeto sólido. Si una hoja de la cortadora de césped se daña (está doblada, agujereada, rajada) o desgasta más del 25 por ciento del tamaño original, debe retirarse y sustituirse con una nueva. Siempre use las hojas originales del fabricante. Las hojas de marcas no originales pueden no cumplir con los requisitos de resistencia, dureza y ductilidad del fabricante de la cortadora.
- **No corra riesgos usando hojas dañadas o dobladas.** El uso de una hoja de cortadora dañada o enderezada puede resultar en la ruptura de la hoja y que la hoja sea arrojada hacia el operador o una persona ajena causando una lesión grave o la muerte. El precio de una nueva hoja es bajo en comparación con la posibilidad de una lesión grave que podría resultar de una hoja doblada o rota arrojada por la cortadora

Palabras finales para el usuario

Acaba de terminar de leer el Manual de la cortadora de césped industrial y para agricultura AEM. Es imposible que este manual abarque todas las situaciones de seguridad que se podría encontrar a diario. Su conocimiento de estas precauciones de seguridad y de su cumplimiento de las reglas básicas de seguridad

contribuirán a formar un buen juicio en todas las situaciones. Nuestro objetivo es ayudarlo a desarrollar, establecer y mantener buenos hábitos de seguridad para que la operación de una cortadora de césped industrial y para agricultura le resulte más fácil y más segura.

Éste es otro manual de una serie publicada por AEM sobre la operación de maquinaria en condiciones de seguridad. Muchas de las ilustraciones de este manual de seguridad se pueden encontrar y descargar en <http://pictorials.aem.org>. Para obtener publicaciones adicionales, visite nuestro sitio web en www.safetymaterials.org.



ASOCIACIÓN DE FABRICANTES
DE EQUIPOS

Correo electrónico: safetymaterials@aem.org
www.aem.org

INTRODUCTION SECTION

Introduction Section 2-1

INTRODUCTION

INTRODUCTION

We are pleased to have you as a Rhino customer. Your Rotary Cutter has been carefully designed with care and built with quality materials by skilled workers to give maximum service with minimum down time. This manual is provided to give you the necessary operating and maintenance instructions for keeping your rotary cutter in top operating condition. Careful use and timely service saves extensive repairs and costly downtime losses. Please read this manual thoroughly. Understand what each control is for and how to use it.

Rhino typically offers three types of shielding to protect the operator, passerby, livestock, and property from thrown objects... deflectors, single chain guards, and double chainguards. Shielding should be selected based on the intended use of the mower. Double chainguards or deflectors should be used for highway, right-of-way, parks or greenbelt mowing or all other mowing where human dwellings, vehicles, or livestock could be within 300 feet of the mower. Chainguards are more durable, provide a longer service life and require less maintenance and replacement than deflectors. Single chainguards may be sufficient for agriculture and other mower use only where passersby or property are not within 300 feet of the mower during operation.

No shielding is 100% effective in preventing thrown objects. The possibility of injury and property damage from this hazard can be substantially reduce by selecting proper shielding, maintaining the mower and shielding in good operational condition, inspecting the area for foreign debris before mowing, operating the mower at a minimum cutting height of 4", and keep unprotected persons at a minimum distance of 300 feet from the mower at all times during operation.

Safety is of primary importance to the owner/operator and to the manufacturer. Observe all safety precautions decaled on the machine and noted throughout the manual for safe operation of implement. If any assistance or additional information is needed, contact your authorized Rhino dealer. The owner/operator/dealer should know and understand the Safety Messages before assembly and be aware of the hazards of operating this cutter during assembly, use, and maintenance. The Safety Alert Symbol combined with a Signal Word, as seen below, is intended to warn the owner/operator of impending hazards and the degree of possible injury faced when operating this machine.



Indicates an imminently hazardous situation that, if not avoided, WILL result in DEATH OR VERY SERIOUS INJURY.



Indicates an imminently hazardous situation that, if not avoided, COULD result in DEATH OR SERIOUS INJURY.



Indicates an imminently hazardous situation that, if not avoided, MAY result in MINOR INJURY.

Important

Identifies special instructions or procedures that, if not strictly observed, could result in damage to, or destruction of the machine, attachments or the environment.

INTRODUCTION

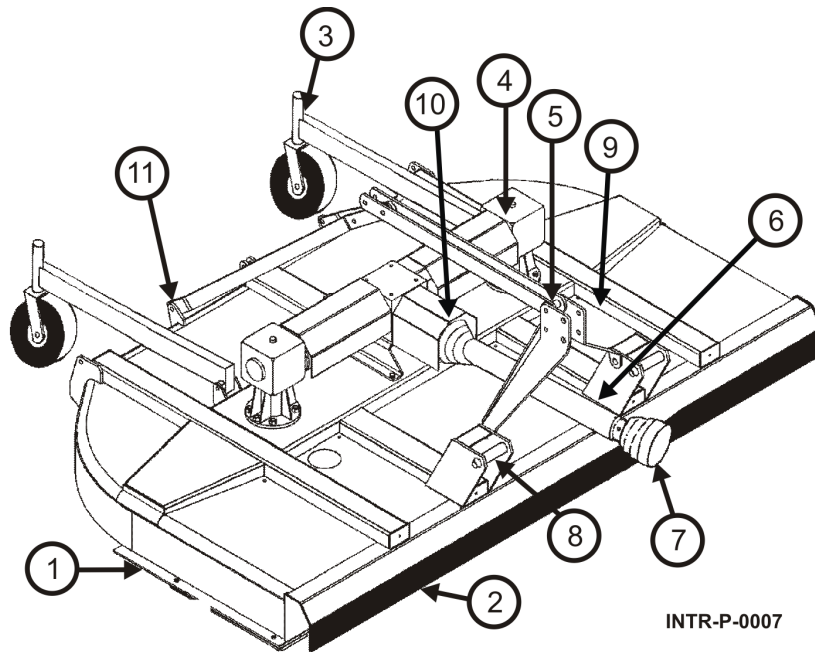

- 1 Skid Shoe
- 2 Thrown Objects Guard
- 3 Tailwheel
- 4 Gearbox
- 5 Top 3pt Hitch Pin
- 6 Driveline Storage Support
- 7 Input Driveline
- 8 Lower 3PT Hitch Pins
- 9 Operator's Manual Canister
- 10 Driveline Clutch
- 11 Height Adjustment

INTR-P-0007

INTRODUCTION

The Rhino TW120 Rotary Mower is designed for medium duty applications such as weed, grass, corn stalks, and light brush to 2" diameter. These mowers are single spindle with two free-swinging blades. Free swinging blades reduce the shock of impact when a stationary object is hit. Additional protection is provided by a slip clutch on the gearbox input shaft. A round blade holder allows the mower to "ride over" stumps and similar immovable objects. These Mowers are attached to the tractor using 3-point Cat II-III or Cat II-III quick Hitches. Standard equipment includes driveline shields, clutch shields and front and rear discharge shields.

Equipment Specifications

Cutting Width	120"		540 PTO	1000 PTO
Transport Width	127"	Blade Tip Speed		
Overall Width	127"	Center	15,423 FPM	16,166 FPM
Overall Length	116" (Lift), 156" (Pull)	Gearbox Rating		
Cutting Height	2-12"	Center Gearbox	120 HP	120 HP
HP Required (min)	80 HP (Lift), 50 HP (Pull)	Outboard Gearbox	100 HP	100 HP
Cutting Capacity (max)	3"	Limited Warranty	5 Year	5 Year
Weight	2586 lbs	Driveline Size	CAT 4	CAT 4
Tongue Weight	1070 lbs.	Limited Warranty	1 Year	1 Year

INTRODUCTION

KEY OPERATION POINTS

- Cutting performance and distribution are best when cutter is level from side to side and front to rear.
- In extra heavy material, rear chains will allow better discharge and better distribution than solid rear bands.
- Never operate the Mower below full PTO speed of 540 or 1000 rpm.
- Corn should be cut at 5 to 6 mph. If full PTO rpm cannot be maintained, use one lower gear.

Operating Noise Level/Sound Pressure

The sound levels at the operator's ear from the attached machine (rotary cutter) are at least 10 dB(A) below the levels from typical Agricultural tractors used to power and transport this machine. Therefore, the Noise emission values given by the OEM of the Agricultural tractor used to power and transport this machine would be valid when this machine is attached to and operated by that Agricultural tractor in all OEM recommended applications.

Warranty information

In addition to the standard Limited Warranty shown on the facing page, Rhino also provides:

1. A FIVE-YEAR (60 months) LIMITED WARRANTY* on GEARBOX components provided they have been properly maintained† and have not been subjected to abuse or mis-use except as limited below.

* WARRANTY LIMITATIONS - GEARBOX

A. Warranty is ONE-YEAR (12 MONTHS) for Seals (After one year, seals are considered to be WEARING PARTS and replacement is the users' responsibility.)

B. Users' Gearboxes may be rebuilt by Rhino or replaced by new or rebuilt Gearboxes at the option of Rhino.

2. ONE-YEAR (12 months) LIMITED WARRANTY** on the DRIVELINE components provided they have been properly maintained† and have not been subjected to abuse or mis-use.

* *WARRANTY LIMITATIONS - DRIVELINE

A. Warranty is ONE-YEAR (12 MONTHS) for DRIVELINE SHIELDS except that evidence of wear from contact with other parts on the shield voids this warranty.

B. Shield Bearings are wearing parts and are not warrantable.

C. Slip-Clutch Disks are wearing parts and are not warrantable. Evidence of "burning up" Slip Clutch Plates due to improper adjustment will void warranty on Slip Clutch Parts.

INTRODUCTION

RHINO LIMITED WARRANTY

1. LIMITED WARRANTIES

- 1.01. Rhino warrants for one year from the purchase date to the original non-commercial, governmental, or municipal purchaser ("Purchaser") and warrants for six months to the original commercial or industrial purchaser ("Purchaser") that the goods purchased are free from defects in material or workmanship.
- 1.02. Manufacturer will replace for the Purchaser any part or parts found, upon examination at one of its factories, to be defective under normal use and service due to defects in material or workmanship.
- 1.03. This limited warranty does not apply to any part of the goods which has been subjected to improper or abnormal use, negligence, alteration, modification, or accident, damaged due to lack of maintenance or use of wrong fuel, oil, or lubricants, or which has served its normal life. This limited warranty does not apply to any part of any internal combustion engine, or expendable items such as blades, shields, guards, or pneumatic tires except as specifically found in your Operator's Manual.
- 1.04. Except as provided herein, no employee, agent, Dealer, or other person is authorized to give any warranties of any nature on behalf of Manufacturer.

2. REMEDIES AND PROCEDURES.

- 2.01. This limited warranty is not effective unless the Purchaser returns the Registration and Warranty Form to Manufacturer within 30 days of purchase.
- 2.02. Purchaser claims must be made in writing to the Authorized Dealer ("Dealer") from whom Purchaser purchased the goods or an approved Authorized Dealer ("Dealer") within 30 days after Purchaser learns of the facts on which the claim is based.
- 2.03. Purchaser is responsible for returning the goods in question to the Dealer.
- 2.04. If after examining the goods and/or parts in question, Manufacturer finds them to be defective under normal use and service due to defects in material or workmanship, Manufacturer will:
 - (a) Repair or replace the defective goods or part(s) or
 - (b) Reimburse Purchaser for the cost of the part(s) and reasonable labor charges (as determined by Manufacturer) if Purchaser paid for the repair and/or replacement prior to the final determination of applicability of the warranty by Manufacturer.

The choice of remedy shall belong to Manufacturer.

- 2.05. Purchaser is responsible for any labor charges exceeding a reasonable amount as determined by Manufacturer and for returning the goods to the Dealer, whether or not the claim is approved. Purchaser is responsible for the transportation cost for the goods or part(s) from the Dealer to the designated factory.

3. LIMITATION OF LIABILITY.

- 3.01. MANUFACTURER DISCLAIMS ANY EXPRESS (EXCEPT AS SET FORTH HEREIN) AND IMPLIED WARRANTIES WITH RESPECT TO THE GOODS INCLUDING, BUT NOT LIMITED TO, MERCHANTABILITY AND FITNESS FOR A PARTICULAR PURPOSE.
- 3.02. MANUFACTURER MAKES NO WARRANTY AS TO THE DESIGN, CAPABILITY, CAPACITY, OR SUITABILITY FOR USE OF THE GOODS.
- 3.03. EXCEPT AS PROVIDED HEREIN, MANUFACTURER SHALL HAVE NO LIABILITY OR RESPONSIBILITY TO PURCHASER OR ANY OTHER PERSON OR ENTITY WITH RESPECT TO ANY LIABILITY, LOSS, OR DAMAGE CAUSED OR ALLEGED TO BE CAUSED DIRECTLY OR INDIRECTLY BY THE GOODS INCLUDING, BUT NOT LIMITED TO, ANY INDIRECT, SPECIAL, CONSEQUENTIAL, OR INCIDENTAL DAMAGES RESULTING FROM THE USE OR OPERATION OF THE GOODS OR ANY BREACH OF THIS WARRANTY. NOTWITHSTANDING THE ABOVE LIMITATIONS AND WARRANTIES, MANUFACTURER'S LIABILITY HEREUNDER FOR DAMAGES INCURRED BY PURCHASER OR OTHERS SHALL NOT EXCEED THE PRICE OF THE GOODS.
- 3.04. NO ACTION ARISING OUT OF ANY CLAIMED BREACH OF THIS WARRANTY OR TRANSACTIONS UNDER THIS WARRANTY MAY BE BROUGHT MORE THAN TWO (2) YEARS AFTER THE CAUSE OF ACTION HAS OCCURRED.

4. MISCELLANEOUS.

- 4.01. Proper Venue for any lawsuits arising from or related to this limited warranty shall be only in Guadalupe County, Texas.
- 4.02. Manufacturer may waive compliance with any of the terms of this limited warranty, but no waiver of any terms shall be deemed to be a waiver of any other term.
- 4.03. If any provision of this limited warranty shall violate any applicable law and is held to be unenforceable, then the invalidity of such provision shall not invalidate any other provisions herein.
- 4.04. Applicable law may provide rights and benefits to purchaser in addition to those provided herein.

KEEP FOR YOUR RECORDS

ATTENTION: Purchaser should fill in the blanks below for his reference when buying repair parts and/or for proper machine identification when applying for warranty.

Rhino Implement Model _____ Serial Number _____

Date Purchased _____ Dealer _____

ATTENTION:

READ YOUR OPERATOR'S MANUAL

RHINO®

1020 S Sangamon Ave.
Gibson City, IL 60936
800-446-5158
E-mail: parts@servis-rhino.com



TW120 01/11

Introduction Section 2-5

ASSEMBLY SECTION

Assembly Section 3-1

ASSEMBLY

DEALER SETUP INSTRUCTIONS

The mower as received from the factory is partially assembled and requires minimum time to complete assembly and is ready for sale.





This mower is shipped vertically with shipping brackets. These shipping brackets are intended for use in transporting the mower from the factory to dealer.



DO NOT use these brackets to store the unit. **DO NOT** store mower vertically, the mower can fall over resulting in serious injury or death. To avoid injury always store mower lying down on flat ground.

Assembly will be easier if components are aligned and loosely assembled before tightening hardware. Refer to bolt torque chart in Maintenance Section. All bolts are grade 5 unless otherwise specified.

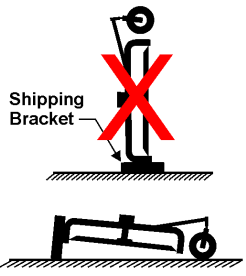
ASSEMBLY

 WARNING		 ADVERTENCIA	
Crushing Hazard		Riesgo de Aplastamiento	
To avoid injury from mower falling over: <ul style="list-style-type: none">• DO NOT store mower vertically on shipping brackets.• Store mower lying down.		Para evitar lesión por la caída de la cortadora: <ul style="list-style-type: none">• NO almacene la cortadora verticalmente en los soportes de transporte.• Almacene en posición acostada.	

D454

A-FRAME ASSEMBLY-LIFT TYPE

1. Insert bushing (5) into lower end of each A-Frame half (1 & 2). Position each A-Frame half so the large hole in the top is towards the tractor. Install 3/4" x 2" bolt (10) with Flatwasher (14) through bushing (5) in A-Frame half (1 & 2) and rear hole in inside Main Frame lug. Install locknut.
2. Install bushing (8) between braces (3) through top rear hole of A-frame and insert bolt (12), flatwasher (14) and locknut (13).
3. Install bushing (22) between A-Frame halves (1 & 2) and insert bolt (23) and locknut (13). Install bushings (6) through Braces (4) and install bolt 3/4" x 5" (10), flatwashers (14) and locknut (13).
4. Attach Braces (3) to Braces (4) with bushings (6), flatwashers (14), bolt 3/4" x 2-1/2" (16), and locknut (13). Retain the rear of Braces (3) together with bushing (15), bolt 3/4" x 2-1/2" (11) and locknut (13). Attach braces (4) together with bolt 3/4" x 1-1/2" (17) and locknut (13).
5. Install Brace supports (4) to the rear lugs on the Main Frame with bolts 3/4" x 2" (10), flatwashers (14), bushings (6) and locknuts (13).

ASSEMBLY

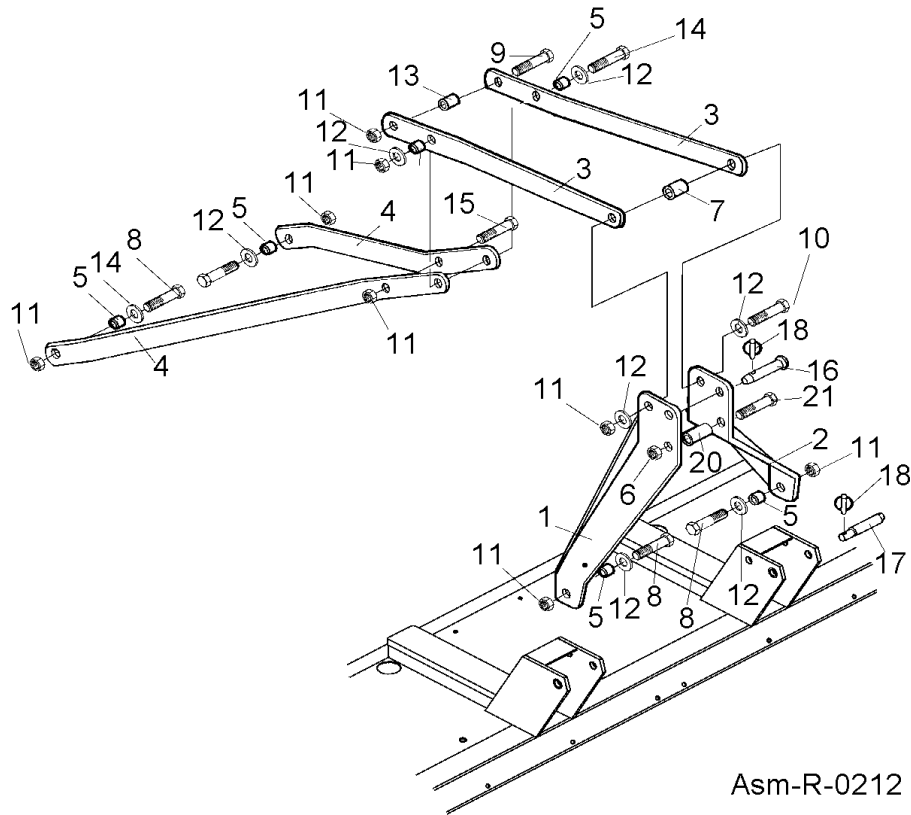

Asm-R-0212

ASSEMBLY

ITEM	QTY	DESCRIPTION
1.	1	A-Frame - RH
2.	1	A-Frame - LH
3.	2	Brace
4.	2	Brace
5.	6	Bushing 1-1/8OD x 9/16 Lg
6.	1	Nut
7.	2	Spacer
8.	2	Bolt
9.	1	Bolt
10.	2	Bolt
11.	9	Nut
12.	8	Washer
13.	1	Spacer
14.	2	Bolt
15.	1	Bolt
16.	1	Pin
17.	2	Pin
18.	3	Clip
19.	1	Bushing 1 1/4 x 2 1/8 Lg
20.	1	Bolt
21.	1	Nut

TW120 01/11

Assembly Section 3-3

ASSEMBLY

ASSEMBLY

TAIL WHEEL ASSEMBLY - LIFT TYPE

1. Attach Beam Support Weldments (2) to the Main Frame Assembly with 1/2" x 1-1/2" Bolts (6) & Locknuts(7).
2. Slide the Beam Weldment (1) through Bracket (3) and attach to the Mower Lugs with 5/8" x 4-1/2" Bolt(4) and Locknut(5).
3. Install 1/2" x 1-1/2" Bolts (6) through Beam Support Weldment (2) and Bracket (3). (Install through pair of holes which will give approximate desired cutting height). Install Locknut (7).

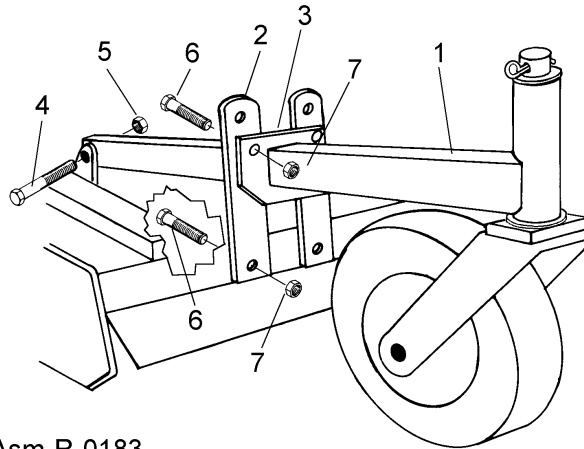

Asm-R-0183



The Components of these machines are quite heavy. Block all components up securely before working under or putting extremities under such parts.

TONGUE - PULL TYPE

Insert tongue lugs between mainframe uprights and retain using Bushings & Special Pins. Insert Retaining Clip to Special Pins. See Figure Asm-R-0136.

ASM-R-0136

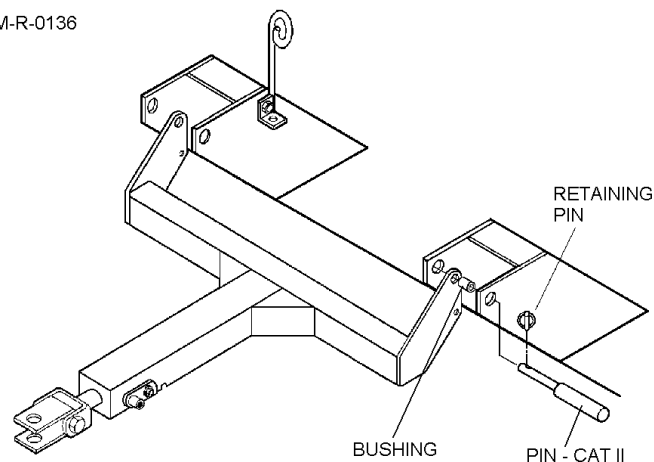

ASSEMBLY

AXLE ASSEMBLY - PULL TYPE

Attach the Rear Axle to the lugs on the rear of the Mainframe using (4) 3/4 x 3-1/2 bolts (#1), (1) 3/4 x 3 bolt (#2), (5) bushings (#3), (5) Locknuts (#4) and (4) Flatwashers. See Figure Asm-R-0184.

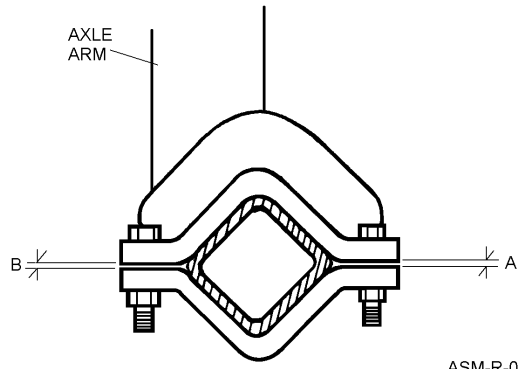
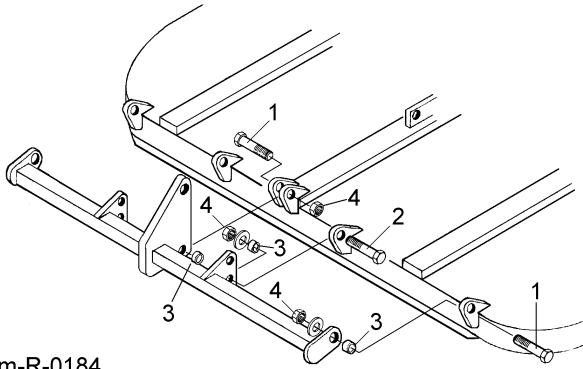

ASSEMBLY

Attach the Axle Arms to the Main Axle maintaining Dim. A approximately equal to Dim. B when clamp bolts are tightened. However, these Dim. may vary slightly if needed to help level the Mower Deck from side to side.

NOTE: Axle arms may be moved on the main tube to the desired wheel tread but it is always recommended that wheels be placed as wide as possible for stability. See Figure Asm-R-0139.

CONTROL RODS - PULL TYPE

Attach the two level-lift control rods to the lower lugs on tongue and to lugs on the rear axle tube using pins, washers and cotter pins.

NOTE: The adjusting nuts on control rods should be to rear of machine and should always be adjusted with equal tension on both rods. Figure Asm-R-0140 & Asm-R-0141.

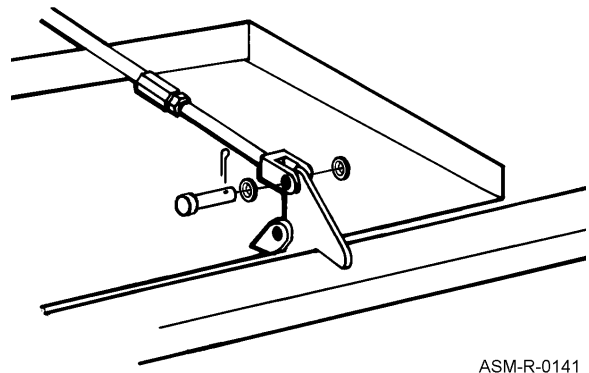
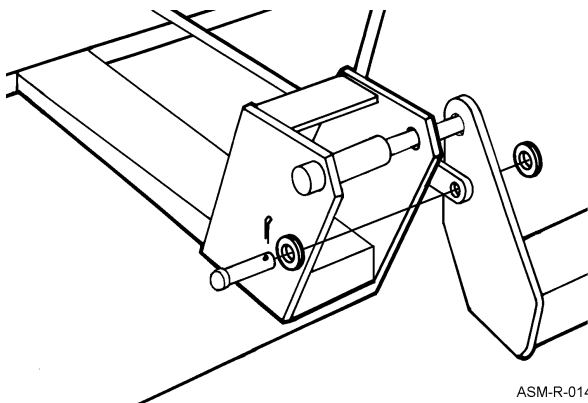

ASSEMBLY

CUTTER LEVELING

Often when the unit is first assembled and placed on a horizontal surface, the cutter is not level front to rear or side to side. Proper leveling must be obtained in order to prevent skid shoes from plowing in the dirt and to obtain a clean, level cutting performance.

Leveling must first be conducted left to right with measurements being taken at the front corner of the mower deck from the ground to the bottom of the skid shoe. If the two dimensions measured are not equal, the cutter must be leveled left to right. This may be done by the following procedure:

Using the axle arm assembly on the high side of the cutter deck, loosen the bottom two clamp bolts one or two turns and tighten the top two clamp bolts. This should be done in an alternating sequence, measuring the height of the skid shoes after each adjustment. Continue with this process until no additional leveling from side to side can be obtained. If the unit is still not level, work must then be done on the axle arm assembly which is on the low side of the cutter.

This cannot be done until the weight of the cutter is removed from the axle arm by placing a jackstand underneath the cutter and putting the hydraulic valve in the float position (or loosening the ratchet hack if the hydraulic cylinder is not used), which will then release pressure on the cylinder and the load on the axle arm.

Once this has been done, the axle arm may be adjusted by first loosening the top two bolts one or two turns and then tightening the bottom two bolts. After each adjustment, the cutter should be lifted off of the jackstand using the hydraulic cylinder or ratchet jack and then placed back on the jackstand if further adjustment is needed. This process should be continued until the cutter becomes level left to right.

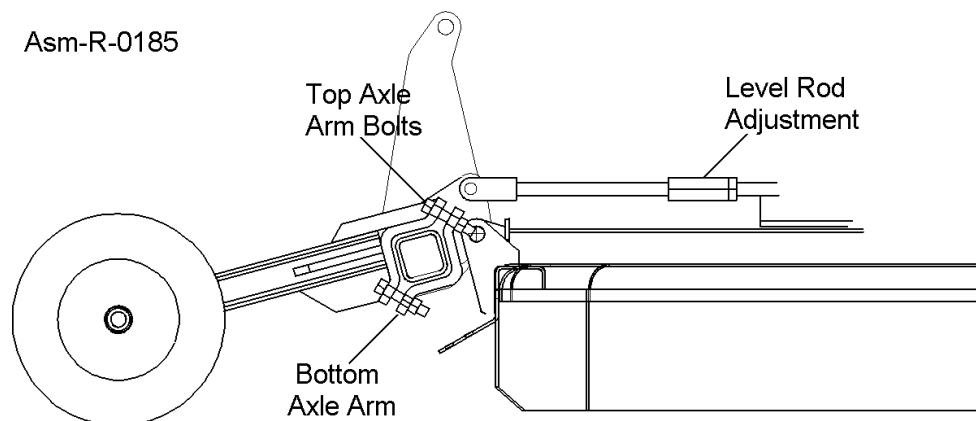

Once leveling from side to side has been completed, leveling from front to rear should be done. To level the cutter from front to rear, the leveling rod which links the tongue and the rear axle must be adjusted. To lower the front, lengthen the level rods and to raise the front, shorten the level rods. **IMPORTANT:** Adjust level rods the same length to maintain equal tension in rods. Improper adjustment may cause rods to snap or bend.

Once machine has been leveled according to directions, the cutting height can be set.

ASSEMBLY

HYDRAULIC OR MANUAL LIFT

Attach the Spring Assembly option (**FIGURE Asm-R-0186**) to the lug on the cutter deck behind the Center Gearbox. Retain using 3/4 x 3 capscrew and locknut. Install the Hydraulic Cylinder (**FIGURE Asm-R-0187**) or the manual Ratchet Lift Screw (**FIGURE Asm-R-0187**) between the Axle Center Lug and the Lug directly behind the Center Gearbox. Tighten all Bolts securely.

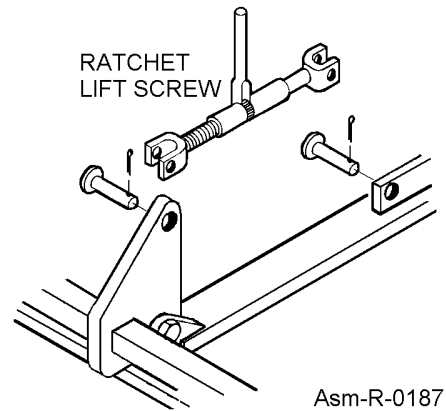
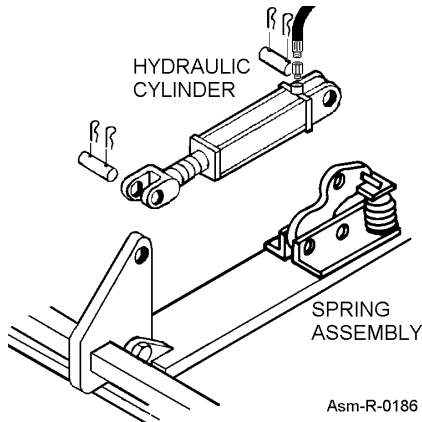

WHEELS - PULL TYPE

Install the Wheels on the Wheel Hubs.

Note: If Laminated Tires are used, place the flat side of the Lug Nut against the Wheel. Note direction of travel and curvature of rubber segments in tire and install as shown in **FIGURE Asm-R-0127**.

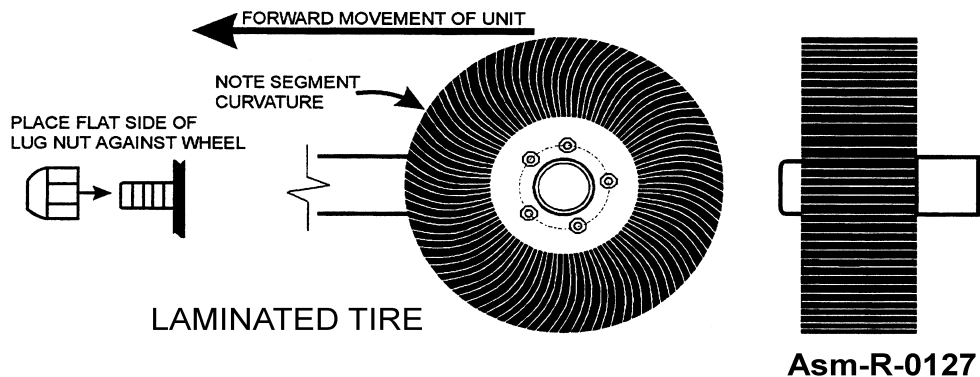

ASSEMBLY

DRIVELINE ATTACHMENT

Before starting assembly, make certain that all paint, dirt, and grease are removed from gearbox shaft (1). To ease assembly apply a light coat of grease to splines and assemble. Do not assemble a driveline without a shield.

1. Attach the slip clutch end of the driveline to the gearbox input shaft securely. Make certain that the slip clutch is fully onto the input shaft splines. Tighten the locknuts (2) alternately until they have reached the proper torque. Refer to Torque Chart in Maintenance Section.

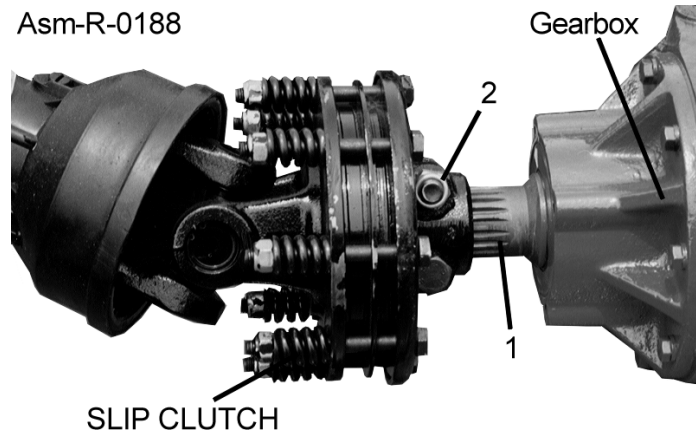

SHIELD ASSEMBLY

Remove and discard the two top bolts from the Center Gearbox. Attach Bracket (1) to the Center Gearbox with M10 x 40 Bolts (2), and Flatwashers (3) in the same hole location. Install Shield (5) and retain with 1/2" Wing Nut (4).

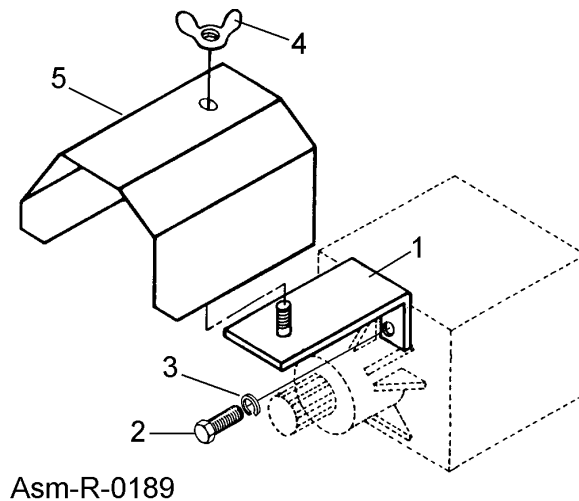

ASSEMBLY

JACKSHAFT BEARING SUPPORT ASSEMBLY

Attach the Jackshaft bearing support bracket (1) to the tongue. Loosely attach bearing support by using pivot bolt (3) with bushing (6). Install Bearing and housing assembly (4). Install spacers (5) and bolt (2) leaving installed loosely. Tighten bolt (2) NOTE: Do not tighten to point of collapsing spacer (5). Tighten pivot bolt (3) NOTE: Do not over tighten. Make sure Carrier Bearing (4) pivots in supports and complete assembly pivots on lower bolt. Slide Jackshaft through bearing (4).

NOTE: Install Bearing Assembly with snap ring facing Jackshaft. Bearing should be rigidly attached to jackshaft when shipped. If not apply loctite 609 between shaft and bearing to lock in place.

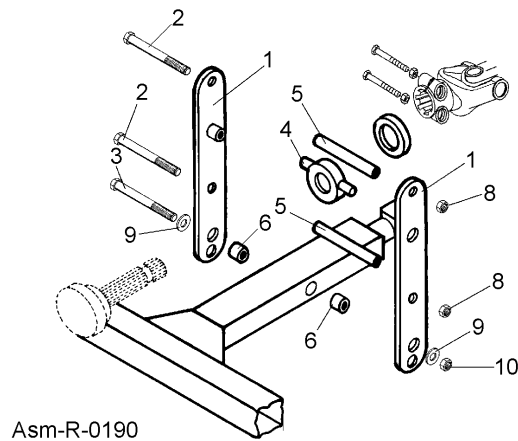

CV JACKSHAFT SUPPORT ASSEMBLY

Insert the splined end of Jackshaft into the Bearing (6) and attach the Jackshaft Mount (1) to the Tongue with 5/8" x 2" bolt (2), flatwasher (3), and locknut (4) as shown in **Figure Asm-R-0155**. Attach Jackshaft Support (7) to Mount (1) using 5/8" x 1-1/2" bolts (5) and locknut (4). Clamp top and middle section of Support by using 1/2" x 7" bolts (10) and locknuts (8), placing Spacers (9) between Supports.

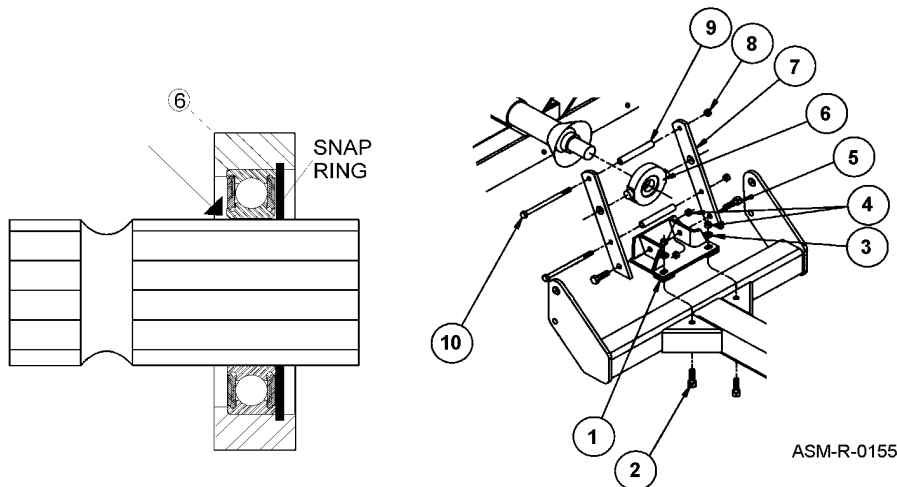

Intensionally Bearing Assembly with snap ring facing Jackshaft. Bearing should be rigidly attached to jackshaft when shipped. If not apply loctite 609 between shaft and bearing to lock in place.

ASSEMBLY

DRIVELINE CLAMP CONE YOKE OPERATING INSTRUCTIONS

Loosen the yoke clamp cone with a 11/16" (17mm) wrench and remove the cone from yoke. Slide yoke onto the shaft and align hole for clamping cone with annular groove of gearbox shaft. Reinstall cone and tighten (75 lb.-ft. torque). Push and pull the driveline to ensure it is securely attached to the shaft. Regularly check the driveline yoke to ensure a tight connection. To remove the yoke, remove the connecting cone and pull yoke off the shaft. If the cone cannot be easily removed by hand, drive it out from the other side using a hammer and punch.

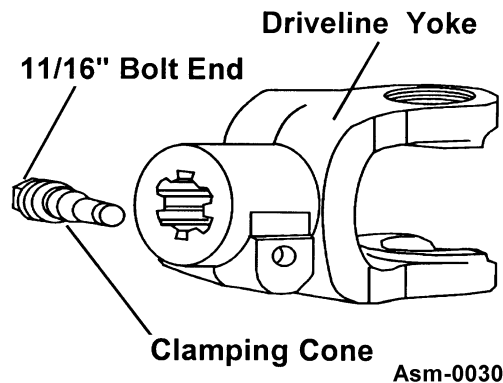

NOTE: The clamping cone is serviced only as a complete assembly. Do not attempt to disassemble the clamping cone

FRONT AND REAR DEFLECTORS (Standard Equipment)

CHAIN GUARDS (Optional Equipment at extra cost)



Front and Rear rubber-fabric Deflectors are Standard Equipment and Front and Rear Chain Guards are optional at extra cost. One type of guards must be installed (and maintained in good repair) except for agricultural purposes only in areas where persons, vehicles, livestock, or other property will not be endangered by thrown objects and where such safety equipment would prevent the mower's reasonable performance of its assigned agricultural task.

DEFLECTORS: Front and Rear Deflectors (Standard Equipment) are recommended for the average user and will provide protection from thrown objects with proper operation under normal conditions. Deflectors must be maintained in good repair or replaced after no more than two inches of wear off lower edge.

Attach the front rubber Deflectors (1) to the Cutter with bracket Straps (2), 1/2" x 1-1/4" Bolts (3), Flatwashers (4) and Locknuts (5).

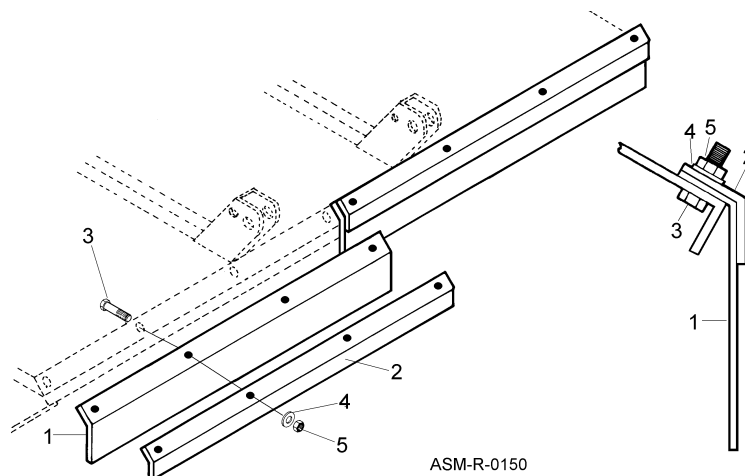

ASSEMBLY

Rear Deflector

Attach the rear rubber Deflectors (1) to the Cutter with bracket Straps (2), 1/2" x 1-1/4" Bolts (3), Flatwashers (4) and Locknuts (5)

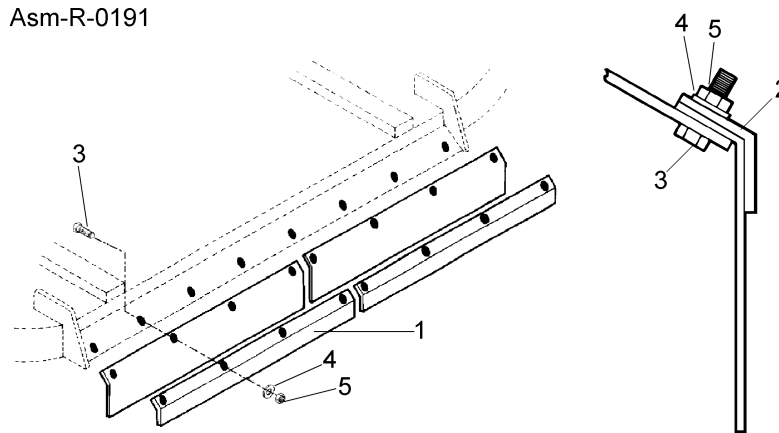

CHAIN GUARD (EXTRA EQUIPMENT)

CHAIN GUARDS: Front and Rear Chain Guards (Optional Equipment) are recommended for higher than normal usage (100 hours or more per year) and will provide protection from thrown objects with careful operation. Chain Guards must be maintained in good repair by replacing missing or worn sections or by being replaced when seriously worn or damaged.

Front Chain Guards

Attach the right and left Chain Guard assemblies (1) to the Cutter with 1/2" x 1-1/4" Bolts (2), Flatwashers (3), and Locknuts(4).

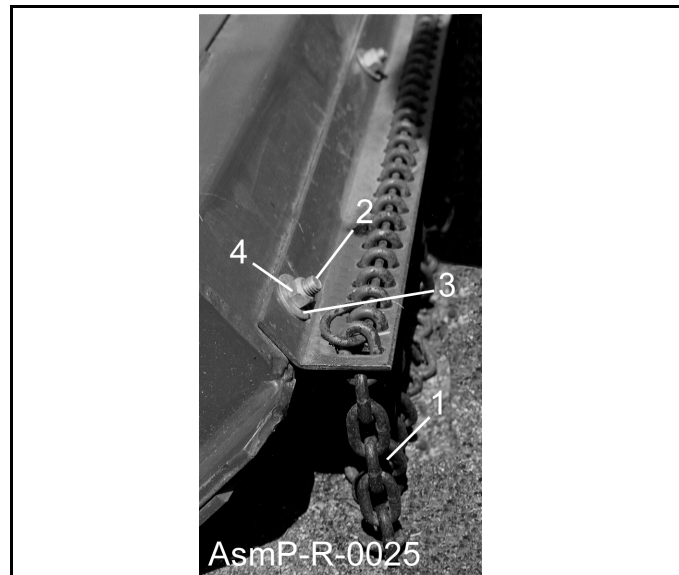

ASSEMBLY

Rear Chain Guards

Attach the right and left Chain Guard assemblies (1) to the Cutter with 1/2" x 1-1/4" Bolts (2), Flatwashers (3), and Locknuts(4).

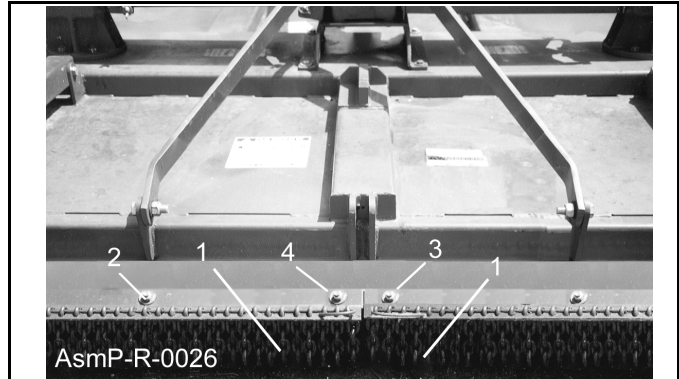

CHECK CHAINS (EXTRA EQUIPMENT) FOR LIFT-MODELS

Check Chains are available for attachment to front of Cutter as an accessory. Check chains are used to control cutting height and especially to allow Cutter to be lowered to the same preset cutting height effortlessly.

Install lower end of check chain (4) to hitch ears (6) through lower holes (7) using bolts, nuts and lockwashers(8). Tighten securely.

Install chain lugs (3) on either side of tractor top link mounting (5) using bolt or pin of required diameter and length. Cat I kit requires a 3/4" diameter bolt. Cat II kit requires a 1" diameter bolt. Install top end of check chains in brackets (3).

Cutting height is then set by placing proper chain link in keyhole slot. Cutting height is easily adjustable by hooking chain higher or lower in the keyholes in chain lug (3).



CAUTION For additional safety in transport, raise Cutter as high as possible without having driveline hit deck and shorten check chains as much as possible to prevent inadvertent falling in transport.

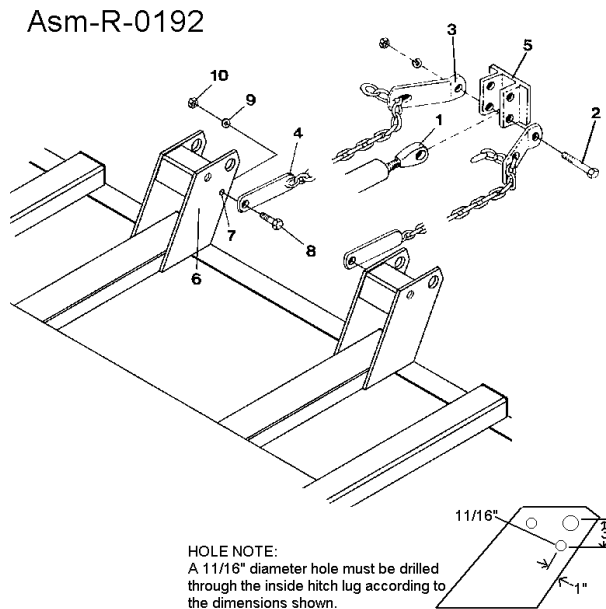

OPERATION SECTION

Operation Section 4-1

OPERATION

OPERATION

RHINO TW120 ROTARY MOWER OPERATION INSTRUCTIONS

Rhino rotary mowers are manufactured with quality material by skilled workers. These mowers are designed to cut grass, weeds, small brush and other vegetative material up to 2" diameter in areas such as pastures, industrial areas, and roadsides. The mower is equipped with protective deflectors and/or chain guards to prevent objects being thrown from the mower by the blades, however, no shielding is 100% effective. All shields, guards, deflectors, and chains equipped on the unit must be maintained on the mower in good operational condition.

It is the operator's responsibility to be knowledgeable of all potential operating hazards and to take every reasonable precaution to ensure oneself, others, animals, and property are not injured or damaged by the mower, tractor, or a thrown object. Do not operate the mower if passersby, pets, livestock, or property are within 300 feet of the unit unless:

- **All THROWN OBJECT SHIELDING** including, Front and Rear Deflectors, Chains Guards, Steel Guards, Bands, Side Skirts and Skid Shoes in place and in good condition when mowing.
- Mower sections or wing are adjusted to be close and parallel to ground without exposing blades.
- **MOWING AREA** has been inspected and foreign materials and debris have been removed.
- **PASSERSBY** are inside enclosed vehicle.

This section of the Operator's Manual is designed to familiarize, instruct, and educate safe and proper mower use to the operator. Pictures contained in this section are intended to be used as a visual aid to assist in explaining the operation of a rotary mower. Some pictures may show shields removed for purposes of clarity. **NEVER OPERATE** this implement without all shields in place and in good operational condition. The operator must be familiar with the mower and tractor operation and all associated safety practices before operating the mower and tractor. Proper operation of the mower, as detailed in this manual, will help ensure years of safe and satisfactory use of the mower.

IMPORTANT: To avoid mower damage, retorque all bolts after the first 10 hours of operation. Retighten blade carrier retaining nut on gearbox lower shaft to 600 ft. lbs.

READ AND UNDERSTAND THE ENTIRE OPERATING INSTRUCTIONS AND SAFETY SECTION OF THIS MANUAL AND THE TRACTOR MANUAL BEFORE ATTEMPTING TO USE THE TRACTOR AND IMPLEMENT. If you do not understand any of the instructions, contact your nearest authorized dealer for a full explanation. Pay close attention to all safety signs and safety messages contained in this manual and those affixed to the implement and tractor. *OPS-U- 0001*

READ, UNDERSTAND, and FOLLOW the following Safety Messages. Serious injury or death may occur unless care is taken to follow the warnings and instructions stated in the Safety Messages. Always use good common sense to avoid hazards. (SG-2)

SAFETY INSTRUCTIONS



PELIGRO

Si no lee ingles, pida ayuda a alguien que si lo lea para que le traduzca las medidas de seguridad. (SG-3)

¡ LEA EL INSTRUCTIVO!



OPERATION

1. OPERATOR REQUIREMENTS

Safe operation of the unit is the responsibility of a qualified operator. A qualified operator has read and understands the implement and tractor Operator's Manuals and is experienced in implement and tractor operation and all associated safety practices. In addition to the safety messages contained in this manual, safety signs are affixed to the implement and tractor. If any part of the operation and safe use of this equipment is not completely understood, consult an authorized dealer for a complete explanation.

If the operator cannot read the manuals for themselves or does not completely understand the operation of the equipment, it is the responsibility of the supervisor to read and explain the manuals, safety practices, and operating instructions to the operator.

Safe operation of equipment requires that the operator wear approved Personal Protective Equipment (PPE) for the job conditions when attaching, operating, servicing, and repairing the equipment. PPE is designed to provide operator protection and includes the following safety wear:

PERSONAL PROTECTIVE EQUIPMENT (PPE)

- Always Wear Safety Glasses
- Hard Hat
- Steel Toe Safety Footwear
- Gloves
- Hearing Protection
- Close Fitting Clothing
- Respirator or Filter Mask (depends on operating conditions) OPS-U- 0002

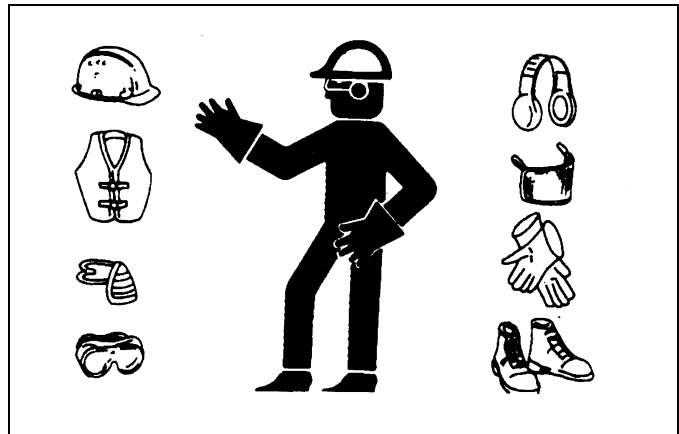

▲ DANGER

DO NOT use drugs or alcohol immediately before or while operating the Tractor and Implement. Drugs and alcohol will affect an operator's alertness and coordination and therefore affect the operator's ability to operate the equipment safely. Before operating the Tractor or Implement, an operator on prescription or over-the-counter medication must consult a medical professional regarding any side effects of the medication that would hinder their ability to operate the Equipment safely. NEVER knowingly allow anyone to operate this equipment when their alertness or coordination is impaired. Serious injury or death to the operator or others could result if the operator is under the influence of drugs or alcohol. (SG-27)

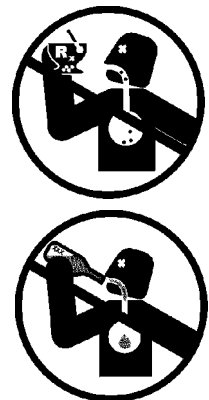

OPERATION

2. TRACTOR REQUIREMENTS

The tractor used to operate the mower must have the power capacity to lift, pull, and operate the Power Take Off (PTO) at the mower's rated speed while traveling at a ground speed between 2 and 5 MPH. Operating the mower with a tractor that does not meet the following requirements may cause tractor or mower damage and be a potential danger to the operator and passersby.

Tractor Requirements and Capabilities

- ASABE approved Roll-Over Protective Structure (ROPS) or ROPS cab and seat belt.
- Tractor Safety Devices Slow Moving Vehicle (SMV) emblem, lighting, PTO master shield
- Tractor Horsepower:
 - Minimum Lift-60 HP, Pull-50 HP & Semi-Mount-50 HP
 - Maximum 90 HP
- Drawbar Vertical Load Minimum Capacity.....1070 lbs.
- Hitch -Lift Type Mower:
 - Lifting Capacity 1818 lbs.
 - 3-Point Hitch Cat II-III & Cat 11-111 Quick Hitch
- Semi-Mount
 - 3 Point Hitch CAT II-III
 - Hydraulics..... Optional
- Pull Type Mower
 - Drawbar 14" extended length, safety chain attachment point
 - Hydraulics..... Optional
- Front End Weight As needed to maintain 20% weight on front axle
- Power Take Off..... 540 RPM 6-spline or 1000 RPM 21-spline, 1-3/8" diameter output shaft

2.1 ROPS and Seat Belt

The tractor must be equipped with a Roll-Over-Protective-Structure (ROPS) (tractor cab or roll-bar) and seat belt to protect the operator from falling off the tractor, especially during a roll over where the driver could be crushed and killed. Only operate the tractor with the ROPS in the raised position and seat belt fastened. Tractor models not equipped with a ROPS and seat belt should have these life saving features installed by an authorized dealer. *OPS-U- 0003*



Operate this Equipment only with a Tractor equipped with an approved roll-over-protective system (ROPS). Always wear seat belts. Serious injury or even death could result from falling off the tractor--particularly during a turnover when the operator could be pinned under the ROPS. (SG-7)



OPERATION

2.2 Tractor Safety Devices

If transporting or operating the tractor and implement near a public roadway, the tractor must be equipped with proper warning lighting and a Slow Moving Vehicle (SMV) emblem which are clearly visible from the rear of the unit. Lights and a SMV emblem must be equipped directly on implements if the visibility of the tractor warning signals are obscured.

Maintain all manufacturer equipped safety shields and guards. Always replace shields and guards that were removed for access to connect, service, or repair the tractor or implement. Never operate the tractor PTO with the PTO master shield missing or in the raised position. OPS-U- 0004

2.3 Tractor Horsepower

The power required to operate a mower is determined by the tractor PTO horsepower. For most mowing conditions, the TW120 lift mower requires a tractor with at least 60 HP and the semi-mount and pull type mower require at least 50 HP. Operating the mower with a tractor that does not have adequate power may damage the tractor engine. Exceeding 90 HP may cause mower damage by overpowering the unit in heavy cutting conditions.

2.4 3-Point Hitch

Lift Type Mower-The tractor 3-point hitch must be rated to lift at least 1818 lbs.

The Model TW120 is designed to be mounted on a tractor with CATII or CATIII 3-point or CATII or CATIII Quick Hitch.

Refer to the tractor operator's manual for the category of the tractor being used. If the hitch does not conform to ASABE dimensions, the mower may not fit or raise properly. Consult an authorized dealer for possible modification procedures to mount non-conforming hitches.

Depending on the hitch category, certain size pins are used to attach the mower to the tractor. Quick Hitch requires 1-7/16 diameter lower pin and 1-1/4 diameter upper pin. CATII hitches require 1-1/8 lower pins and 1 inch upper pins. CATIII hitches require 1-7/16 lower pins and 1-1/4 upper pin diameters.

Our 3-point Quick Hitch is designed to connect to a Quick-Attach coupler making mounting and dismounting your mower easier. The 3-Point Quick Hitch is also designed to connect the mower to a tractor's 3-point linkage without the use of a Quick-Attach Coupler.

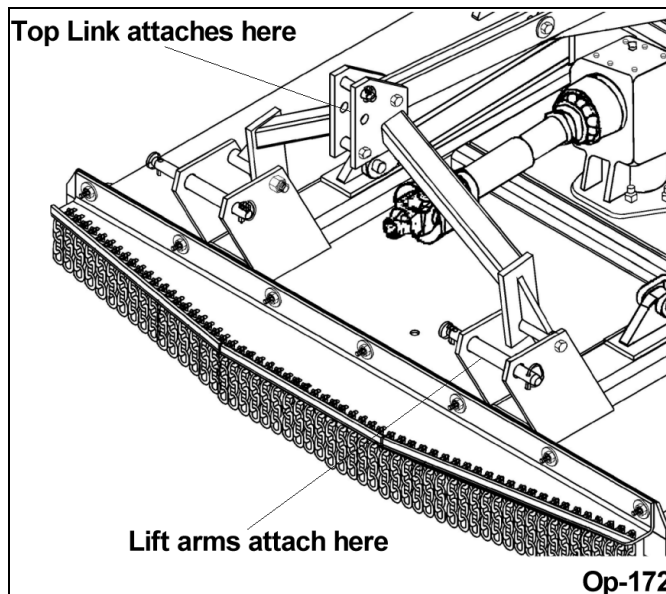

OPERATION

OPERATION

2.5 Drawbar-Pull Type Mower

For pull type mowers (540 and 1000 RPM) equipped with an equal-angle driveline, the tractor drawbar must be positioned at a 14" distance from the hitch point to the PTO shaft end for proper operation and minimal wear to the driveline and tractor.

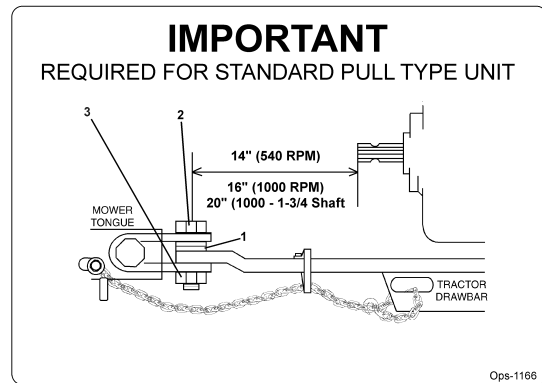

If attaching the mower tongue clevis to a 3-point hitch drawbar supported by the lower lift arms, the attaching point must be extended past the main bar to allow for turning without binding the clevis and bar. Lift arm stabilizers must be used with this type of drawbar to prevent the mower from swaying from side to side. OPS-R-0061.

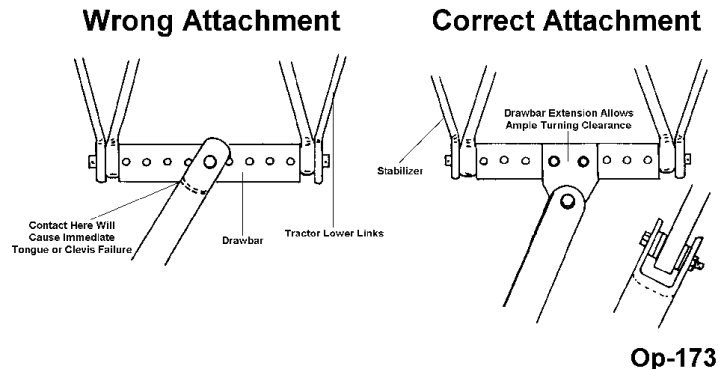

2.6 Front End Weight

A minimum of 20% total tractor weight must be maintained on the tractor front end at all times. Front end weight is critical to maintain steering control and to prevent the tractor from rearing up while driving. If the front end is too light, add weight until a minimum of 20% total weight is reached on the front tires. Front weights and weight carriers can be purchased through an authorized tractor dealership. OPS-U-0005

OPERATION

2.7 Power Take Off (PTO)

This mower is designed to operate at a PTO speed of 540. Most tractors operate at either 540, or a combination of 540 and 1000 RPM PTO speeds. The operating speed of the mower and tractor can be determined by the number of splines on the driveline yoke and PTO output shaft. Those operating at 540 RPM will have a 6-spline shaft and those operating at 1000 RPM will have a 21-spline shaft. **Note:** Only the 284 mower can be ordered to operate on tractors equipped with a 1000 RPM 21-spline shaft. Refer to the tractor owner's manual for instructions to change PTO speeds on models that operate at more than one speed.

If operating an older model tractor where the tractor's transmission and PTO utilize one master clutch, an over-running clutch must be used between the PTO output shaft and the driveline of the mower. An authorized tractor dealer can provide the over-running clutch and its installation if needed. OPS-R- 0066_A



DO NOT use a PTO adapter to attach a non-matching Implement driveline to a Tractor PTO. Use of an adapter can double the operating speed of the Implement resulting in excessive vibration, thrown objects, and blade and implement failure. Adapter use will also change the working length of the driveline exposing unshielded driveline areas. Serious bodily injury and/or equipment failure can result from using a PTO adapter. Consult an authorized dealer for assistance if the Implement driveline does not match the Tractor PTO.

(S3PT-14)



Never operate the Tractor and Mower if the Implement input driveline is directly connected to the Tractor transmission. Tractor braking distances can be substantially increased by the momentum of the rotating Mower blades driving the Tractor transmission even though the Tractor clutch has been disengaged. Install an over running clutch between the Tractor PTO and the Mower driveline to prevent this potentially dangerous situation. (S3PT-16)



Do not connect the PTO driveline to the tractor or operate the implement unless the implement is securely connected to the tractor.

2.8 Tire Spacing

Tractor tires should be set a minimum of 60" (1.5 m) apart measured from inside of tire to inside of tire. Refer to the tractor Operator's Manual or consult an authorized dealer for instructions to change tractor tire spacing. OPS-R- 0062



Op-232

OPERATION

3. GETTING ON AND OFF THE TRACTOR

Before getting onto the tractor, the operator must read and completely understand the implement and tractor operator manuals. If any part of either manual is not completely understood, consult an authorized dealer for a complete explanation. *OPS-U- 0007*



WARNING

Do not mount or dismount the Tractor while the tractor is moving. Mount the Tractor only when the Tractor and all moving parts are completely stopped. (SG-12)



3.1 Boarding the Tractor

Use both hands and equipped handrails and steps for support when boarding the tractor. Never use control levers for support when mounting the tractor. Seat yourself in the operator's seat and secure the seat belt around you.

Never allow passengers to ride on the tractor or attached equipment. Riders can easily fall off and be seriously injured or killed from falling off and being ran over. It is the operator's responsibility to forbid all extra riders at all times. *OPS-U- 0008*



DANGER

Never allow children to operate, ride on, or come close to the Tractor or Implement. Usually, 16-17 year-old children who are mature and responsible can operate the implement with adult supervision, if they have read and understand the Operator's Manuals, been trained in proper operation of the tractor and Implement, and are physically large enough to reach and operate the controls easily. (SG-11)



DANGER

Never allow children or other persons to ride on the Tractor or Implement. Falling off can result in serious injury or death. (SG-10)



3.2 Dismounting the Tractor

Before dismounting, park the tractor and implement on a reasonably level surface, apply the parking brake, idle the engine down, disengage the PTO, and lower the implement to the ground. Shut down the tractor engine according to the operator's manual, remove the key, and wait for all motion to completely stop. Never leave the seat until the tractor, its engine and all moving parts have come to a complete stop.

Use hand rails and steps when exiting the tractor. Be careful of your step and use extra caution when mud, ice, snow or other matter has accumulated on the steps or hand rails. Use all handrails and steps for support and never rush or jump off the tractor. *OPS-U- 0009*

OPERATION



BEFORE leaving the tractor seat lower the implement, set the parking brake and/or set the tractor transmission in parking gear, disengage the PTO, stop the engine, remove the key, and wait for all moving parts to stop. Place the tractor shift lever into a low range or parking gear to prevent the tractor from rolling. Never dismount a Tractor that is moving or while the engine is running. Operate the Tractor controls from the tractor seat only. (SG-9)

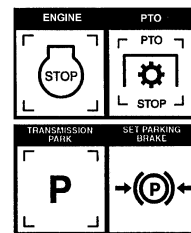

4. STARTING THE TRACTOR

The operator must have a complete understanding of the placement, function, and operational use of all tractor controls before starting the tractor. Review the tractor operator's manual and consult an authorized dealer for tractor operation instructions if needed.

Essential Tractor Controls:

- Locate the light control switch.
- Locate the engine shut off control.
- Locate the brake pedals and the clutch.
- Locate the PTO control.
- Locate the 3-point hitch control lever.
- Locate the hydraulic remote control levers.

Before starting the tractor ensure the following:

- Conduct all pre-start operation inspection and service according to the tractor operator's manual.
- Make sure all guards, shields, and other safety devices are securely in place.
- The parking brake is on.
- The PTO control lever is disengaged.
- The 3-point hitch control lever is in the lowered position.
- The hydraulic remote control levers are in the neutral position.
- The tractor transmission levers are in park or neutral.

Refer to the tractor owner's manual for tractor starting procedures. Only start the tractor while seated and belted in the tractor operator's seat. Never bypass the ignition switch by short circuiting the starter solenoid.

After the tractor engine is running, avoid accidental contact with the tractor transmission to prevent sudden and unexpected tractor movement. OPS-U-0028



Never run the Tractor engine in a closed building or without adequate ventilation. The exhaust fumes can be hazardous to your health. (SG-23)



Start tractor only when properly seated in the Tractor seat. Starting a tractor in gear can result in injury or death. Read the Tractor operators manual for proper starting instructions. (SG-13)



OPERATION

5. CONNECTING THE MOWER TO THE TRACTOR

Use extreme caution when connecting the mower to the tractor. The mower should be securely resting at ground level or setting on blocks. Keep hands and feet from under the mower deck and clear of pinch points between the tractor hitch arms and mower pins. *OPS-R-0001*



Always shut the Tractor completely down, place the transmission in park, and set the parking brake before you or anyone else attempts to connect or disconnect the Implement and Tractor hitches. (S3PT-15)

5.1 Connecting the Mower-Lift Type and Semi-Mount Type

1. Make sure the tractor is equipped with the correct PTO shaft. Change shafts if needed.
2. Shorten or remove the tractor drawbar to avoid interference when raising and lowering the mower.
3. Board the tractor and start the engine. Position the tractor to the mower with the 3-point lift arms positioned between the respective set of mower A-frame lift lugs. Note: Set the 3-point lift control to "Position Control" so that the lift arms maintain a constant height when attaching the mower. See the tractor Operator's Manual for correct settings when attaching 3-point equipment.
4. Turn off the tractor engine, set the parking brake, place the tractor in park, and dismount.
5. One lift arm at a time, align arm end hole between the set of holes of A-frame lift lugs. Insert hitch pin through the lug and arm holes and insert retaining pin into hitch pin. Walk around to opposite side and repeat procedure for remaining lift arm and hitch pin.
6. **Lift Mowers**-Extend or retract the 3-point top link to align its end hole with the holes of the mower's top link. Insert the top link hitch pin and insert retaining pin into hitch pin. Adjust any lower link check chains, guide blocks, or sway blocks to prevent the mower from swaying side to side and possible contact with tractor rear tires.



OPERATION

5.2 3-Point Quick Hitch

Our 3-Point Quick Hitch is designed to connect to a Quick-Attach Coupler making mounting and dismounting your mower easier. The 3-Point Quick Hitch is also designed to connect the cutter to a tractor's three-point linkage without the use of a Quick-Attach Coupler.



5.3 Connecting Mower - Lift Type (Quick Hitch)

WARNING

Crushing Hazard between Quick-Hitch and Implement. Do not allow anyone to stand between the Quick-Hitch and implement during hook-up operations. Never operate the hydraulic 3-point lift controls while someone is directly behind the tractor.

1. Make certain the implement's upper and lower hitch pins are secured.
2. Lower the tractor's 3-point lift until the three Quick-Hitch hooks are lower than the implement's hitch pins. Carefully back the tractor to align the Quick-Hitch hooks under the implement's hitch pins.
3. Slowly raise the tractor's 3-point lift until the lower Quick-hitch hooks lock into place over the implement's 3-point hitch pins.

IMPORTANT: Make certain the implement's top 3-point hitch pin is captured by the Quick-Hitch top 3-point hook. If not consult your Quick Hitch manual for required adjustment.

IMPORTANT: The Quick Hitch will move mower further from tractor which will require checking the following:

1. Driveline length
2. Tractor stability

NOTE: Offset Adapter Hitches are available to position the mower to the left or right. Mowers with Offset Adapter Hitches connect to the 3-point hitch the same way as the mower A-frame. See Offset Adapter Hitch in the Assembly Section for details to equip the mower with this feature.



OPERATION

5.4 Safety Tow Chain

If the mower is towed on a public roadway, a safety chain with tensile strength equal to or greater than the gross weight of the mower must be connected between the tractor and mower. This will help control the implement in the event the tongue becomes disconnected from the drawbar. Make sure the chain is attached to a secure location on the tractor and not to an intermediate support.

After connecting both ends of the safety chain, drive the tractor to the right and left to check for proper chain length. Adjust length as necessary and allow only enough slack in the chain to make a maximum turn in both directions. When not in use, store the safety chain to protect it from mud or standing water by wrapping the chain around the tongue. Replace the safety chain if one or more links or end fittings are broken, stretched or otherwise damaged or deformed. *OPS-U-0039*

5.5 Connecting the Mower-Pull Type

1. Make sure the tractor is equipped with the correct PTO shaft and the drawbar is extended 14" from the end of the PTO shaft to the hitch point.
2. Block the mower wheels in place and use the attached parking jack to raise or lower the tongue clevis to the height of the tractor drawbar. The parking jack can be rotated 15 degrees in each direction to obtain a near vertical position. Note: Always place jack foot on firm surface or place board under jack for support.
3. Board the tractor and start the engine. Back the tractor to the mower aligning the drawbar hitch hole with the mower hitch clevis. Turn off the tractor engine, set the parking brake, place the tractor in park, and dismount.
4. To attach the mower, place two 1" flatwashers (1) positioned under top lip of tongue clevis and to the top of drawbar. Add additional 1" flatwashers (2) between the bottom of drawbar and bottom lip of clevis to fill open space. Insert a 3/4" x 4-1/2" grade 5 or 8 bolt (3) through clevis and drawbar and retain in position with a 1" locknut (4). The bolt and locknut should be tightened securely to support the tongue properly without springing or breaking the clevis. Never attach mower to the tractor with a pin not having a nut.
5. Securely attach mower safety chain to tractor drawbar or drawbar support frame.
6. Lower the jack until the tongue is completely supported by the drawbar. Remove jack from the tongue and place on storage bracket of mower main frame.

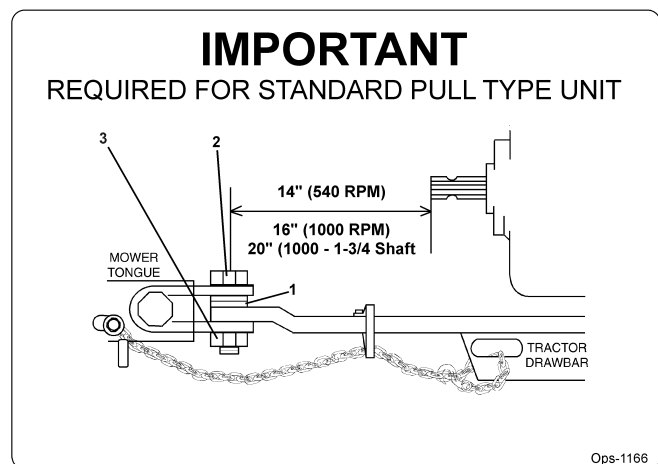
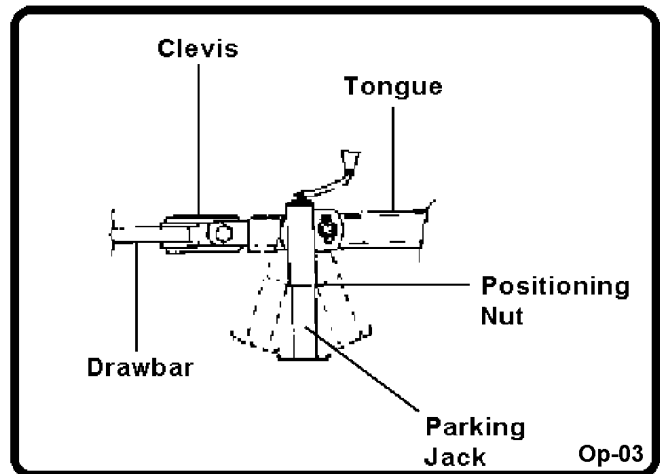

OPERATION

7. If using a hydraulic cylinder, connect hydraulic hose ends into tractor hydraulic ports.
8. If the mower has been attached to a 3-point hitch drawbar, adjust any tractor equipped lower link check chains, guide blocks, or sway blocks to prevent the hitch and mower from swaying side to side. Note: Never raise the 3-point lift with the mower attached as catastrophic driveline damage will occur.

6. SETTING THE MOWER

Properly setting the cutting height is essential for efficient and safe operation. A properly set mower will make a more uniform cut, distribute clippings more evenly, require minimal tractor work, and follow the contour of uneven terrain. **NOTE:** *Avoid very low cutting heights, striking the ground with the blades gives the most damaging shock loads and will cause damage to the mower and drive. Blades contacting the ground may cause objects to be thrown out from under the mower deck. Always avoid operating the mower at a height which causes the blades to contact the ground. OPS-U- 0010*



Never work under the Implement, the framework, or any lifted component unless the Implement is securely supported or blocked up to prevent sudden or inadvertent falling which could cause serious injury or even death. (SG-14)



6.1 Setting Mower Height- Lift Type

1. Park the tractor and mower on level ground.
2. Using the 3-point hitch control lever, position the front of the mower with its side skids 1" less off the ground than desired cut height. For example, for a 3" cut, position the skids 2" from the ground. Set the 3-point control lever stop at this position to maintain this height when raising and lowering the mower.
3. Shut down the tractor and remove the key.
4. Level the mower deck front to rear by extending or retracting the 3-point top link.

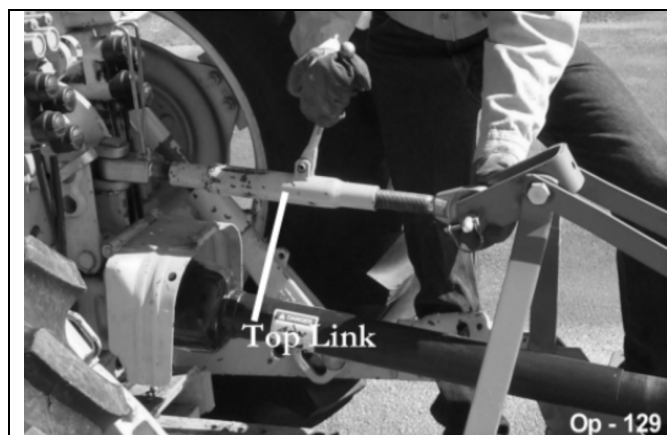

OPERATION

OPERATION

5. Level the mower side to side by manipulating one lower lift arm length. On most tractors, at least one of the lift arms is designed to allow for manipulation of its length. Shortening or extending will allow for deck leveling from side to side.
6. Securely block up the mower at this height.
7. Remove the bolts securing the tailwheel beam support brackets and allow the tailwheel(s) to rest at ground level. Align beam and positioning bracket holes with closest set of holes in support brackets and reinstall securing the beam(s) in position. Tighten all bolts and nuts.
3. Extend the tractor's top 3-point link so that when lifting the mower, the front of the deck will raise 2 to 2½" before the tail wheel(s) leaves the ground. This will allow the mower to follow the contour of uneven terrain.

Note: Install optional check chains when there is a problem with the hydraulic 3-Point lift maintaining a set height or when a constant preadjusted cut height is required. See check chains in the Assembly Section for equipping the tractor and mower with this accessory.



6.2 Setting Mowing Height-Pull Type

1. Park the tractor and mower on level ground.
2. Using the tailwheel ratchet jack or hydraulic cylinder, position the mower so the skid shoes are 1" less off the ground than the desired final cut height. For example, if a 3" cut is desired, raise or lower the mower until the skid shoes are 2" off the ground. If a hydraulic cylinder is used, stroke control spacers can be placed on the hydraulic shaft to maintain a set cutting height each time the mower is raised and lowered.
3. Adjust the mower leveling rod so that the front of the mower is approximately ¾" lower than the rear.
4. If the mower is attached to a 3-point hitch drawbar, adjust any tractor equipped lower link check chains, guide blocks, or sway blocks to prevent the hitch and mower from swaying from side to side. Never raise the 3-point lift with the mower attached as catastrophic driveline damage will occur.

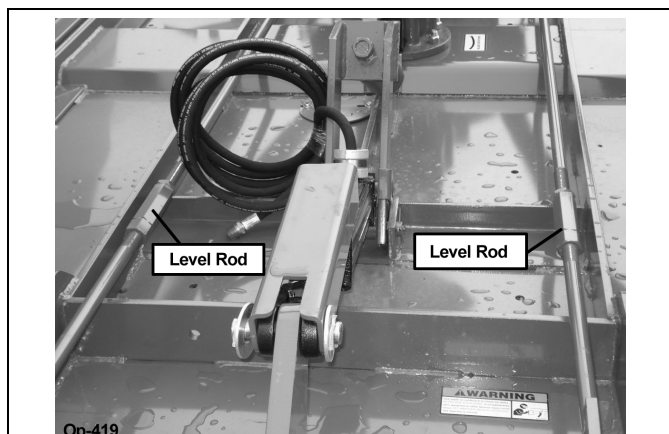

OPERATION

6.3 Setting Deck Pitch

Lower Horse Power - Better Fuel Efficiency

To increase fuel efficiency and lower horsepower requirements for mower operation, the mower should be operated with the deck approximately 3/4" LOWER IN THE FRONT THAN THE REAR. Operating the mower at this pitch will allow the mower to cut the grass only once and requires less work from the tractor.

Increase Mulching

To increase mulching of the grass or crop material during mower operation, the mower should be operated with the deck approximately 3/4" HIGHER IN THE FRONT THAN THE REAR.

Operating the mower at this pitch will allow the mower to cut the grass twice and can result in a more even cut and improved distribution of the cut material.

IMPORTANT:

Adjust the leveling rods the same amount and maintain equal tension in the rods. Improper adjustment may cause rods to snap or bend. Retighten the jamnuts after the deck pitch has been set. OPS-U-0041

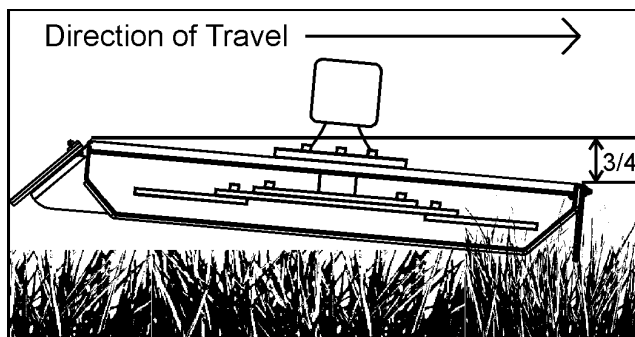

Better Fuel Efficiency

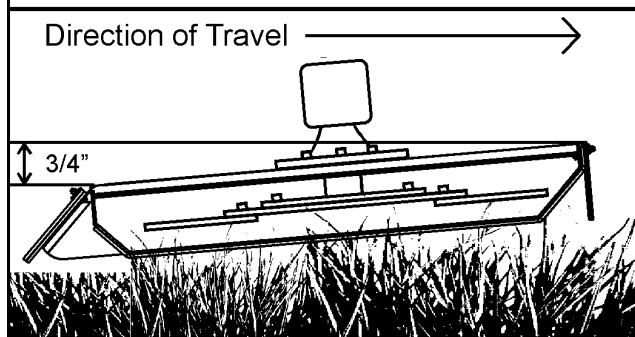

Increase Mulching

Ops-1407

7. DRIVELINE ATTACHMENT

The driveline yoke and tractor PTO shaft must be dirt free and greased for attachment.

To connect the mower driveline to the tractor PTO output shaft, pull the driveline yoke collar back and align the grooves and splines of the yoke with those of the PTO shaft. Push the driveline yoke onto the PTO shaft, release the locking collar, and position the yoke until the locking collar balls are seated onto the PTO shaft. Push and pull the driveline back and forth several times to ensure a secure attachment. OPS-R-0003_1



OPERATION

WARNING

When attaching the Implement input driveline to the Tractor PTO, it is important that the connecting yoke spring activated locking collar slides freely and the locking balls are seated securely in the groove on the Tractor PTO shaft. Push and pull the driveline back and forth several times to ensure it is securely attached. A driveline not attached correctly to the Tractor PTO shaft could come loose and result in personal injury and damage to the Implement. (S3PT-17)

7.1 Driveline Length Check

WARNING

Before operating the Implement, check to make sure the Implement input driveline will not bottom out or become disengaged. Bottoming out occurs when the inner shaft penetrates the outer housing until the assembly becomes solid-it can shorten no more. Bottoming out can cause serious damage to the Tractor PTO by pushing the PTO into the Tractor and through the support bearings or downward onto the PTO shaft, breaking it off. A broken driveline can cause personal injury. (S3PT-18)

When fitting the mower to the tractor, the telescoping driveline must be inspected to ensure that at its most compressed position, the profiles do not “bottom out”, and when at its farthest extended position, there is sufficient engagement between the profiles to operate safely. At its shortest length, there must be at least a 1” clearance between each profile end and opposite profile universal joint. At its farthest operating extension, a minimum profile engagement of 12” must be maintained.

“Bottoming Out” Check Procedure

- Disconnect driveline from the tractor and slide the profiles together until fully compressed.
- Place a mark on the inner shield 1/8” from the end of the outer shield.
- Reattach the driveline to the PTO Shaft.
- **Lift and Semi-Mount Type** - Raise the mower/
Pull Type - Turn sharply and watch the driveline as it approaches the mark. If the distance between the mark and the end of the outer shield tube becomes less than 2” at any point, the driveline must be shortened. OPS-R-0004_D

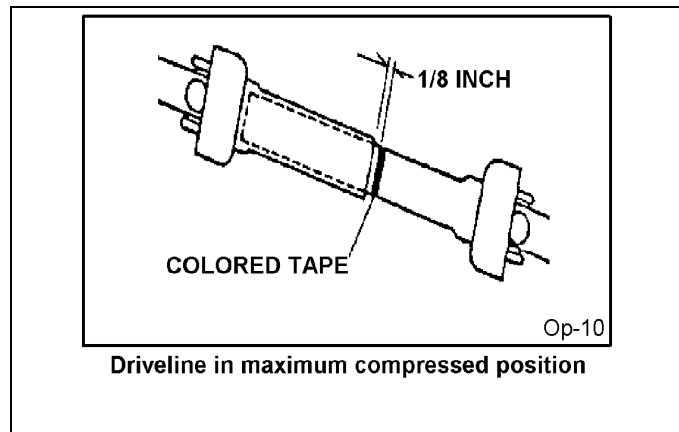

OPERATION

Shorten the driveline profiles as follows:

- Remove the driveline from the tractor.
- Position the mower (Lift and Semi-Mount Type - Raise and lower/ Pull Type - Turn sharply) to the point with the shortest distance between the tractor PTO shaft and cutter gearbox. Shut down the tractor and securely block the mower in this position.
- Pull driveline apart and reattach yoke to PTO shaft.
- Hold driveline sections parallel to one another and measure back 1" from yoke of each shaft and place mark on opposite section. Cut this length off with a saw.
- Round off all sharp edges and debur.
- Thoroughly grease then reinstall the driveline.
- Recheck for proper operation.

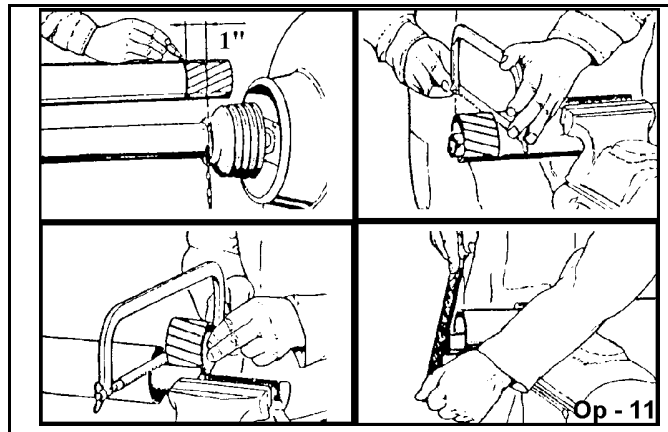

Engagement Check Procedure

- With the driveline attached, position the mower to the point where the telescoping driveline is at its maximum extension. Completely shut down the tractor and secure in position.
- Mark the inner driveline shield 1/8" from the end of the outer shield.
- Disconnect the driveline from the tractor and separate the two driveline halves.
- Measure the distance from the mark to the end of the inner profile. This length is the amount the driveline profiles were engaged.
- If the engaged length is less than 12" for a CV driveline and less than 6" for a non-CV driveline, the shaft is considered too short and should be replaced with a longer shaft. Consult an authorized dealer to purchase the required driveline length.

NOTE: When raising the mower, at least 1" clearance must be maintained between the driveline and the mower deck. If necessary, place an upper lift stop on the 3-point hitch control lever to limit the height the mower can be raised. OPS-R-0005-G

OPERATION

7.2 Constant Velocity (CV) Driveline

Mowers are equipped with a Constant Velocity (CV) driveline, the maximum turning angle between the tractor and mower must be determined to ensure the joint angle does not over-extend which can cause CV joint damage. Constant Velocity joints enable the driveline to operate smoothly with no vibrations and clattering at angles up to 80°. Angles greater than 80° will result in mechanical damage to the CV joint and mower driveline.

The Constant Velocity joint must be lubricated every 20-40 hours of operation as specified in the Maintenance Section. Failure to properly lubricate the joint will result in accelerated wear and joint component failure.

CV Driveline Maximum Angle Check Procedure

- With the **mower attached** to the tractor and the **driveline disconnected** from the tractor PTO stub make a hard left turn until there is approximately a 1" clearance between the left rear tractor tire and mower frame or tongue.
- Stop and completely shut down the tractor. Place the tractor in Park and apply the Parking Brake before dismounting.
- Check the CV joint at this maximum turning radius by holding the driveline yoke above the PTO shaft and then angle the CV joint to its maximum angle. A minimum difference of 10 degrees between the center line of the yoke and the PTO shaft must be maintained to ensure the joint will not be over angled. If the joint cannot be angled at least 10°, there is a potential problem of over-angling the joint while making sharp turns.

- Solutions: To ensure the joint is not damaged, check the following:

Check the drawbar length to ensure that it is at the proper length for the RPM speed of the mower.

Move the tractor rear tires wider apart to limit the tractor turning radius.

Position the mower at multiple angles and perform the above procedure. Determine the sharpest turning radius that maintains a safe operating angle and note this position to the operator. *OPS-R-0006_A*

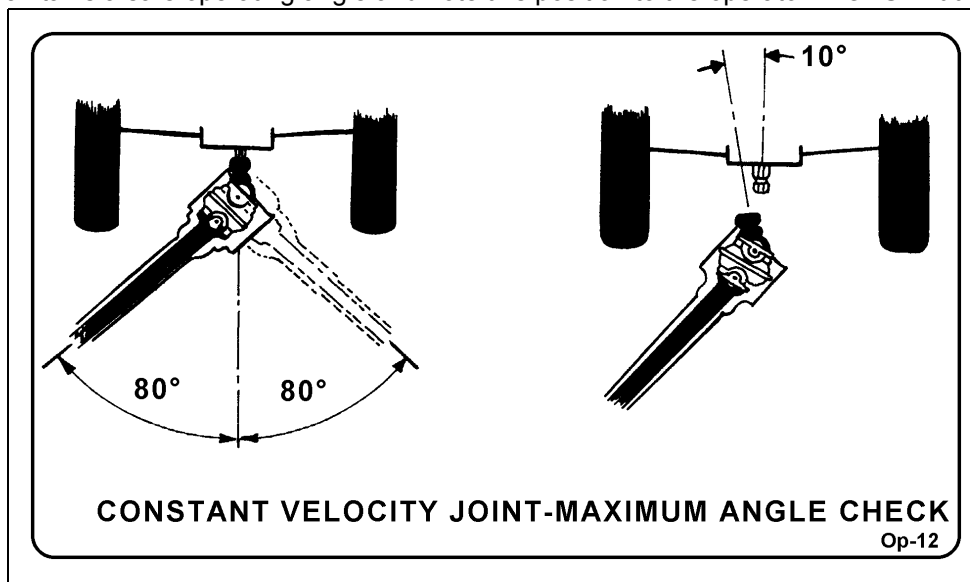

OPERATION

8. PRE-OPERATION INSPECTION AND SERVICE

Before each use, a pre-operation inspection and service of the implement and tractor must be performed. This includes routine maintenance and scheduled lubrication, inspecting that all safety devices are equipped and functional, and performing needed repairs. DO NOT operate the unit if the pre-operation inspection reveals any condition affecting safe operation. Perform repairs and replacement of damaged and missing parts as soon as noticed. By performing a thorough pre-operation inspection and service, valuable down time and repair cost can be avoided. OPS-U-0029



Always disconnect the main PTO Driveline from the Tractor before performing service on the Implement. Never work on the Implement with the tractor PTO driveline connected and running. Rotating Parts, Blades or Drivelines could turn without warning and cause immediate entanglement, injury or death. (S3PT-11)



Never work under the Implement, the framework, or any lifted component unless the Implement is securely supported or blocked up to prevent sudden or inadvertent falling which could cause serious injury or even death. (SG-14)

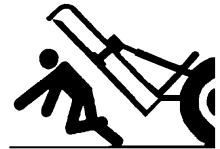

Periodically inspect all moving parts for wear and replace when necessary with authorized service parts. Look for loose fasteners, worn or broken parts, and leaky or loose fittings. Make sure all pins have cotter pins and washers. Serious injury may occur from not maintaining this machine in good working order. (SG-21)

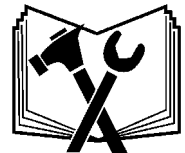

OPERATION

⚠ WARNING	⚠ ADVERTENCIA
<p>Non-genuine parts can fail catastrophically. TO AVOID SERIOUS INJURY OR DEATH:</p> <ul style="list-style-type: none"> ● ONLY use genuine RHINO replacement parts. ● Non-genuine parts can fail creating hazardous conditions for operator and bystanders. <p>Contact local dealer or RHINO about repair parts at:</p> <p>1020 S. Sangamon Ave., Gibson City, IL 60936 Customer Service: 800-446-5158 Email: parts@servis-rhino.com</p> <p style="text-align: right;">00760657_A</p>	<p>Partes que no son auténticas pueden fallar catastróficamente. PARA EVITAR LESION SERIA O MUERTE:</p> <ul style="list-style-type: none"> ● Use SOLAMENTE las partes de reemplazo auténticas de RHINO. ● Partes que no son auténticas pueden fallar y causar condiciones peligrosas para el operador y personas presentes. <p>Contacte a su distribuidor local o RHINO sobre partes de reparo a:</p> <p>1020 S. Sangamon Ave., Gibson City, IL 60936 Servicio al Cliente: 800-446-5158 Correo Electronico: parts@servis-rhino.com</p>
IMPORTANT	IMPORTANTE
<p>BE AWARE BE ALERT BE ALIVE</p>	<p>BE TRAINED Before Operating this Mower</p>
<p>ESTE CONSCIENTE ESTE ALERTO ESTE VIVO</p>	<p>SEA ENTRENADO Antes de Funcionar Cortacésped</p>
<p>To prevent serious injury to yourself and/or bystanders, be trained in Safe Mowing Practices.</p> <p>Alamo Group Companies, Alamo Industrial, Bush Hog, M&W, Rhino, Schulte and Tiger as well as AEM and FEMA provide training material that is critical for your Safety and the Safety of others when operating this equipment. Make these Safety Procedures an important part of every workday.</p> <p>Read and understand the Operator's Manual.</p> <p>Do not let untrained individuals operate this equipment.</p> <p>Contact your Dealer, AEM (www.aem.org), FEMA (314-878-2304, www.FarmEquipment.org), or Alamo Group (www.Alamo-Group.com) for information on training material or courses that provide training in Safer Operating Practices for Mowers.</p>	<p>Para prevenir lesiones graves a usted y/o personas presentes, sea entrenado en la Practica de Segar Seguro.</p> <p>Compañias de Alamo Group, Alamo Industrial, Bush Hog, M&W, Rhino, Schulte y Tiger asi como AEM y FEMA proporcionan material para entrenar que es esencial para su seguridad y la seguridad de otros al operar este equipo. Haga estos procedimientos de seguridad una parte importante de su dia de trabajo.</p> <p>Lea y entienda el Manual de Operadores.</p> <p>No permita que personas sin entrenamiento funcionen este equipo.</p> <p>Contacte a su distribuidor, AEM (www.aem.org), FEMA (314-878-2304, www.FarmEquipment.org), o Alamo Group (www.Alamo-Group.com) para la informacion sobre el material de entrenamiento o cursos que ofrecen el entrenamiento de Practicas de Operación para Cortadoras.</p> <p style="text-align: right;">00760657_B 00760657</p>

8.1 Tractor Pre-Operation Inspection/Service

Refer to the tractor operator's manual to ensure a complete pre-operation inspection and scheduled service is performed according to the manufacturers recommendations. The following are some of the items that require daily service and inspection:

- Tire condition/air pressure
- Wheel lug bolts
- Steering linkage
- PTO shield
- SMV sign is clean and visible
- Tractor's lights are clean and functional
- Tractor Seat belt is in good condition
- Tractor ROPS is in good condition
- ROPS is in the raised position
- No tractor oil leaks
- Radiator free of debris
- Engine oil level and condition
- Engine coolant level and condition
- Power brake fluid level
- Power steering fluid level
- Fuel condition and level
- Sufficient lubrication at all lube points
- Air filter condition OPS-U-0030



OPERATION

8.2 Mower Pre-Operation Inspection/Service

Before each mower use, a complete inspection and service is required to ensure the mower is in a good and safe working condition. Damaged and/or broken parts should be repaired and/or replaced immediately. To ensure the mower is ready for operation, conduct the following. *OPS-R-0007*

The operator's manual and safety signs affixed on the unit contain important instructions on the safe and proper use of the equipment. Maintain these important safety features on the implement in good condition to ensure the information is available to the operator at all times.



- Ensure the manual canister is secured to the equipment with the operator's manual inside.
- Ensure all safety signs are in place and legible. Replace missing, damaged, and illegible decals. *OPS-U-0011*

- Perform scheduled lubrication as detailed in the maintenance section.
- Ensure all decals are in place and legible.
- Ensure the driveline is securely attached to tractor. Make sure the driveline yoke locking collar is securely seated in the grooves of the PTO shaft by pushing and pulling the yoke several times.
- Lift and Semi-Mount Type-Inspect that the 3-point hitch pins are the proper size, correctly installed, and secured to the tractor lift arms with retaining pins inserted.
- Pull Type-Inspect that the hitch bolt is the correct size, that washers are inserted between the drawbar and hitch clevis, and the locknut is securely tightened. *OPS-R-0008_F*



- Ensure deflectors and/or chainguards are in position and not damaged. Replace worn, broken, and missing pieces. *OPS-R-0038*



OPERATION

⚠ DANGER

All Safety Shields, Guards and Safety devices including (but not limited to) - the Deflectors, Chain Guards, Steel Guards, Gearbox Shields, PTO integral shields, and Retractable Door Shields should be used and maintained in good working condition. All safety devices should be inspected carefully at least daily for missing or broken components. Missing, broken, or worn items must be replaced at once to reduce the possibility of injury or death from thrown objects, entanglement, or blade contact. (SGM-3)

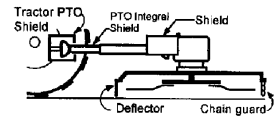

OPERATION

- Lift Type-Ensure the tailwheel beam position support bolts are properly installed and tightened.
- Pull and Semi-Mount Type-Ensure that the tailwheel ratchet or hydraulic cylinder is installed and retained correctly to provide the desired cutting height.
- Inspect all bolts and screws and tighten to the recommended torque. *OPS-R-0039_D*



- Ensure the tractor PTO master shield and the mower slip clutch shield are in place, lowered, and in good condition.
- Ensure the driveline integral shield is in good condition and rotates freely.
- Ensure the driveline slip clutch (if equipped) is properly adjusted. *OPS-R-0039*



OPERATION

- Inspect the gearbox oil level. A low oil level is a warning sign that the gearbox may be cracked or its seal is damaged and needs replacement.
- Ensure the gearbox vent is in place and free from clogs. *OPS-R-0040_C*



- Inspect blades and blade bolts for looseness and excessive wear. Make sure the mower is securely blocked up before crawling beneath. Replace damaged, worn and missing blades as complete sets to maintain rotary balance during operation.
- Ensure carrier hub nut is tightened with the cotter pin inserted and spread.
- Ensure the blade carriers are properly timed to avoid blade contact during operation. See instructions to properly time blades in the Maintenance Section. *OPS-R-0041_B*



- Ensure each hydraulic cylinder is installed and retained correctly. Ensure the proper size pins are used to retain the cylinders in place and are secured with pins.
- Check for hydraulic oil leaks on the cylinders, along the hydraulic lines, and at tractor hydraulic ports. **IMPORTANT:** DO NOT use your hands to check for oil leaks. Use a piece of heavy paper or cardboard to check for hydraulic oil leaks. *OPS-R-0013_H*



OPERATION

OPERATION

8.3 Cutting Component Inspection

Inspect blade pan and blade assembly for the following:

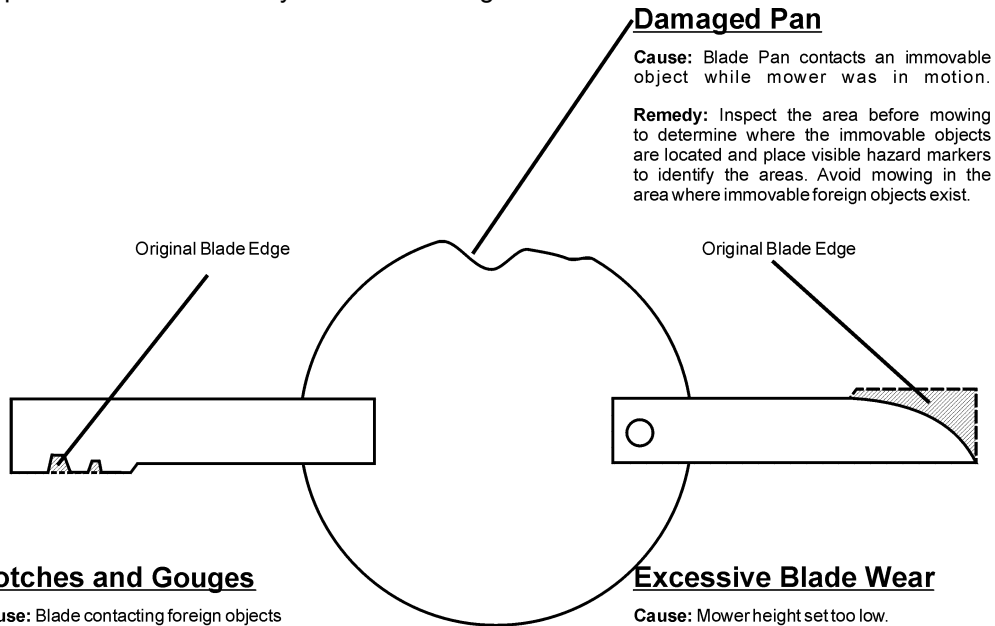

Damaged Pan

Cause: Blade Pan contacts an immovable object while mower was in motion.

Remedy: Inspect the area before mowing to determine where the immovable objects are located and place visible hazard markers to identify the areas. Avoid mowing in the area where immovable foreign objects exist.

Notches and Gouges

Cause: Blade contacting foreign objects

Remedy: Inspect the area to be mowed and remove foreign objects that could cause damage to the blades

Excessive Blade Wear

Cause: Mower height set too low. Blade used past intended life.

Remedy: Replace blades more often. Adjust mower height for mowing Conditions to eliminate blade-to-ground contact

Op-22

OPS-U-0031

Check Output Shaft Nut Torque.
Maintain 600-ft-lbs.

Check Blade Bolt Torque.
Torque to 600 ft-lbs.

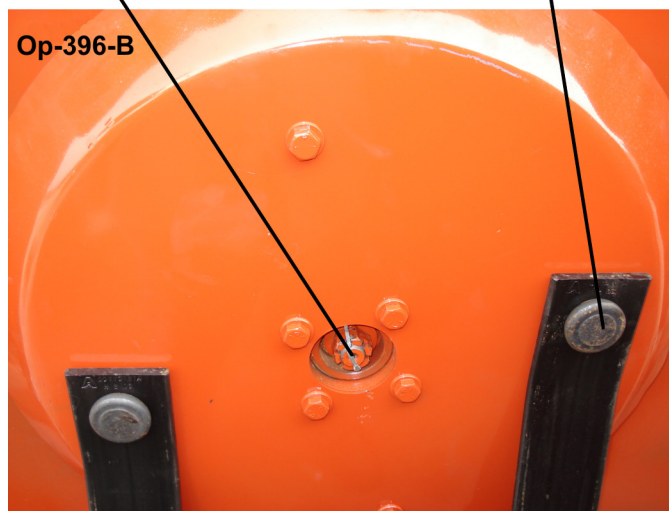

OPERATION

WARNING

Operating the mower with loose blade hardware will damage the blade holder or blades and can result in blade breakage or blade fastener failure. Broken blades or bolts can be thrown out from under the mower for distances up to 300 feet. When the blades are replaced, the fastening hardware must be replaced. Check and retighten the blade hardware after the first eight hours of operation. In severe cutting conditions, recheck the blade carrier and blade bolt torque every 50 hours.

Important

To help prevent structural damage caused by loose hardware, tighten gearbox mounting hardware as specified. Check the fastener torque after first 8 hours of use and every 50 hours thereafter.



DANGER

Inspect the Blades daily for abnormal wear. REPLACE BOTH BLADES on that carrier IMMEDIATELY if either blade has:

- Become bent or deformed from it's original shape or
- Any cracks are visible, or
- Deep gouges in the blade's surface are present, or
- Gouges or chipped areas in the cutting edge are larger than 1/2"(12.7mm), or
- The material on the leading edge has been worn away by more than 1/2(12.7mm)"

Failure to replace abnormally worn blades may lead to catastrophic failure of the blades and ejection of the broken part with tremendous force which may cause serious bodily injury or death. OPS-U-0032

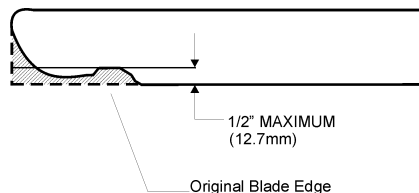

NOTE:
Replace Blades in pairs after no more than 1/2" (12.7mm) wear
Op-23

OPERATION

OPERATION

8.4 Blade Bolt Inspection

Inspect Blade Bolt Head daily for wear as followed:

Excessive Blade Bolt Wear

Cause: Blade Bolt contacts a foreign or solid object while Blade is in motion.

Remedy: Inspect the area before mowing to determine where the foreign objects are located and place visible hazard markers to identify the areas where immovable foreign objects exist, and avoid hitting the objects.

Notches and Gouges

Cause: Blade Bolt contacting foreign objects.

Remedy: Inspect area to be mowed and remove foreign objects that could cause damage to the blade bolt.

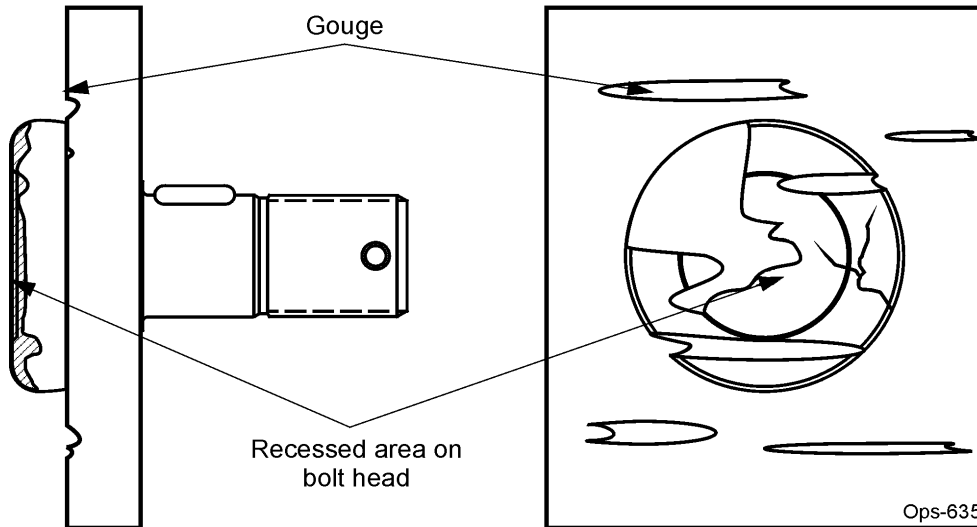

⚠ DANGER

Inspect the Blade Bolt Heads daily for abnormal wear. REPLACE BOTH BLADE BOLTS on the Blades IMMEDIATELY if either blade bolts has:

- Visible cracks or
- If the recessed area on blade bolt is worn off or
- If Blade Bolt has gouges or chipped areas.

Failure to replace abnormally worn blade bolts may lead to catastrophic failure of the blades and ejection of the broken part which may cause serious bodily injury or death.

Always replace Blade Bolts with new bolts whenever replacing the Blades. OPS-U-0037

OPERATION

Tractor PRE-OPERATION Inspection



Tractor ID# _____ Make _____

Date: _____ Shift _____



Before conducting the inspection, make sure the tractor engine is off, all rotation has stopped and the tractor is in park with the parking brake engaged. Make sure the mower is resting on the ground or securely blocked up and all hydraulic pressure has been relieved.

OPERATION

Item	Condition at Start of Shift	Specific Comments if not O.K.
The flashing lights function properly		
The SMV Sign is clean and visible		
The tires are in good condition with proper pressure		
The wheel lug bolts are tight		
The tractor brakes are in good condition		
The steering linkage is in good condition		
There are no visible oil leaks		
The hydraulic controls function properly		
The ROPS or ROBS Cab is in good condition		
The seatbelt is in place and in good condition		
The 3-point hitch is in good condition		
The drawbar pins are securely in place		
The PTO master shield is in place		
The engine oil level is full		
The brake fluid level is full		
The power steering fluid level is full		
The fuel level is adequate		
The engine coolant fluid level is full		
The radiator is free of debris		
The air filter is in good condition		

Operator's Signature: _____

DO NOT OPERATE an UNSAFE TRACTOR or MOWER

OPERATION

Rotary Mower PRE-OPERATION Inspection



Mower ID# _____ Make _____

Date: _____ Shift _____



Before conducting the inspection, make sure the tractor engine is off, all rotation has stopped and the tractor is in park with the parking brake engaged. Make sure the mower is resting on the ground or securely blocked up and all hydraulic pressure has been relieved.

OPERATION

Item	Condition at Start of Shift	Specific Comments if not O.K.
The Operator's Manual is in the canister on the mower		
All safety decals are in place and legible		
The tongue/hitch connection bolts & pins are tight		
There are no cracks in tongue or hitch		
The tow chain is secured to the tractor & mower		
The hydraulic cylinders pins are tight		
There are no leaking or damaged hoses		
The mower deck is clear of cut grass and debris		
Chain guards/deflectors are in place & in good condition		
Driveline/gearbox shields are in good condition		
Driveline clutches are in good condition; not frozen		
Driveline telescoping members & U-joints are lubricated		
Driveline yokes are securely attached to PTO & mower		
Gearbox mounting bolts are tight		
Gearbox oil is at the proper level		
Blade carrier retaining nut is tight		
Blades are not chipped, cracked or bent		
Blade bolts are tight		
Wheel lug nuts are tight		
Transport locks are in good condition		

Operator's Signature: _____

DO NOT OPERATE an UNSAFE TRACTOR or MOWER

OPERATION

9. DRIVING THE TRACTOR AND IMPLEMENT

Safe tractor transport requires the operator possess a thorough knowledge of the model being operated and precautions to take while driving with an attached implement. Ensure the tractor has the capacity to handle the weight of the implement and the tractor operating controls are set for safe transport. To ensure safety while driving the tractor with an attached implement, review the following. *OPS-U- 0012*



Never run the Tractor engine in a closed building or without adequate ventilation. The exhaust fumes can be hazardous to your health. (SG-23)



Transport only at speeds where you can maintain control of the equipment. Serious accidents and injuries can result from operating this equipment at high speeds. Understand the Tractor and Implement and how it handles before transporting on streets and highways. Make sure the Tractor steering and brakes are in good condition and operate properly.



Before transporting the Tractor and Implement, determine the proper transport speeds for you and the equipment. Make sure you abide by the following rules:

Test the tractor at a slow speed and increase the speed slowly. Apply the Brakes smoothly to determine the stopping characteristics of the Tractor and Implement. As you increase the speed of the Tractor the stopping distance increases. Determine the maximum transport speed not to exceed 20 mph (30 kph) for transporting this equipment.

Test the equipment at a slow speed in turns. Increase the speed through the turn only after you determine that the equipment can be operated at a higher speed. Use extreme care and reduce your speed when turning sharply to prevent the tractor and implement from turning over. Determine the maximum turning speed for you and this equipment before operating on roads or uneven ground.

Only transport the Tractor and Implement at the speeds which allow you to properly control the equipment.

Be aware of the operating conditions. Do not operate the Tractor with weak or faulty brakes or worn tires. When operating down a hill or on wet or rain slick roads, the braking distance increases: use extreme care and reduce your speed. When operating in traffic always use the Tractor's flashing warning lights and reduce your speed. Be aware of traffic around you and watch out for the other guy. (SG-19)



OPERATION

9.1 Starting the Tractor

The procedure to start the tractor is model specific. Refer to the tractor operator's manual for starting procedures for your particular tractor. Consult an authorized dealer if the starting procedure is unclear. Ensure the 3-point control lever is in the lowered position and the PTO is disengaged before starting the tractor. OPS-U-0033



9.2 Brake and Differential Lock Setting

Make sure the tractor brakes are in good operating condition. Tractor brakes can be set to operate independently allowing single rear wheel braking action or locked together to provide simultaneous rear wheel braking. FOR MOST DRIVING AND OPERATING CONDITIONS, THE BRAKE PEDALS SHOULD BE LOCKED TOGETHER TO PROVIDE THE MOST EFFECTIVE BRAKING ACTION.

Always disengage the tractor differential lock when turning. When engaged the differential lock will prevent or limit the tractor from turning. During normal cutting conditions, locking the differential provides no benefit and should not be used. OPS-U-0013

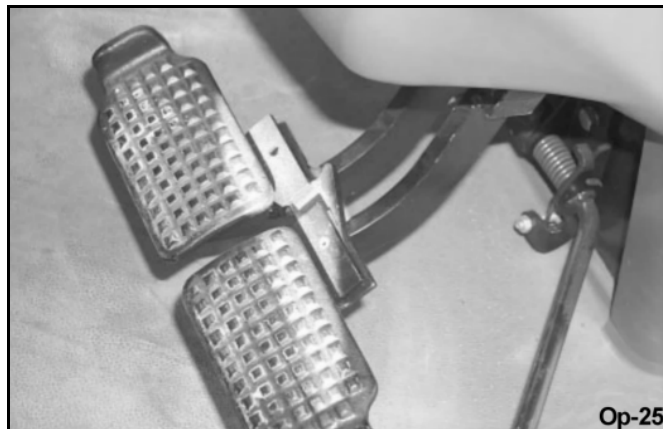

WARNING

Be aware of the operating conditions. Do not operate the Tractor with weak or faulty brakes. When operating down a hill or on wet or rain slick roads, the braking distance increases; use extreme care and reduce your speed in these conditions. When operating in traffic, always use the Tractor's flashing warning lights and reduce your speed. Be aware of traffic around you and watch out for the other guy.

OPERATION

9.3 Raising the Mower

Using the tractor 3-point hitch control lever-lift type or hydraulic remote lever-pull and semi-mount type, raise the mower high enough to clear all ground obstacles. When raising the mower, make sure all connection points are securely attached and at least 1" clearance is maintained between the driveline and the deck. If necessary, place an upper lift stop on the 3-point hitch control lever to limit the height the mower can be raised to avoid driveline damage. OPS-R-0042_A

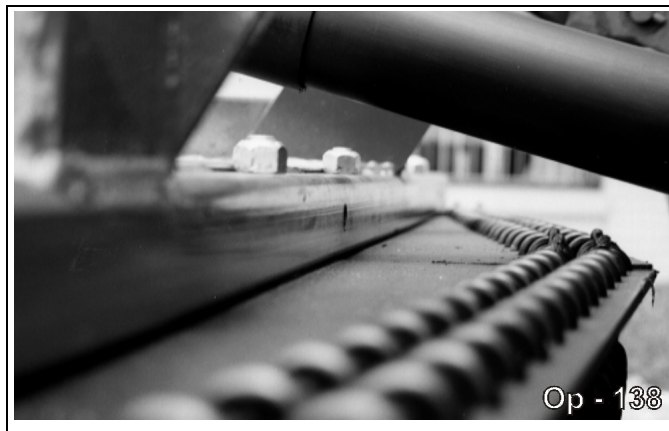

9.4 Driving the Tractor and Mower

Start off driving at a slow speed and gradually increase your speed while maintaining complete control of the tractor and mower. Moving slowly at first will also prevent the tractor from rearing up and loss of steering control. The tractor should never be operated at speeds that cannot be safely handled or which will prevent the operator from stopping quickly during an emergency. If the power steering or engine ceases operating, stop the tractor immediately as the tractor will be difficult to control.

Perform turns with the tractor and mower at slow speeds to determine how the tractor with an attached mower handles a turn. Determine the safe speed to maintain proper control of the tractor when making turns. When turning with a towed implement, the overall working length of the unit is increased. Allow additional clearance for the mower when turning.

To avoid overturns, drive the tractor with care and at safe speeds, especially when operating over rough ground, crossing ditches or slopes, and turning corners. Tractor wheel tread spacing should be increased when working on inclines or rough ground to reduce the possibility of tipping.

Use extreme caution when operating on steep slopes. Keep the tractor in a low gear when going downhill. DO NOT coast or free-wheel downhill. OPS-R-0019



OPERATION

9.5 Crossing Ditches and Steep Inclines

When crossing ditches with steep banks or going up sharp inclines, it is possible that the main driveline inner profile will penetrate into the outer housing to its maximum depth until the assembly becomes solid (driveline is at its extreme shortest length). This type of abusive operation can cause serious damage to the tractor and mower drive by pushing the PTO into the tractor and through the support bearings or downward onto the PTO shaft, breaking it off.

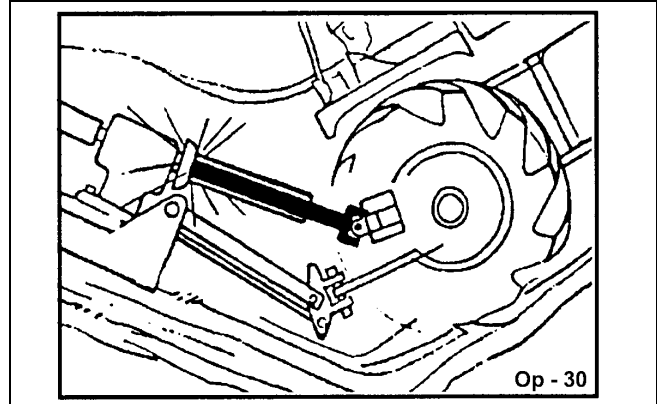

WARNING

Damage resulting from over-collapse of the driveline's inner profile and its outer housing may allow the driveline to come loose from the Tractor which could cause bodily injury to the operator or bystanders and/or extensive damage to the Tractor or Implement. OPS-R-0020

When confronted with an incline or ditch, do not approach from an angle which is perpendicular or straight on as damage to or over-collapse of the driveline may occur. OPS-R-0021_A

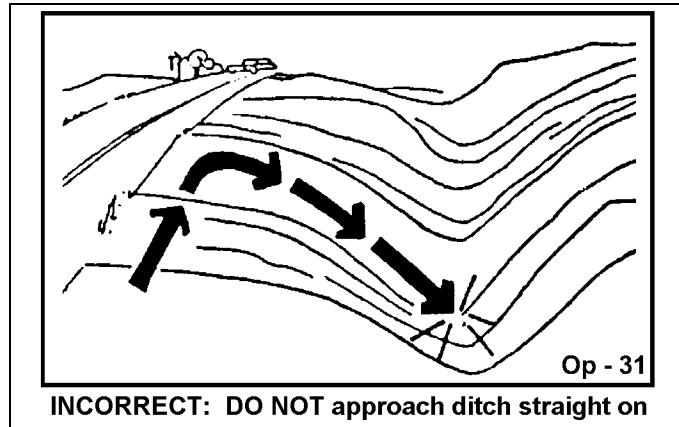

OPERATION

Inclines and ditches should be approached along a line which is at an angle as shown. This type of path will reduce the possibility of over-collapse of the driveline and resulting damage. If the gradient is so steep that such an approach increases the possibility of a tractor roll-over, select an alternate crossing path.

When operating the tractor and mower across slopes and inclines, through ditches, and other uneven terrain conditions, it is important to maintain sufficient deck to ground clearance. Blade contact with the ground may cause soil, rocks and other debris to be thrown out from under the mower resulting in possible injury and/or property damage. Ground contact also produces a severe shock load on the mower drive and to the mower blades resulting in possible damage and premature wear.
OPS-R-0022

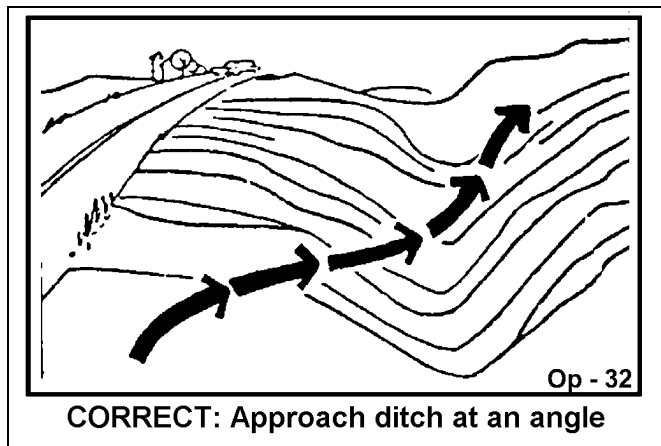

OPERATION

10. OPERATING THE TRACTOR AND IMPLEMENT

THE OPERATOR MUST COMPLETELY UNDERSTAND HOW TO OPERATE THE TRACTOR AND IMPLEMENT AND ALL CONTROLS BEFORE ATTEMPTING TO OPERATE. The operator must read and understand the Safety and Operation Sections of the implement and tractor operator's manuals. These manuals must be read and explained to any operator who cannot read. Never allow someone to operate the implement and tractor without complete operating instructions.

Before starting any operation, the operator must become familiar with the area to be worked in and any obstacles and hazards contained within to ensure safety to the operator, bystanders, and equipment. Special attention should be paid to foreign debris, rough terrain, steep slopes, and passersby and animals in the area.
OPS-U- 0015



Extreme care should be taken when operating near loose objects such as gravel, rocks, wire, and other debris. Inspect the area before mowing. Foreign objects should be removed from the site to prevent machine damage and/or bodily injury or even death. Any objects that cannot be removed must be clearly marked and carefully avoided by the operator. Stop mowing immediately if blades strike a foreign object. Repair all damage and make certain rotor or blade carrier is balanced before resuming mowing. (SGM-05)



OPERATION

WARNING

Many varied objects, such as wire, cable, rope, or chains, can become entangled in the operating parts of the mower head. These items could then swing outside the housing at greater velocities than the blades. Such a situation is extremely hazardous and could result in serious injury or even death. Inspect the cutting area for such objects before mowing. Remove any like object from the site. Never allow the cutting blades to contact such items.

(SGM-06)

10.1 Foreign Debris Hazards

Before mowing, inspect the area to make sure there are no foreign objects that the mower blades could hit or become entangled with. Remove all foreign objects and debris. If objects are too big to remove, mark them clearly and be sure to prevent the mower blades from contacting them.

If you hit a solid object or foreign debris, stop the mower and tractor at once. Immediately idle the engine speed and disengage the PTO. Wait for all mower rotating motion to stop, then raise the mower and move the tractor and implement off the object. Inspect the area and remove, or mark the location of the debris. Inspect the condition of the mower and make any needed repairs immediately. Make sure the blades are not damaged and the carrier is balanced before resuming operation.

Always wear your seat belt securely fastened and only operate the tractor and mower with the ROPS in the raised position. If the tractor or mower hits a tree stump, rock, or bump, a sudden movement could throw you off of the seat and under the tractor and/or mower. The seat belt is your best protection from falling off the tractor and the ROPS provides protection from being crushed during a tractor roll-over. *OPS-R-0023*



Remove Foreign Material



Raise Mower over solid objects

10.2 Bystanders/Passersby Precautions

If a bystander comes within 300 feet of the tractor while the mower is being operated, stop the tractor at once, idle the engine and disengage the PTO. Do not engage the PTO again until all bystanders are well past the 300 foot distance. *OPS-R-0024*

OPERATION



Rotary Mowers are capable under adverse conditions of throwing objects for great distances (300 feet or more) and causing serious injury or death. Follow safety messages carefully.



STOP MOWING IF PASSERSBY ARE WITHIN 300 Feet UNLESS:

- Front and Rear Deflectors, Chain Guards, or Bands are installed and in good, workable condition;
- Mower sections or Wings are running close to and parallel to the ground without exposed Blades;
- Passersby are outside the existing thrown-object zone;
- All areas have been thoroughly inspected and all foreign material such as rocks, cans, glass, and general debris has been removed.

NOTE: *Where there are grass and weeds high enough to hide debris that could be struck by the blades, the area should be: inspected and large debris removed, mowed at an intermediate height, inspected, closely with any remaining debris being removed, and mowed again at desired final height. (This will also reduce power required to mow, reduce wear and tear on the Mower drivetrain, spread cut material better, reduce streaking, and make the final cut more uniform).* (SRM-01)

10.3 Engaging the Power Take Off (PTO)

Before engaging the PTO, make certain that the area is clear of bystanders and passersby. The implement must be completely lowered and the deck positioned at a safe operating height. NEVER engage the PTO with the implement in the raised position.

Set the tractor engine speed at approximately 1,000 RPM before engaging the PTO. Shift the PTO control to the on position, and slowly increase the engine speed until the PTO is operating at the rated speed. If you hear unusual noises or see or feel abnormal vibrations, disengage the PTO immediately. Inspect the implement to determine the cause of the noise or vibration and repair the abnormality. OPS-U- 0027



Do not let the Blades turn when the Mower Deck is raised for any reason, including clearance or for turning. Raising the Mower deck exposes the Cutting Blades which creates a potentially serious hazard and could cause serious injury or even death from objects thrown from the Blades. (SRM-07)



Do not put hands or feet under mower decks. Blade Contact can result in serious injury or even death. Stay away until all motion has stopped and the decks are securely blocked up. (SGM-09)

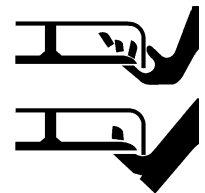

OPERATION

10.4 PTO RPM and Ground Speed

Ground speed for mowing will depend upon the height, type, and density of vegetation to be cut. Recommended speed for efficient mower performance is between 2 and 5 mph(3-8 kph). Operate the mower at its full rated PTO speed to maintain blade speed for a clean cut. Refer to the tractor operator's manual or the tractor instrument panel for the engine speed and gear to provide the required PTO and desired ground speed. Make sure that the mower is operating at its full rated speed before entering the vegetation to be cut. If it becomes necessary to temporarily regulate engine speed, increase or decrease the throttle gradually.

Ground speed is achieved by transmission gear selection and not by the engine operating speed. The operator may be required to experiment with several gear range combinations to determine the best gear and range which provides the most ideal performance from the mower and most efficient tractor operation. As the severity of cutting conditions increase, the ground speed should be decreased by selecting a lower gear to maintain the proper operating PTO speed. *OPS-R-0025*



Do not exceed the rated PTO speed for the Implement. Excessive PTO speeds can cause Implement driveline or blade failures resulting in serious injury or death. (SG-26)



Mow at the speed that you can safely operate and control the tractor and mower. The correct mowing speed depends on terrain condition and grass type, density, and height of cut. Normal ground speed range is from 2 to 5 mph(3-8 kph). Use slow mowing speeds when operating on or near steep slopes, ditches, drop-offs, overhead obstructions, power lines, or when debris and foreign objects are to be avoided. (SGM-07)

10.5 Operating the Mower

The mower is designed to cut vegetative material up to 2" in diameter. Travel at a speed that allows the mower sufficient time to cut through the vegetation and maintain the operating speed at 540 rpm to prevent overloading the mower and tractor and to produce a clean cut. Choose a driving pattern that provides the maximum pass length and minimizes turning. Remember, sharp blades produce cleaner cuts and require less power.

Under certain conditions, tractor tires may roll some grasses down preventing them from being cut at the same height as the surrounding area. When this occurs, reduce the tractor ground speed while maintaining the operating speed of the mower. A slower ground speed will permit grasses to at least partially rebound and be cut. Taking a partial cut and/or reversing the direction of travel may also help produce a cleaner cut.

Avoid mowing in the reverse direction when possible. In situations where the mower must be backed to access areas to be cut, make sure there are no persons or other foreign debris behind the mower before mowing in reverse. When mowing in reverse, operate the tractor and mower at a much reduced ground speed to ensure control is maintained of the tractor and cutter. *OPS-R-0026_H*

OPERATION

WARNING

Do not mow with two machines in the same area except with Cab tractors with the windows closed. (SGM-11)

WARNING

Mow only in conditions where you have clear visibility in daylight or with adequate artificial lighting. Never mow in darkness or foggy conditions where you cannot clearly see at least 300 feet (90 m) in front and to the sides of the tractor and mower. Make sure that you can clearly see and identify passersby, steep slopes, ditches, drop-offs, overhead obstructions, power lines, debris and foreign objects. If you are unable to clearly see these type of items discontinue mowing. (SGM-1)

WARNING

Avoid mowing in reverse direction when possible. Check to make sure there are no persons behind the mower and use extreme care when mowing in reverse. Mow only at a slow ground speed where you can safely operate and control the tractor and mower. Never mow an area that you have not inspected and removed debris or foreign material. (SGM-08)

WARNING

Follow these guidelines to reduce the risk of equipment and grass fires while operating, servicing, and repairing the Mower and Tractor:



- Equip the Tractor with a fire extinguisher in an accesible location.
- Do Not operate the Mower on a Tractor with an underframe exhaust.
- Do Not smoke or have an open flame near the Mower and Tractor.
- Do Not drive into burning debris or freshly burnt areas.
- Ensure slip clutches are properly adjusted to prevent excessive slippage and plate heating.
- Never allow clippings or debris to collect near drivelines, slip clutches, and gearboxes. Periodically shut down the Tractor and Mower and clean clippings and collected debris from the mower deck. (SGM-12)

When you get to the end of a pass, slightly raise the mower (2-4") before turning. Never raise the mower entirely while the blades are turning. If the mower must be raised higher than 12" from ground level, disengage the tractor PTO and wait for all mower rotation to come to a complete stop before proceeding to raise the mower. OPS-R-0027_B



OPERATION

WARNING

Do not let the Blades turn when the Mower Deck is raised for any reason, including clearance or for turning. Raising the Mower deck exposes the Cutting Blades which creates a potentially serious hazard and could cause serious injury or even death from objects thrown from the Blades. (SRM-07)

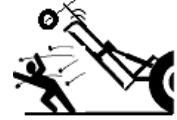

OPERATION

Large, dense, or wet vegetation may need to be mowed in two or more passes to achieve a uniform cut. In such conditions, raise the cutting height to 12" or more on the first pass. OPS-R-0043



Then lower the mower to the desired height and mow the vegetation a second time. If possible, select a mowing pattern that is at a 90 degree angle to the first pass to reduce streaking for a more uniform cut. OPS-R-0044



OPERATION

10.6 Right of Way (Highway) Mowing

- **USE DOUBLE CHAIN GUARDS** for highway, right-of-way, parks, greenbelt mowing, or all other mowing where human dwellings, vehicles, or livestock could be within 300 feet of the mower.
- No shielding is 100% effective in preventing thrown objects. To Reduce Possibility of Injury:
 1. **MAINTAIN MOWER SHIELDING** in good operational condition,
 2. **DAILY INSPECT** the condition of the Thrown Object Guards, mower Side Skirts, and skid shoes: Replace or repair worn or damaged guards.
 3. **DAILY INSPECT** the condition of the Blades and Blade Bolts. Replace any cracked, worn, bent or damage blades. Always replace blade bolts and nuts when replacing blades. Make sure the blade bolts are properly tightened.
 4. **RAISE CUTTING HEIGHT** to **6 INCHES** minimum.
 5. **INSPECT AREA** thoroughly before mowing to **REMOVE** potential **THROWN OBJECT HAZARDS**.
 6. **NEVER ALLOW BLADES** to **CONTACT SOLID OBJECTS** like wire, rocks, posts, curbs, guardrails, or ground while mowing.



ROTARY MOWERS CAN THROW OBJECTS 300 FEET OR MORE UNDER ADVERSE CONDITIONS.

TO AVOID SERIOUS INJURY OR DEATH TO OPERATOR OR BYSTANDERS FROM THROWN OBJECTS:

INSPECT AREA FOR POTENTIAL THROWN OBJECTS BEFORE MOWING:

- **REMOVE** debris, rocks, wire, cable, metal objects and other foreign material from area.

Wire, cable, rope, chains and metal objects can be thrown or swung outside deck with great velocity:

1. **MARK** objects that cannot be removed.
2. **AVOID** these objects when mowing.

STOP MOWING IF PASSERSBY IS WITHIN 300 FEET UNLESS:

- All **THROWN OBJECT SHIELDING** including Front and Rear Deflectors, Chain Guards, Steel Guards, Bands, Side Skirts and Skid Shoes are in place and in good condition when mowing.
- Mower sections or wings are adjusted to be close and parallel to ground without exposing blades.
- **MOWING AREA** has been inspected and foreign materials and debris have been removed.
- **PASSERSBY** are inside enclosed vehicle. *OPS-U-0040*

OPERATION

10.7 Shutting Down the Implement

To shut down attached mower head, first bring the tractor to a complete stop. Decrease engine RPM to idle then disengage cutterhead. The mower head will come to a complete stop within a suitable amount of time. Do not engage or disengage the cutterheads at a high RPM unless there is an emergency situation.



Park the tractor on a level surface, place the transmission in park or neutral and apply the parking brake, lower the attached implement to the ground, shut down the engine, remove the key, and wait for all motion to come to a complete stop before exiting the tractor. *OPS-U-0016*



11. DISCONNECTING THE MOWER FROM THE TRACTOR

Before disconnecting the mower, the PTO must be disengaged and blade rotation at a complete stop. Move the mower to a level storage location and lower it to the ground. If the mower is not resting securely on the ground, block the mower up securely before attempting to disconnect it from the tractor.

Use extreme care to keep feet and hands from under the mower and clear of any pinch points caused by the tractor hitch arms and mower pins. *OPS-R-0030_A*



Never stand or allow another person to stand between a running Tractor and the Mower when disconnecting the Implement from the Tractor 3-point hitch.

OPERATION

▲ DANGER

Always shut the Tractor completely down, place the transmission in park, and set the parking brake before you or anyone else attempts to connect or disconnect the Implement and Tractor hitches. (S3PT-15)

▲ WARNING

Never unhitch without using the Tongue Jack. The Tongue is very heavy. Attempting to lift the Tongue without using the Tongue Jack could cause strains or other injury. Allowing the tongue to fall suddenly and unexpectedly could result in crushing injury. Use the Tongue Jack for lifting the Implement only. Overloading the Tongue Jack can cause failure with possible serious bodily injury or even death. (STI-04)

Lift-Type Mower - To disconnect the mower, first extend the tractor 3-point hitch top link to remove tension on the top link hitch pin. When the pin is loose and easy to rotate, remove the pin from the mower. Next remove both lower hitch pins.

Pull-Type Mower - To disconnect the mower, first relieve hydraulic pressure by moving the control lever back and forth several times. Lower the parking jack and raise the mower until the tongue clevis is no longer resting on the tractor drawbar and is supported solely by the jack. Make sure that the jack foot is securely resting at ground level or supported by a block. Then remove the hitch bolt, locknut, and washers. If a hydraulic cylinder was used, remove its hose end from the tractor port and secure it to the mower to prevent contact with dirt.

After disconnecting the 3 lift points, remove the mower driveline from the tractor PTO shaft. Lay the driveline down carefully to avoid damaging the driveline or its shield. Do not let the driveline fall into mud or dirt, which can contaminate the bearing and shorten the life of the driveline. OPS-R-0031_A

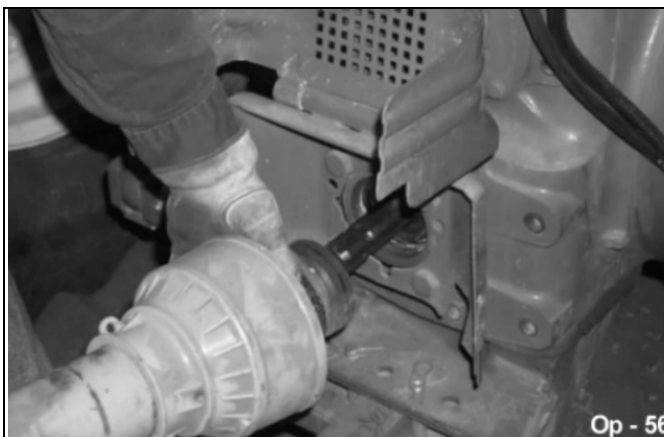

OPERATION

12. MOWER STORAGE

Properly preparing and storing the mower at the end of the season is critical to maintaining its appearance and to help ensure years of dependable service. The following are suggested storage procedures:

- Thoroughly clean all debris off the mower to prevent damage from rotting grass and standing water.
- Lubricate all mower grease points and fill gearbox oil levels as detailed in the maintenance section.
- Tighten all bolts and pins to the recommended torque.
- Check the mower for worn and damaged parts. Perform repairs and make replacements immediately so that the mower will be ready for use at the start of the next season.
- Store the mower in a clean, dry place with the mower housing resting securely on blocks or at ground level.
- Keep the driveline yoke from sitting in water, dirt and other contaminants.
- Use spray touch-up enamel where necessary to prevent rust and maintain the appearance of the mower.



It is critical that driveline clutches slip when an obstacle or heavy load is encountered to avoid mower and/or tractor damage. If the mower sits outside for an extended period of time or is exposed to rain and/or humid air, the clutch lining plates must be inspected to ensure they are not frozen together from rust or corrosion. If the mower has been exposed to such conditions, at the start of each mowing season, and any time it is suspected that the slip clutch plates may be frozen together, readjust the slip clutch as detailed in Seasonal Clutch Maintenance of the maintenance section in this manual. OPS-R-0032_A



Never allow children or other persons to ride on the Tractor or Implement.
Falling off can result in serious injury or death. (SG-10)



13. TRANSPORTING THE TRACTOR AND IMPLEMENT

Inherent hazards of operating the tractor and implement and the possibility of accidents are not left behind when you finish working in an area. Therefore, the operator must employ good judgement and safe operation practices when transporting the tractor and implement between locations. By using good judgement and following safe transport procedures, the possibility of accidents while moving between locations can be substantially minimized. OPS-U-0017

OPERATION

Before transporting the tractor and mower, idle the tractor engine, disengage the PTO and wait for all mower moving parts to come to a complete stop. Once all mower parts are completely stopped, raise the mower to transport height. **NOTE:** When raising the mower, maintain 1" clearance between the driveline and mower deck. If additional mower deck height is needed for safe transport, disconnect the driveline from the tractor and secure its end to the mower deck. The mower can then be raised to the maximum lift height. OPS-R-0033_A



If the tractor's hydraulic pump is not independent of the tractor PTO, or if the tractor PTO has to be run to have hydraulic power, disconnect the mower driveline from the tractor PTO output shaft. Secure the driveline to the mower deck to prevent driveline damage or loss during transport. OPS-R-0034



OPERATION

13.1 Transporting on Public Roadways

Extreme caution should be used when transporting the tractor and implement on public roadways. The tractor must be equipped with all required safety warning features including a SMV emblem and flashing warning lights to alert drivers of the tractor's presence. Remember that roadways are primarily designed for automotive drivers and most drivers will not be looking out for you, therefore, you must look out for them. Check your side view mirrors frequently and remember that vehicles will approach quickly because of the tractor's slower speed. Be extremely cautious when the piece of equipment that you are towing is wider than the tractor tire width and/or extends beyond your lane of the road.

Make sure that a proper size safety tow chain is secured between the tractor and implement before entering a public road. OPS-U-0019



Make certain that the "Slow Moving Vehicle" (SMV) sign is installed in such a way as to be clearly visible and legible. When transporting the Equipment use the Tractor flashing warning lights and follow all local traffic regulations. (SG-6)

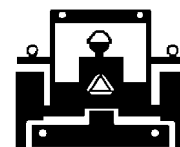

OPERATION

OPERATION

The SMV (Slow-Moving Vehicle) emblem is universal symbol used to alert drivers of the presence of equipment traveling on roadways at a slow speed. SMV signs are a triangular bright orange with reflective red trim for both easy day and night visibility. Make sure the SMV sign is clean and visible from the rear of the unit before transporting the tractor and implement on a public roadway. Replace the SMV emblem if faded, damaged, or no longer reflective. *OPS-U-0020*



Make sure that all tractor flashing warning lights, headlights, and brake/tail lights are functioning properly before proceeding onto public roads. While newer model tractors have plenty of lighting to provide warning signals and operating lighting, most older models are only equipped with operating lights. Consult an authorized tractor dealer for lighting kits and modifications available to upgrade the lighting on older tractor models. *OPS-U-0021*



When operating on public roads, have consideration for other road users. Pull to the side of the road occasionally to allow all following traffic to pass. Do not exceed the legal speed limit set in your country for agricultural tractors. Always stay alert when transporting the tractor and implement on public roads. Use caution and reduce speed if other vehicles or pedestrians are in the area. *OPS-U-0022_A*



OPERATION

Reduce speed before turning or applying the brakes. Ensure that both brake pedals are locked together when operating on public roads. OPS-U- 0023



OPERATION

13.2 Hauling the Tractor and Implement

Before transporting a loaded tractor and implement, measure the height and width dimensions and gross weight of the complete loaded unit. Ensure that the load will be in compliance with the legal limits set for the areas that will be traveled through

Use adequately sized and rated trailers and equipment to transport the tractor and implement. Consult an authorized dealer to determine the proper equipment required. Using adequately sized chains, heavy duty straps, cables and/or binders, securely tie down both the front and rear of the tractor utilizing the proper tie down locations as specified by the tractor manufacturer.

Arrange the chains so that when tightened, the chains are pulling downward and against themselves. Carefully tighten the securing chains or other fasteners using boomers or binders to apply maximum tension. Use extreme care when attaching and removing the securing devices as the extreme tension involved when released has the potential to inflict serious injury.

While hauling the tractor and implement, make occasional stops to check that the tractor and implement have not moved or shifted and that the securing chains have maintained tension. If during transport a hard braking, sharp turning, or swerving action was performed, stop at the next safe location to inspect the security of the load.

OPERATION

14. TROUBLESHOOTING GUIDE

Problem	Possible Cause	Remedy
Uneven Cut	Excessive ground speed. Blades worn, dull, or bent.	Reduce ground speed. Replace blades. (Refer to "Maintenance" section).
	Mower not level side to side. Improper height adjustment.	Adjust. (Refer to "Assembly" section) Adjust Mower height. (Refer to "Assembly" section)
	Low tractor tire pressure on one side	Adjust tire pressure. (Refer to your tractor operator's manual)
	Turning too fast. Tractor tires push grass down.	Reduce ground speed when turning. Adjust your tractor wheel spacing. (Refer to "Operation" section)
	Damaged Mower pan.	Repair or replace as necessary.
Uncut Material	Excessive ground speed RPM too low	Reduce ground speed. Use full PTO speed. (Refer to your tractor operator's manual)
	Improper blade for direction of cut.	Install blades so rotation is correct.
Poor Shredding	Excessive ground speed.	Raise the front of Mower relative to the rear to hold and circulate material longer. (Refer to the "Operation Section-Setting the Mower-Setting Deck Height") Reduce ground speed.
	Cutting too high.	Lower cutting height. (Refer to the "Operation Section-Setting the Mower-Setting Deck Pitch")
Windrowing or Uneven	Material heavy and lush.	Raise the front of Mower relative to the rear. (Refer to the "Operation Section Setting the mower-Setting Deck Height")
	Excessive ground speed Conditions too wet.	Reduce ground speed. Wait for conditions to dry. Reduce ground speed.

OPERATION

Blade Bolts Working Loose	Bolts not tightened. Bolt hole elongated or oversized. Locknut worn out.	Tighten Bolts to 300 ft./lbs. Replace Blade Carrier. Replace Locknut.
Gearbox Noisy	Low Lubricant. Rough gears. Worn Bearing.	Check lubricant level. Run in or change Gears. Replace Bearing.
Gearbox Leaking	Damaged Oil Seal. Bent Shaft. Oil Seal Race rough. Oil Seal installed wrong. Oil Seal not sealing in the housing. Oil level too high. Gasket damaged. Bolts loose. Sand hole in casting.	Replace Seal. Replace Oil Seal and Shaft. Replace Shaft or repair Race. Replace Seal. Replace Seal or use a sealant on O.D. of Seal. Drain oil to proper level. Replace Gasket. Tighten Bolts. Replace castings or gearbox.
Streaking Conditions	Conditions too wet for cutting. Blades unable to cut that part of grass pressed down by path of tractor tires. Dull blades. Height of cutter lower at rear or front.	Allow grass to dry before cutting. Slow ground speed of tractor but keep engine running at full PTO wpm. Lowering the cutting height may help. Sharpen or replace blades. See Cutting Height Instructions.
Gearbox Overheating	Low on lubricant. Improper type lubricant. Excessive trash build-up around gearbox. Bearing or gears set up improperly.	Fill to level plug. Replace with proper lubricant. Remove trash. Consult your Dealer.
Shear Pin Shears Excessively	Tractor PTO not being run at 540 RPM. Heavy Material. Not using proper pin. PTO engaged at high engine RPM Cutting in rocky conditions Blade carrier RPM too high. Blades not properly heat treated.	Run at 540 RPM. Reduce ground speed. Raise cutting height. Replace only with recommended shear pin. Idle engine to engage PTO Increase cutting height. Check gearbox ratios. Consult your Dealer.



MAINTENANCE SECTION

Maintenance Section 5-1

MAINTENANCE

MAINTENANCE

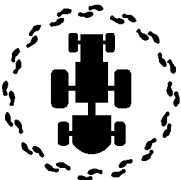
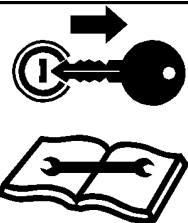
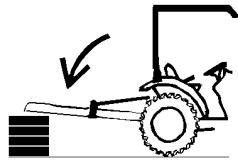
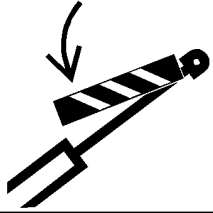
HAZARDS WITH MAINTENANCE OF IMPLEMENT

				
Periodically inspect all moving parts, lubricate drivelines, and tighten all fasteners	Stop engine remove key before conducting maintenance	Block up implement before servicing Use large blocks on soft or wet soil	Engage cylinder transport locks	Inspect Blades for damage or cracks

WARNING

AVOID SERIOUS INJURY OR DEATH FROM COMPONENT FAILURE BY KEEPING IMPLEMENT IN GOOD OPERATING CONDITION IN PERFORMING PROPER SERVICE, REPAIRS AND MAINTENANCE.

BEFORE PERFORMING SERVICE, REPAIRS AND MAINTENANCE ON THE IMPLEMENT:

- **STOP ENGINE AND PTO**, engage parking brake, lower implement, allow all moving parts to stop and remove key before dismantling from tractor.
- **PLACE** implement on ground or securely block up raised equipment. Use large blocks on soft or wet soil.
- **PUSH** and **PULL** Remote Hydraulic Cylinder lever to relieve hydraulic pressure.
- **DISCONNECT IMPLEMENT** driveline from tractor **PTO SHAFT**.

WEAR SAFETY GLASSES, PROTECTIVE GLOVES and follow **SAFETY PROCEDURES** when performing service, repairs and maintenance on the implement:

- Always **WEAR** protective **GLOVES** when handling blades, knives, cutting edges or worn component with sharp edges.
- Always **WEAR GLOVES** and **SAFETY GLASSES** when servicing hot components
- **AVOID CONTACT** with hot hydraulic oil tanks, pumps, motors, valves and hose connection surfaces.
- **SECURELY** support or **BLOCK UP** raised implement, framework and lifted components before working underneath equipment.
- **STOP** any implement movements and **SHUT-OFF TRACTOR** engine before doing any work procedures.
- **USE** ladder or raised stands to reach high equipment areas inaccessible from ground.
- **ENSURE** good footing by standing on solid flat surfaces when getting on implement to perform work.
- **FOLLOW** manufacturer's instructions in handling oils, solvents, cleansers, and other chemical agents.
- **DO NOT** change any factory-set hydraulic calibrations to avoid component or equipment failures.
- **DO NOT** modify or alter implement, functions or components.
- **DO NOT WELD** or repair rotating mower components. These may cause vibrations and component failures being thrown from mower.

PERFORM SERVICE, REPAIRS, LUBRICATION AND MAINTENANCE OUTLINED IN IMPLEMENT MAINTENANCE SECTION:

- **INSPECT** for loose fasteners, worn or broken parts, leaky or loose fittings, missing or broken cotter keys and washers on pins, and all moving parts for wear.
- **REPLACE** any worn or broken parts with authorized service parts.
- **LUBRICATE** unit as specified by lubrication schedule
- **NEVER** lubricate, adjust or remove material while it is running or in motion.
- **TORQUE** all bolts and nuts as specified.

BLADE INSPECTION:

- **REPLACE** bent, damage, cracked or broken blades immediately with new blades.
- **AVOID** blade failures and thrown broken blades. **DO NOT** straighten, weld, or weld hard-facing blades.

SAFETY SHIELDS, GUARDS AND SAFETY DEVICES INSPECTION:

- **KEEP** all Deflectors, Chain Guards, Steel Guards, Gearbox Shields, and PTO integral shields, Bands, Side Skirts and Skid Shoes in place and in good condition.
- **REPLACE** any missing, broken or worn safety shields, guards and safety devices.
- Engine Exhaust, some of its constituents, and certain vehicle components contain or emit chemicals known to the state of California to cause cancer, birth defects or other reproductive harm.
- Battery posts, terminals and related accessories contain lead and lead compounds, chemicals known to the state of California to cause cancer, birth defects or other reproductive harm. **PN HM01**

MAINTENANCE

PARTS INFORMATION

Rhino mowers use balanced and matched system components for blade carriers, blades, cuttershafts, knives, knife hangers, rollers, drivetrain components, and bearings. These parts are made and tested to Rhino specifications. Non-genuine "will fit" parts do not consistently meet these specifications. The use of "will fit" parts may reduce mower performance, void warranties, and present a safety hazard. Use genuine Rhino mower parts for economy and safety. (SPRM-1)

SEE YOUR RHINO DEALER

Before operating your Rotary Cutter, make sure it is properly lubricated and thoroughly inspected. Only a minimum of time and effort is required to regularly lubricate and maintain this machine to provide long life and trouble free operation.



Always disengage the PTO before raising the Rotary Cutter for transporting or making adjustments.

Lubrication

Do not let excess grease collect on or around parts, particularly when operating in sandy areas. The illustrations below shows lubrication points (**Figure Mnt-R-0393/Mnt-R-0394**). The chart gives the frequency of lubrication in hours, based on normal operating conditions. Severe or unusual conditions may require more frequent lubrication.

Use Multi-Purpose Gear Oil P/N 00786250 when required in Gearbox. Use N.L.G.I #2 grease for all locations designated with grease gun. Be sure to clean the fitting thoroughly before using grease gun. Failure to maintain proper lubrication will result in damage to U-joints, gearbox, and/or driveshaft.

MAINTENANCE

MAINTENANCE

Pull Type- Multi Spindle Greasing Points

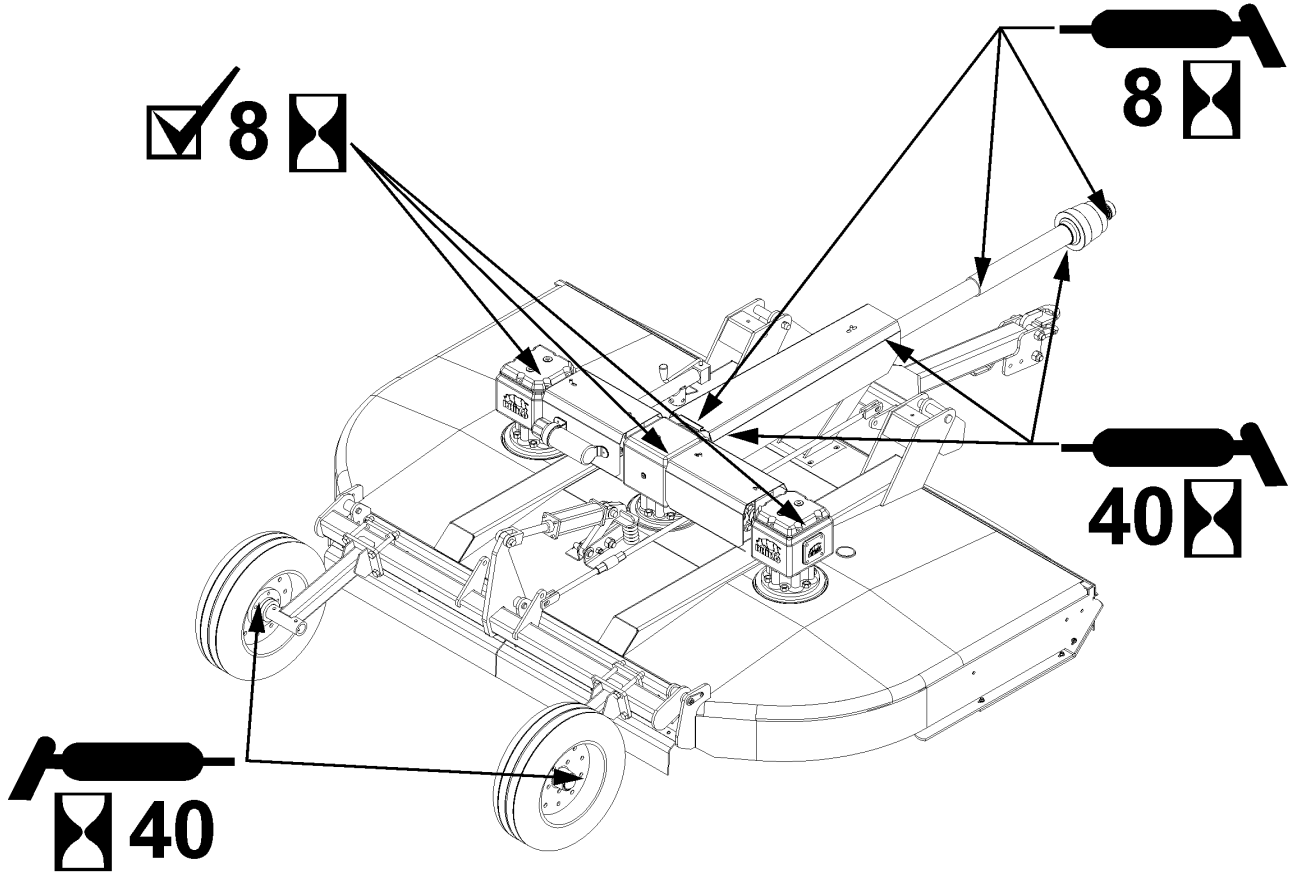

Driveline

U-Joints	8 Hours
Telescoping Tube	8 Hours
Shield Bearings	40 Hours

Gearbox

8 Hours

Tailwheel

Wheel Hubs	40 Hours
Axle Pivot	8 Hours

	Check Gear Oil- Use Multi-Purpose Gear Oil P/N 00786250
	Use N.L.G.I. #2 Grease

Mnt-R-0393

MAINTENANCE

Lift Type Multi Spindle Greasing Points

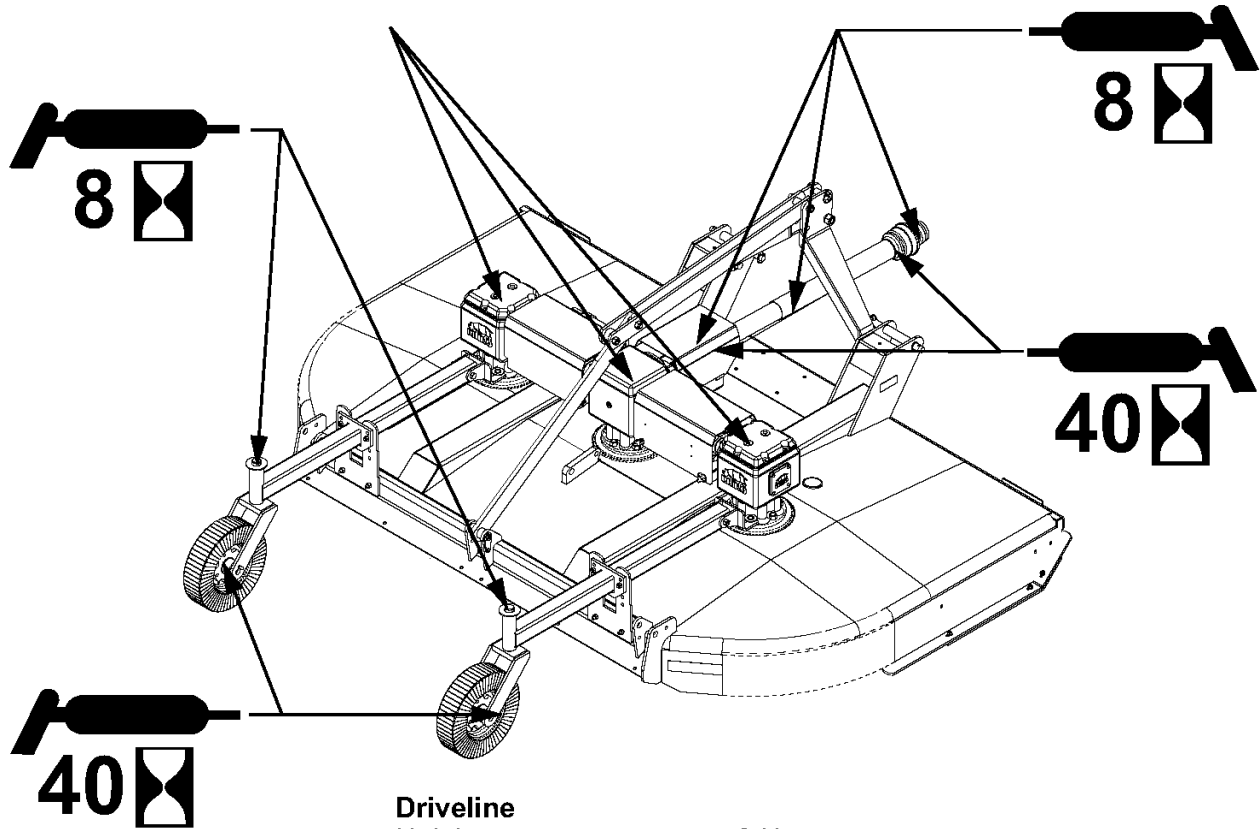

Driveline	
U-Joints	8 Hours
Telescoping Tube	8 Hours
Shield Bearings	40 Hours

Gearbox 8 Hours

Tailwheel	
Castor Forks	8 Hours
Wheel Hubs	40 Hours

	Check Gear Oil- Use Multi-Purpose Gear Oil P/N 00786250
	Use N.L.G.I. #2 Grease

Mnt-R-0394

MAINTENANCE

MAINTENANCE

GEARBOX

The Gearbox has been filled with lubricant to the Test Plug Level prior to shipment. However, you should check the oil level at Test Plug before operating, and frequently thereafter.

The gearbox should not require additional lubricant unless the box is cracked or a seal is leaking. It is recommended that the oil level plug be removed after every 8 to 10 hours of operation and oil added until it runs out Test Plug hole. The Test Plug is located on the rear of the Gearbox. Filler Plug is located on top of Gearbox. See **Figure MntP-0001& Mnt-R-0117**.

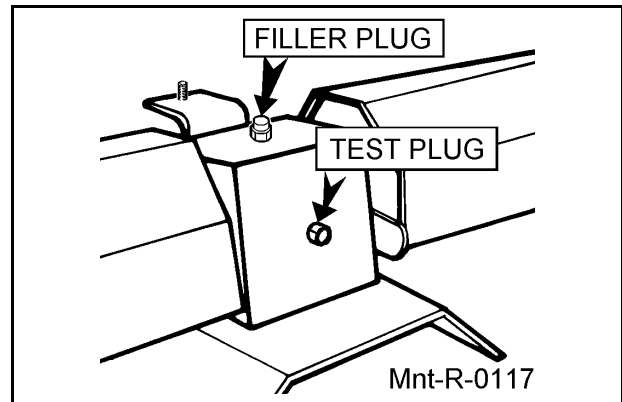

Use Multi-Purpose Gear Oil P/N 00786250 for all locations shown according to instructions.

NOTE: *Overfilling the Gearbox will cause pressure to build up and cause Oil Seals to leak.*

ATTENTION: *If the Gearbox suddenly starts making an unusual noise, stop at once, check for leaks, and refill Gearbox as required.*

DRIVELINES

CAUTION

Many of the equipment components are **HEAVY** (70 lbs or greater) and Special Lifting Procedures are recommended. Use lifting assistance such as mechanical assistance, two people, and proper lifting techniques when connecting or installing the driveshaft to reduce the possibility of back injuries.

The Drivelines and U-Joints should be inspected each morning before the mower is started.

The U-Joint and CV Joint on the Driveline undergo extreme forces when the unit is turning or when the Wings are being raised. It is important that the U-Joints and CV Joint be greased per schedule before the unit is started. The U-Joints are located at each end of the Center and Wing Drivelines. The CV Joint is located at the end of the Main Driveline. The U-Joint and CV Joint assemblies are accessible by rotating the Driveline Safety Shield until the hole in the Shield matches up with the Grease Fitting. Lubricate all fittings with a good quality Lithium Soap compatible E.P. grease meeting the N.L.G.I. #2 specifications and containing no more than 1% Molybdenum Disulfide. An E.P. grease meeting the N.L.G.I. #2 specifications and containing 3% Molybdenum Disulfide may be substituted in the telescoping members only. Inspect the U-Joint for wear by holding the shaft on one side of the U-Joint while trying to rotate the shaft on the other side of the U-Joint. If there is noticeable movement in the Driveline replace the U-Joint before it causes severe damage to the Driveline.

MAINTENANCE

MAINTENANCE

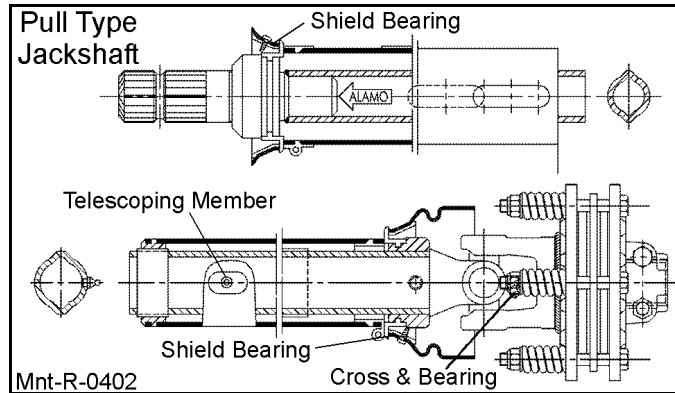
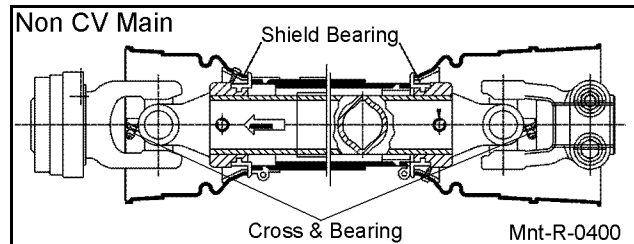
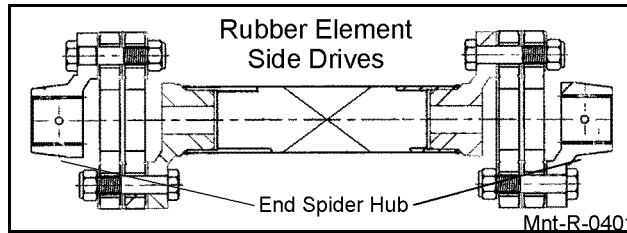
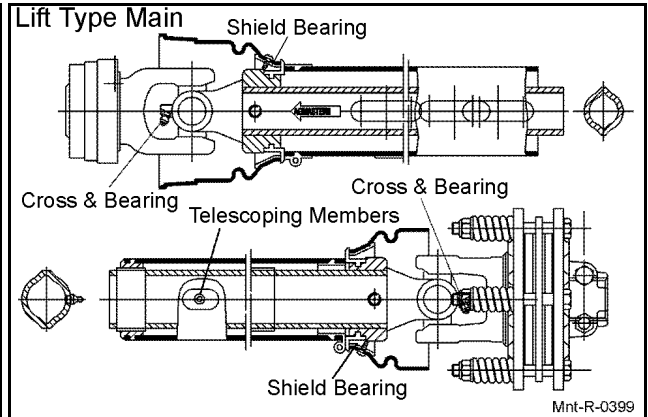
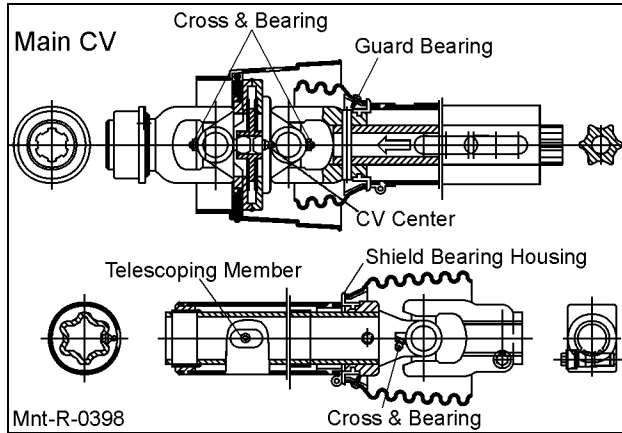

<u>LOCATION</u>	<u>EXTENDED LUBE INTERVAL</u>	<u>LEVER ACTION PUMPS</u>
Cross & Bearings	8 Hours	2 - 3
Telescoping Tube	8 Hours	6 - 8
Shield Bearings	50 Hours	1 - 2
End Spider Hub	20 Hours	1 - 2
CV Center Housing	8 Hours	12 - 15

MAINTENANCE

MAINTENANCE

MAIN & JACKSHAFT DRIVELINE SHIELDS

To remove the main inner driveline shield, Remove the locking screws. Align the bearing tabs with the cone pockets. **FIGURE Mnt-0026.** Remove the half-guard and remove the bearing ring. **FIGURE Mnt-R-0012.**

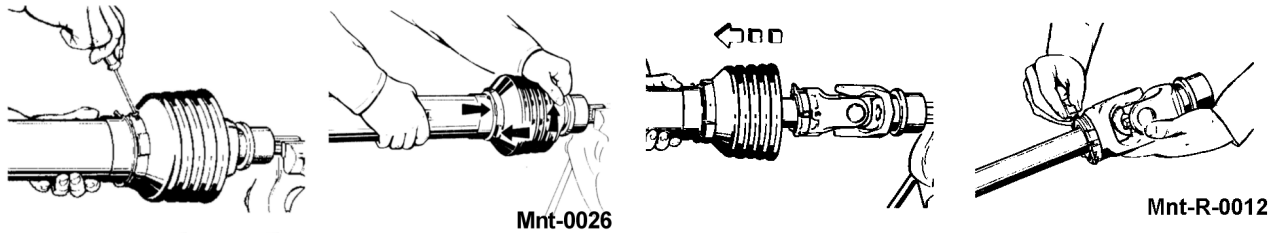

Inspect the driveline shield for worn areas or cracks. If the shield has any dents or cracks, replace the Shield. While the Shields are off, examine the Driveline for signs of abnormal wear, bent or twisted shafts, or cracks in the shafts or tubes. Check to see that the Drivelines telescope easily. If the Drivelines do not telescope properly or show signs of abnormal wear, the shaft should be repaired or replaced.

To assemble the main inner driveline shield, grease the yoke groove and inner profile tube. Attach the bearing ring in groove with recesses facing profile tube. **FIGURE Mnt-0027.** Slide on the half shield. Turn the cone until it engages correctly. Install locking screws. **FIGURE Mnt-0028.**

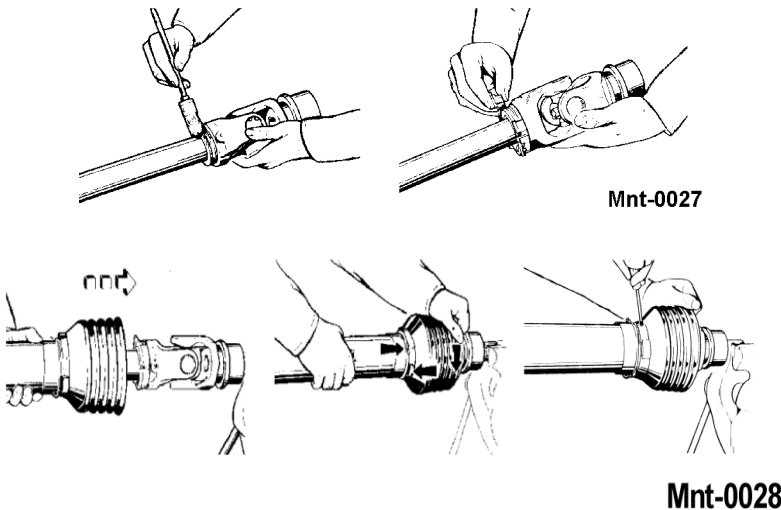

IMPORTANT!

Check that Guard Missing decal on steel tube under inner guard and Rotating Driveline Decal are firmly affixed, undamaged and readable. If not, replace.



MAINTENANCE

MAINTENANCE

MAIN CV DRIVELINE SAFETY SHIELD (FIGURE Mnt-R-0032)

To remove the outer CV cone, remove the locking screws from shield cone. Remove cone over yoke. **MNT-R-0038**. Remove bearing ring and remove the locking screws from inner shield cone. **Mnt-R-0038**. Turn inner cone to assembly position and remove half shield. Remove bearing ring. **MNT-R-0038**.

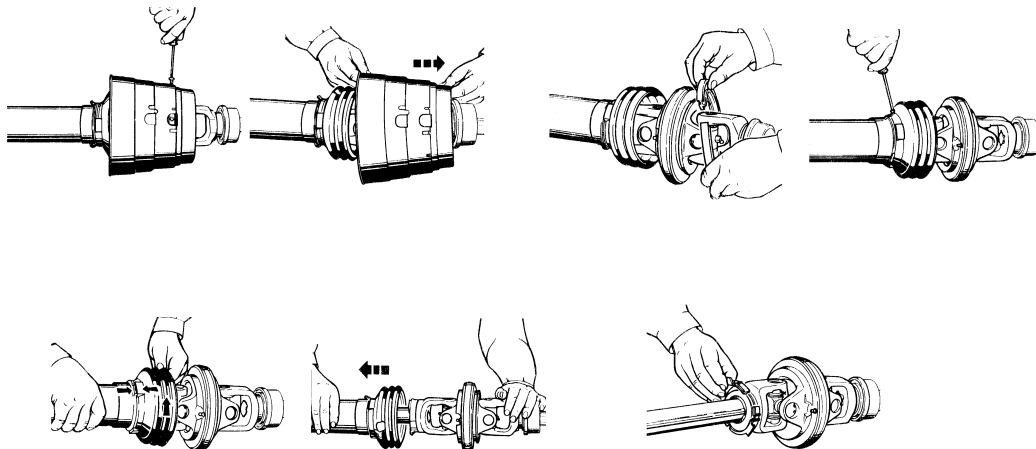

Mnt-R-0038

To assemble outer CV driveline, grease yoke groove and inner profile tube. Attach bearing ring on groove with recesses facing profile tube. Slide on half shield with cone. Turn cone until it engages correctly. Tighten locking screws. Grease bearing groove in double yoke. Insert bearing ring. Slide guard cone for double yoke over cam from the connecting end. Make sure holes for screws are visible. Tighten locking screws. **MNT-R-0039**

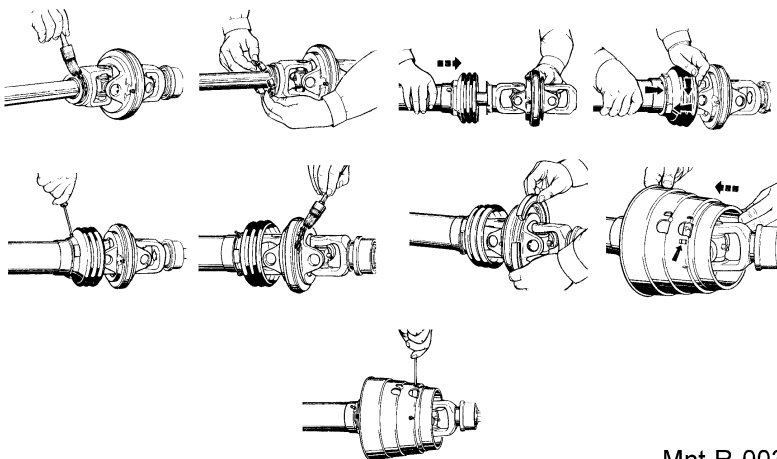

Mnt-R-0039

Important! Check that Guard Missing decal on steel tube under inner guard and Rotating Driveline Decal are firmly affixed, undamaged and readable. If not, replace.



MAINTENANCE

DRIVELINE TAPER CONE YOKE REMOVAL INSTRUCTIONS

1. Loosen 11/16" bolt end one revolution.
2. Insert drift punch (max. diameter 0.375) into hole opposite the hex head and impact with hammer.
3. Repeat operations 1 & 2.
4. Remove clamping cone from yoke and yoke from shaft.

NOTE: The clamping cone is serviced only as a complete assembly. Do not attempt to disassemble the clamping cone.

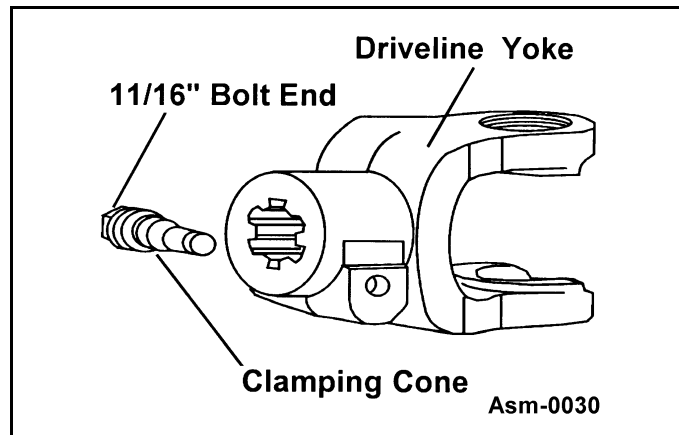

BLADE SERVICING

Inspect blades before each use to determine that they are properly installed and in good condition. Replace any blade that is bent, excessively nicked, worn, or has any other damage. Small nicks can be ground out when sharpening.

WARNING

Use only original equipment blades on this cutter. They are made of special heat-treated alloy steel. Substitute blades may not meet specifications and may fail in a hazardous manner that could cause injury.

DANGER

Replace bent or broken blade with new blades. NEVER ATTEMPT TO STRAIGHTEN OR WELD ON BLADES SINCE THIS WILL LIKELY CRACK OR OTHERWISE DAMAGE THE BLADE WITH SUBSEQUENT FAILURE AND POSSIBLE SERIOUS INJURY FROM THROWN BLADES. (SGM-10)

- Manually wiggle the blade carriers to check for any looseness.
- Retighten any loose parts.
- Recheck torque every 50 hours.

Important

Operating with loose blade hardware will damage the blade holder and blades. Whenever the blades have been removed or replaced, the hardware must be retightened after the first eight hours of operation. On new units check blade hardware and the blade nut torque after first 8 hours.

Important

Operating with loose blade holder will damage the blade holder and output shaft, two initial tightenings are required. Retighten after one hour and again after the day of operation. In severe cutting conditions or commercial use, a daily inspection is required.

Important

To help prevent structural damage caused by loose hardware, tighten gear case hardware as specified. Check torque after first 8 hours of use and every 50 hours thereafter.

NOTE: Replace Blades in pairs after no more than 1/2" notch wear!

MAINTENANCE

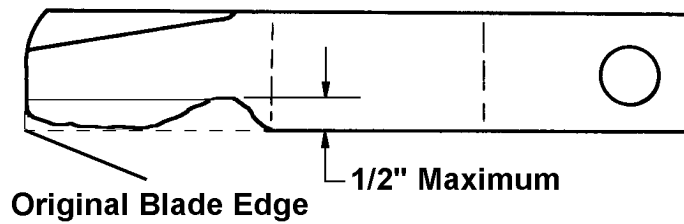

Mnt-R-0034

MAINTENANCE

BLADE SHARPENING

Always sharpen both blades at same time to maintain balance. Follow original sharpening pattern as shown in **Mnt-R-0008**. Always sharpen blades by grinding. DO NOT heat and pound out edge. Do not sharpen blade to a razor edge, but leave a 1/16" blunt edge. Do not sharpen back side of blade.



DANGER Avoid personal injury. Always block the cutter up to prevent it from falling when the blades and/or carrier are being serviced.



WARNING Do not heat or weld on hard surface blades as this can alter material strength causing blades to fail in a hazardous manner that could cause injury.

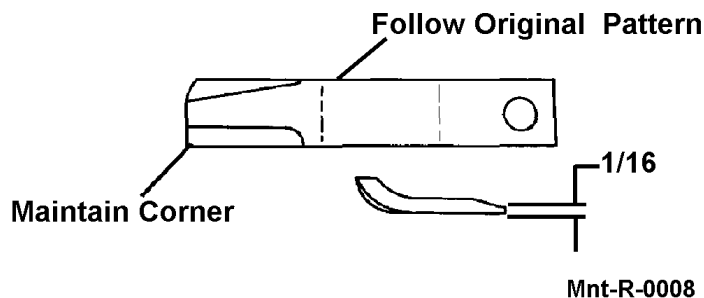

BLADE CARRIER REMOVAL

Remove cotter pin and loosen slotted nut on gearbox shaft. Loosen but do not remove the nut until the blade carrier is loosened. Use a suitable 2 jaw gear puller to pull carrier off tapered gearbox shaft. If gear puller is not available use long bar inserted through blade bolt access hole with end against rotor bar. Strike opposite end of bar with sledge hammer. Rotate blade carrier 180 degrees and repeat process.

MAINTENANCE

MAINTENANCE

BLADE CARRIER INSPECTION

Blade bolt fit into carrier bushings should be checked every time blades are changed. The blade bolt should fit into carrier bushings as a snug slip fit. If the blade bolt fit appears to be loose or sloppy, measure the square hole in bushing. If the bottom of the square hole is $1/16$ " or greater than the square shoulder of the new blade bolt the bushings should be replaced. Bushings can be removed by cutting bushing head where it is welded to carrier bar. Once head is removed bushing can be pressed out of bar. Clean and grind top of blade bar so new bushing can be installed and welded. Bushing should be pressed into bar as far as possible. Use low hydrogen rod to weld bushing in place.



Failure to replace a worn blade carrier bushing as described above may lead to catastrophic failure of the blade, blade bolt, and/or blade bolt nut resulting in the ejection of the broken parts out from under the mower at tremendous speed and force which could result in serious bodily injury or death.

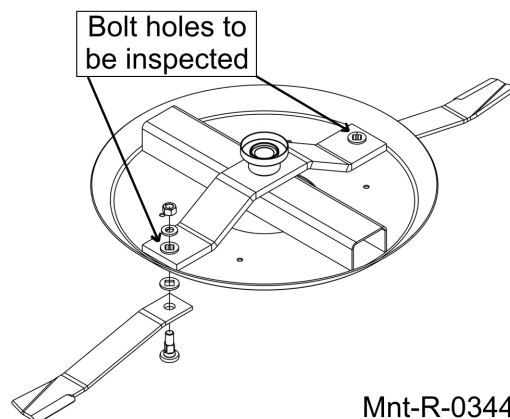
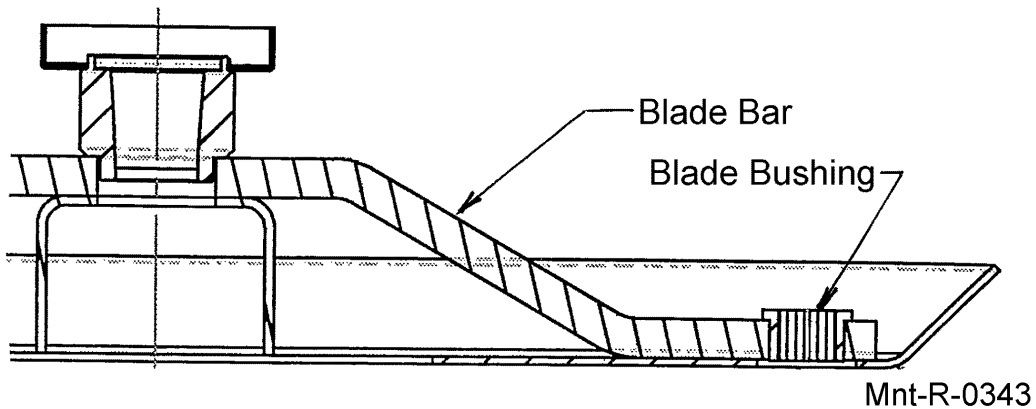

MAINTENANCE

BLADE CARRIER INSTALLATION

Clean the splines on both the blade carrier and output shaft. Position carrier on the gearbox output shaft and install special washer, and nut.

Tighten nut holding blade carrier to minimum 600 ft. pounds, strike the carrier near the hub several times with a heavy hammer to seat the hub. Use a suitable spacer over the nut to prevent damage to the nut and threads. Retighten the nut to 600 ft. pounds. Install cotter pin and spread.

Important

Operating the mower with a loose blade pan or holder can damage the taper connection on the gearbox output shaft. To ensure proper seating between the blade holder and output shaft, check and tighten the retaining nut after the first day of operation. Recheck the blade carrier attachment each morning before operating. Grasp the carrier firmly with both hands and try to push and pull the carrier with one hand while pulling and pushing with the other hand to try to rock or oscillate the blade carrier. If the carrier is loose, retighten the retaining nut before operating the mower.

Important

Always recheck gearbox output shaft slotted blade carrier retaining nut torque after a few hours operation.

WARNING

Avoid personal injury. Do not work under cutter without support blocks to keep frame from falling.

BLADE REMOVAL

To remove blades for sharpening or replacement, remove the cover plate on deck of cutter near gear box. Remove lock nut from blade bolt.

NOTE: *Inspect lock nut after removal and replace if threads are damaged.*

Always replace nut when replacing blade bolt. When installing blades be sure and check blade bolt pivot diameter for wear. Replace bolt if worn more than 1/4 inch at any point. Install blade bolts with partially worn side of bolt either toward or away from center. Tighten locknut to 600 ft. lbs.

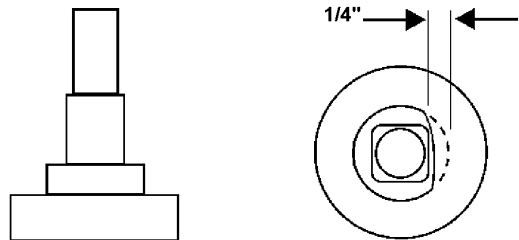

Mnt-R-0014

WARNING

Avoid personal injury. Blade and/or blade carrier removal should be done only with the tractor engine shut off, key removed, in neutral, parking brake on, and PTO disengaged and the cutter blocked in the raised position.

MAINTENANCE

MAINTENANCE

Blade Bolt Inspection

Inspect Blade Bolt Head daily for wear as followed:

Excessive Blade Bolt Wear

Cause: Blade Bolt contacts a foreign or solid object while Blade is in motion.

Remedy: Inspect the area before mowing to determine where the foreign objects are located and place visible hazard markers to identify the areas where immovable foreign objects exist, and avoid hitting the objects.

Notches and Gouges

Cause: Blade Bolt contacting foreign objects.

Remedy: Inspect area to be mowed and remove foreign objects that could cause damage to the blade bolt.

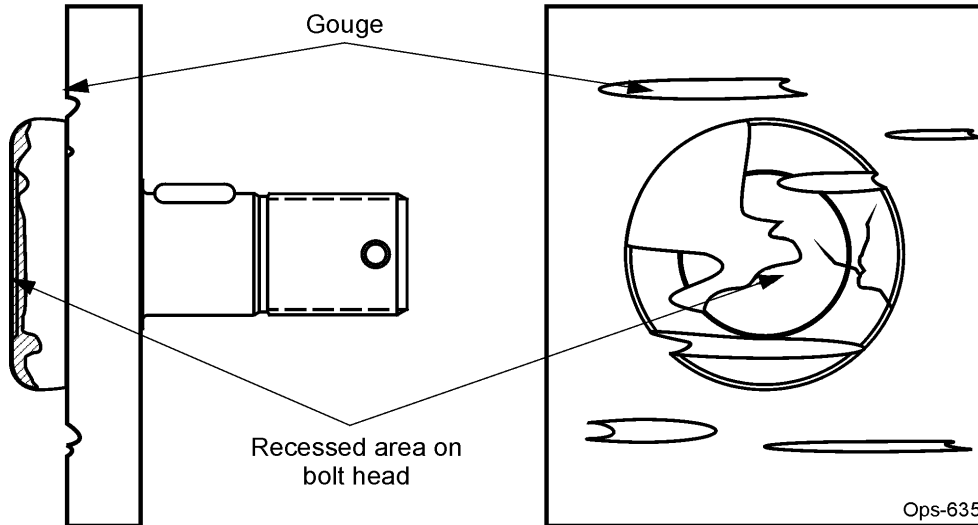

Inspect the Blade Bolt Heads daily for abnormal wear. REPLACE BOTH BLADE BOLTS on the Blades IMMEDIATELY if either blade bolts has:

- Visible cracks or
- If the recessed area on blade bolt is worn off or
- If Blade Bolt has gouges or chipped areas.

Failure to replace abnormally worn blade bolts may lead to catastrophic failure of the blades and ejection of the broken part which may cause serious bodily injury or death.

Always replace Blade Bolts with new bolts whenever replacing the Blades. OPS-U-0037

MAINTENANCE

BLADE TIMING AND ROTATION

(FIGURE Mnt-R-0102)

Blades on multi-spindle mowers overlap cutting paths to ensure a complete cut across the width of the mower and to compensate for blade tip wear. If a gearbox has been repaired, a blade carrier or side driveline has been removed, or other maintenance performed which altered the factory set blade carrier timing, the blades must be re-timed to ensure they will not collide while rotating.

BLADE TIMING PROCEDURE

1. Raise the mower to minimum height to allow sufficient clearance between the mower deck and ground to visually inspect blade carriers.
2. Completely shut down the tractor and secure the tractor in position by placing the tractor in park and setting the parking brake. Securely block the mower at this height.
3. On a side gearbox, remove connecting driveline coupler.
4. Manually rotate carriers until blades are positioned at near 90 degree angle from one another. See Fig. Mnt-R-0102
5. Replace connecting driveline and coupler.
6. Manually spin carriers a complete rotation to ensure blades do not collide with one another.

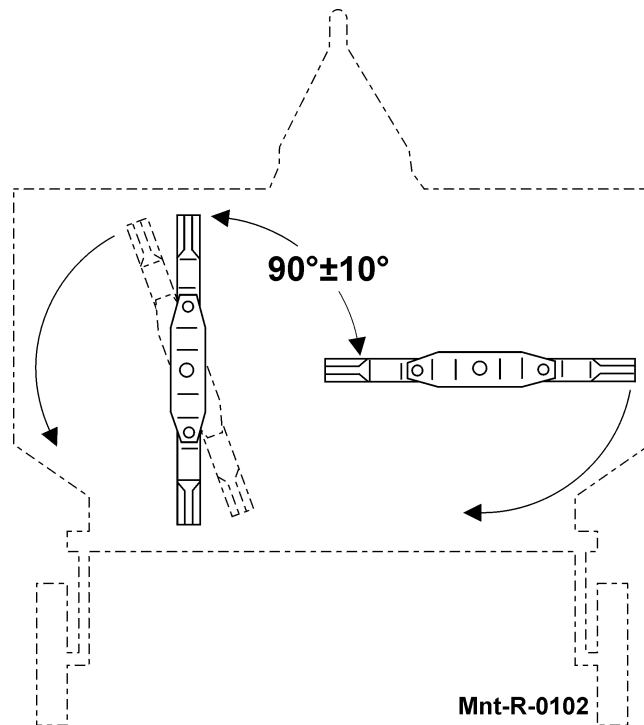

MAINTENANCE

MAINTENANCE

SLIP CLUTCH

A slip clutch is incorporated in the PTO driveline. It is designed to slip, absorb the shock load, and protect the driveline.

After the first hour of operation, the slip clutch should be checked for overheating. After this first check, the slip clutch should be checked weekly or anytime there is overheating. To adjust the slip clutch, tighten the spring bolts to 1-9/16" length. Any increase or decrease in this tightness will change the torque rating and could cause premature failure.

The slip clutch should be checked periodically and adjusted to compensate for wear. The lining plates are 1/8" thick when new. Replace after 1/16" wear. If the mower has been idle for an extended period of time, or in wet weather, before operating check to be sure the friction lining plates are not frozen or rusted together. Should this freezing occur refer to the procedure described in the "Seasonal Clutch Maintenance" section on the next page.

There are two friction lining plates in the slip clutch. These should be checked weekly for oil or grease, wear, and moisture which could cause corrosion on the drive plates.

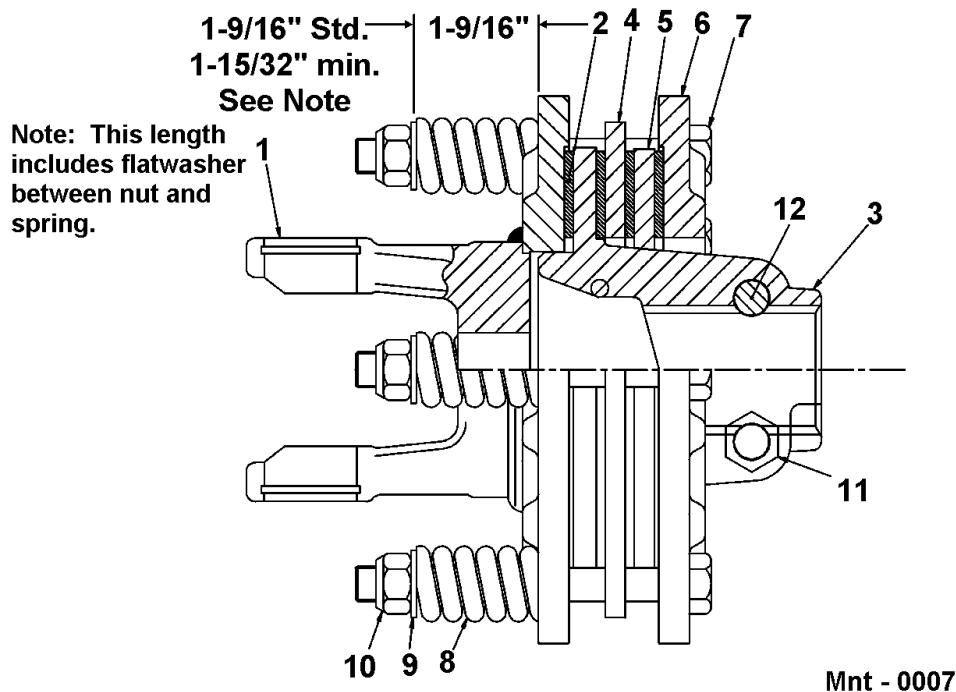

MAINTENANCE

STORAGE

Your rotary cutter represents an investment from which you should get the greatest possible benefit. Therefore, when the season is over, the cutter should be thoroughly checked and prepared for storage so that a minimum amount of work will be required to put it back into operation for the next season. The following are suggested storage procedures:

1. Thoroughly clean the cutter.
2. Lubricate the cutter as covered in Maintenance Section.
3. Tighten all bolts and pins to the recommended torque.
4. Check the cutter for worn or damaged parts. Make replacements immediately.
5. Place driveline in storage position resting on bracket.
6. Store the cutter in a clean, dry place with the cutter housing resting on blocks.
7. Use spray touch-up enamel where necessary to prevent rust and maintain the appearance of the cutter.



MAINTENANCE

PROPER TORQUE FOR FASTENERS

The chart lists the correct tightening torque for fasteners. When bolts are to be tightened or replaced, refer to this chart to determine the grade of bolts and the proper torque except when specific torque values are assigned in manual text.

RECOMMENDED TORQUE IN FOOT POUNDS UNLESS OTHERWISE STATED IN THE MANUAL*

NOTE: These values apply to fasteners as received from supplier, dry or when lubricated with normal engine oil. They do not apply if special graphited or molydisulphide greases or other extreme pressure lubricants are used. This applies to both UNF fine and UNC coarse threads.

MAINTENANCE

MAINTENANCE

TORQUE SPECIFICATIONS

Proper torque for American fasteners.
Recommended Torque in Foot Pounds (Newton Meters).*

AMERICAN Bolt Head Markings

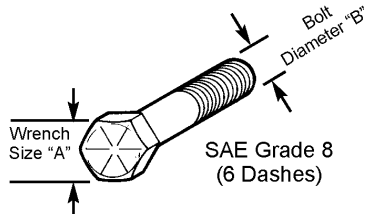

WRENCH SIZE (IN.) "A"	BOLT DIAMETER (IN.) "B" AND THREAD SIZE	SAE GRADE 2	SAE GRADE 5	SAE GRADE 8
7/16	1/4 - 20 UNC	6 (7)	8 (11)	12 (16)
7/16	1/4 - 28 UNF	6 (8)	10 (13)	14 (18)
1/2	5/16 - 18 UNC	11 (15)	17 (23)	25 (33)
1/2	5/16 - 24 UNF	13 (17)	19 (26)	27 (37)
9/16	3/8 - 16 UNC	20 (27)	31 (42)	44 (60)
9/16	3/8 - 24 UNF	23 (31)	35 (47)	49 (66)
5/8	7/16 - 14 UNC	32 (43)	49 (66)	70 (95)
5/8	7/16 - 20 UNF	36 (49)	55 (75)	78 (106)
3/4	1/2 - 13 UNC	49 (66)	76 (103)	106 (144)
3/4	1/2 - 20 UNF	55 (75)	85 (115)	120 (163)
7/8	9/16 - 12 UNC	70 (95)	109 (148)	153 (207)
7/8	9/16 - 18 UNF	79 (107)	122 (165)	172 (233)
15/16	5/8 - 11 UNC	97 (131)	150 (203)	212 (287)
15/16	5/8 - 18 UNF	110 (149)	170 (230)	240 (325)
1-1/8	3/4 - 10 UNC	144 (195)	266 (360)	376 (509)
1-1/8	3/4 - 16 UNF	192 (260)	297 (402)	420 (569)
1-5/16	7/8 - 9 UNC	166 (225)	430 (583)	606 (821)
1-5/16	7/8 - 14 UNF	184 (249)	474 (642)	668 (905)
1-1/2	1 - 8 UNC	250 (339)	644 (873)	909 (1232)
1-1/2	1 - 12 UNF	274 (371)	705 (955)	995 (1348)
1-1/2	1 - 14 UNF	280 (379)	721 (977)	1019 (1381)
1-11/16	1-1/8 - 7 UNC	354 (480)	795 (1077)	1288(1745)
1-11/16	1-1/8 - 12 UNF	397 (538)	890 (1206)	1444 (1957)
1-7/8	1-1/4 - 7 UNC	500 (678)	1120 (1518)	1817 (2462)
1-7/8	1-1/4 - 12 UNF	553 (749)	1241 (1682)	2013 (2728)
2-1/16	1-3/8 - 6 UNC	655 (887)	1470 (1992)	2382 (3228)
2-1/16	1-3/8 - 12 UNF	746 (1011)	1672 (2266)	2712 (3675)
2-1/4	1-1/2 - 6 UNC	870 (1179)	1950 (2642)	3161 (4283)
2-1/4	1-1/2 - 12 UNF	979 (1327)	2194 (2973)	3557 (4820)

METRIC

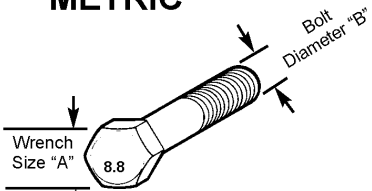

Numbers appearing on bolt heads indicate ASTM class.

*Use 75% of the specified torque value for plated fasteners. Use 85% of the specified torque values for lubricated fasteners.

Proper torque for Metric fasteners.
Recommended torque in Foot Pounds (Newton Meters).*

WRENCH SIZE (mm) "A"	BOLT DIA. (mm) "B"	ASTM 4.6	ASTM 8.8	ASTM 9.8	ASTM 10.9
8	5	1.8 (2.4)		5.1 (6.9)	6.5 (8.8)
10	6	3 (4)		8.7 (12)	11.1 (15)
13	8	7.3 (10)		21.1 (29)	27 (37)
16	10	14.5 (20)		42 (57)	53 (72)
18	12	25 (34)	74 (100)	73 (99)	93 (126)
21	14	40 (54)	118 (160)	116 (157)	148 (201)
24	16	62 (84)	167 (226)	181 (245)	230 (312)
30	20	122 (165)	325 (440)		449 (608)
33	22		443 (600)		611 (828)
36	24	211 (286)	563 (763)		778 (1054)
41	27		821 (1112)		1138 (1542)
46	30	418 (566)	1119 (1516)		1547 (2096)

Mnt-B-0005

INFORMACIÓN DE PARTES

INFORMACIÓN DE PARTES

Las cortadoras RHINO usan balanceadas y componentes de sistema seleccionado para los portadores de cuchillas, cuchillas, eje de cortar, navaja, suspensiones de navajas, los rodillos, los componentes de línea motriz, y cojinetes. Estas partes son echas y probadas a la especificaciones de RHINO. Partes que no son auténticas no regularmente llegan con estas especificaciones. El uso de partes que no son auténticas puede reducir el funcionamiento de la cortadora, anular garantías, y presentar un peligro de seguridad. Use partes de cortadora auténticas de RHINO por economía y seguridad. (SPRM-1 SP)



CONTACTE A SU DISTRIBUIDOR RHINO

NOTA: Para ver las calcomanías en español por favor de referirse a la página 1-20 en la sección de seguridad en inglés.

NOTA: Si necesita un manual completamente en español por favor de ponerse en contacto a: *Translations, dirección 1502 E. Walnut Street Seguin, TX 78155; Fax: (830) 372-9529*

SEGURIDAD

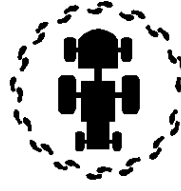
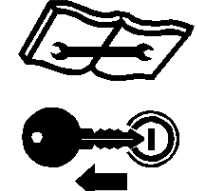
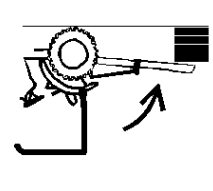
RIESGOS CON EL MANTENIMIENTO DEL IMPLEMENTO

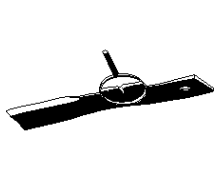
 <p>Inspeccione periódicamente todas las partes móviles, lubrique las líneas de conducción y ajuste todas las sujeciones.</p>	<p>Apague el motor. Quite la llave antes de realizar tareas de mantenimiento.</p> 	<p>Bloquee el implemento antes de repararlo. Utilice bloques grandes sobre suelo blando o húmedo.</p> 	<p>Coloque las trabas de transporte cilíndricas</p> 	<p>Inspeccione las cuchillas para detectar fisuras</p> 
--	--	---	---	--

MANTENGA LOS IMPLEMENTOS EN BUENAS CONDICIONES DE FUNCIONAMIENTO, A TRAVÉS DE UN SERVICIO, REPARACIÓN O MANTENIMIENTO APROPIADO.



ANTES DE REALIZAR TAREAS DE SERVICIO, REPARACIÓN Y MANTENIMIENTO DEL IMPLEMENTO:

- **APAGUE EL MOTOR Y EL PTO,** coloque el freno de mano, descienda el implemento, espere a que se detengan todas las partes móviles y quite la llave antes de bajarse del tractor.
- **COLOQUE** el implemento sobre el suelo o trabe de manera segura los equipos elevados. Utilice bloques grandes sobre suelo blando o húmedo.
- **EMPUJE Y JALE** la palanca del Cilindro Hidráulico Remoto para liberar la presión hidráulica.
- **DESCONECTE** la línea de conducción del **IMPLEMENTO del EJE DE PTO** del tractor.

- **USE GAFAS DE SEGURIDAD Y GUANTES PROTECTORES** y siga todos los **PROCEDIMIENTOS DE SEGURIDAD** al realizar tareas de servicio, reparación y mantenimiento sobre el implemento:
- Siempre **USE GUANTES** protectores al manipular las hojas, cuchillas, bordes filosos o un componente desgastado con bordes filosos.
- Siempre **USE GUANTES Y GAFAS DE SEGURIDAD** al reparar componentes en caliente

- **EVITE EL CONTACTO** con tanques de aceite hidráulico, bombas, motores, válvulas y superficies de conexión de mangueras calientes.
- **SUJETE FIRMEMENTE** o **TRABE EN POSICIÓN ELEVADA** todos los implementos, bastidores y componentes elevados antes de trabajar sobre los equipos que se encuentran debajo.

- **DETENGA** el movimiento de todos los implementos y **APAGUE EL MOTOR DEL TRACTOR** antes de realizar ninguna tarea. **USE** una escalera para alcanzar áreas altas del equipo o las que no se pueda acceder desde la tierra.
- **ASEGURESE** de estar bien apoyado sobre superficies sólidas planas al subirse al implemento para realizar tareas.
- **SIGA** las instrucciones del fabricante sobre como manipular los lubricantes, solventes, limpiadores y otros agentes químicos. **NO** cambie ninguna calibración hidráulica de fábrica para evitar fallas de los componentes o equipos.
- **NO** modifique o altere el implemento, las funciones o componentes.
- **NO SUELDE** o repare los componentes de la cortadora. Esto puede causar vibraciones y fallas de los componentes que se desprendan de la cortadora.

REALICE LAS TAREAS DE SERVICIO, REPARACIÓN, LUBRICACIÓN Y MANTENIMIENTO QUE SE DESCRIBEN EN LA SECCIÓN DE MANTENIMIENTO DEL IMPLEMENTO:



- **INSPECCION** el implemento para detectar sujeciones sueltas, partes gastadas o rotas, ajustes sueltos o con filtraciones, que los pasadores tengan chavetas y arandelas, y las partes móviles para detectar el desgaste.
- **REEMPLACE** todas las partes gastadas o rotas con repuestos autorizados.
- **LUBRIQUE** la unidad tal como se especifica en el cronograma de lubricación.
- **NUNCA** lubrique, ajuste o quite material mientras el equipo está en funcionamiento o movimiento.
- **AJUSTE** todas las tuercas y pernos tal como se especifica.

- **INSPECCION DE CUCHILLAS:**
- **REEMPLACE** las cuchillas dobladas, dañadas, agrietadas o rotas inmediatamente por cuchillas nuevas.
- **EVITE** fallas de las cuchillas y que vuelen trozos de cuchillas. **NO** enderece, suelde o suelde con superficies rígidas.
- **INSPECCION DE PROTECTORES DE SEGURIDAD, GUARDAS Y DISPOSITIVOS DE SEGURIDAD:**
- **MANTENGA** en su lugar y en buen estado todos los defletores, protectores de cadena, protectores de acero, cubiertas de caja de engranajes, cubiertas integrales de PTO, bandas, faldones laterales y zapatas antideslizantes.
- **REEMPLACE** cualquier protector, cubierto o dispositivo de seguridad fallante, roto o gastado.
- El escape del motor, al igual que algunos de sus componentes, y determinados elementos del vehículo contienen o emiten agentes químicos que el estado de California ha determinado que causan cáncer, defectos de nacimiento y otros daños reproductivos.
- Las terminales de baterías y los accesorios relacionados contienen plomo y componentes de plomo, que el estado de California ha determinado son químicos que causan cáncer, defectos de nacimiento u otros daños reproductivos. **PNHM01 SP**

SEGURIDAD

SEGURIDAD

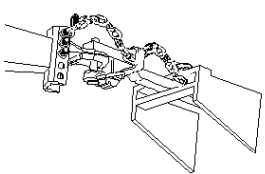
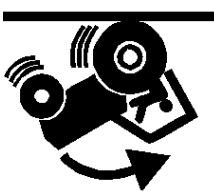
RIESGOS EN TRANSPORTE

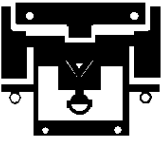
				
Coloque las trabas de transporte	Use la cadena de remolque de seguridad - Tractor a implemento	Peligro de velocidad excesiva por pérdida de control	Peligro de detención por pérdida de control	Use señales de SMV (vehículo de movimiento lento) y balizas

PARA EVITAR LESIONES GRAVES O LA MUERTE AL REMOLCAR O TRANSPORTAR EQUIPOS:



- **MANTENGA** la velocidad de transporte **POR DEBAJO DE 20** millas por hora para mantener el control del equipo.
- **REDUZCA LA VELOCIDAD** en terreno inclinado, en las curvas y en condiciones de remolque desfavorables.
- **NO REMOLQUE** camiones u otros vehículos
- **USE** un tractor de tamaño adecuado y equipado en función del equipo de remolque.
- **SIGA** todas las reglamentaciones de tránsito locales.
- **REQUISITOS DEL TRACTOR PARA REMOLCAR O TRANSPORTAR IMPLEMENTOS:**
- **SOLO TRANSPORTE** en el tractor con el mecanismo **ROPS** (antivuelco) en posición elevada.
- **USE** un tractor de tamaño adecuado y equipado, que supere el peso del implemento en al menos un 20%
- **MANTENGA EL 20%** del peso del tractor en las ruedas frontales para mantener la dirección en forma segura.
- **ANTES DE TRANSPORTAR O REMOLCAR EL IMPLEMENTO:**

- **VERIFIQUE** la dirección y los frenos para asegurarse el correcto funcionamiento y las condiciones adecuadas.
- **VERIFIQUE LLEVAR EL AVISO DE SMV**, los reflectores y las luces de advertencia para la adecuada operación y visibilidad de atrás de la unidad.
- **VERIFIQUE** que no haya impedimentos a la visión mientras conduce, en el tractor, la cabina o el implemento, sentado en el asiento del tractor.
- **AJUSTE** su posición de conducción, los espejos y el transporte del implemento para tener una visión clara para condiciones de conducción y tránsito.
- **PREPARE EL IMPLEMENTO PARA EL TRANSPORTE O EL REMOLQUE:**

- **DESAPLIQUE EL PTO**
- **ELEVE LA CORTADORA**
- **QUITTE** todo material cortado que se acumule en la plataforma de la cortadora.
- **CORTADORA AL REMOLQUE-INSTALE TRABAS DE TRANSPORTE Y CADENA DE SEGURIDAD:**
- **INSTALE** los paradores o pernos de transporte en el cilindro de eje central.
- **AJUSTE LA CADENA DE SEGURIDAD** del implemento al tractor.
- **DETERMINAR LAS CARACTERÍSTICAS DE DETENCIÓN DEL TRACTOR Y EL IMPLEMENTO PARA EL TRANSPORTE O REMOLQUE:**

- **PRUEBAS DE FRENADO:**
- **FRENE** a velocidades en aumento.
- **Observe** las distancias de **DETECCIÓN** con el aumento de velocidad.
- **DETERMINE** la velocidad de transporte máxima segura que no supere las 20 millas por hora
- **DETERMINE LA VELOCIDAD DE GIRO MÁXIMA ANTES DE OPERAR EN CARRETERAS O TERRENO IRREGULAR:**
- **PONGA A PRUEBA** el equipo aumentando lentamente la velocidad en las curvas para determinar si se puede operar a mayor velocidad.
- **USE MENORES** velocidades de giro en las curvas pronunciadas para evitar el vuelco.
- **AL REMOLCAR O TRANSPORTAR EL EQUIPO:**
- Siempre **USE EL CINTURÓN DE SEGURIDAD** al operar o transportar la cortadora.
- **USE** bajas velocidades para evitar el vuelco con el implemento elevado.
- **USE** bajas velocidades y dirección gradual en las curvas, colinas, o en superficies irregulares o poco uniformes, y en carreteras mojadas.
- **ENCIENDA LAS BALIZAS DE ADVERTENCIA** del tractor.
- **TENGA EN CUENTA** el espacio necesario para el vaivén del implemento en las curvas. *PN TH02 SP*

SEGURIDAD

RIESGOS ELÉCTRICOS Y DE FUEGO

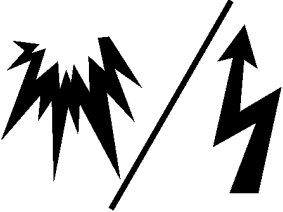
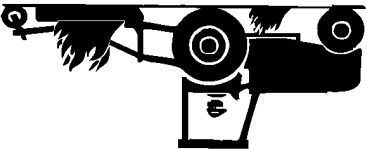
	<p>Riesgo de choque y explosión Contacto de paletas con líneas de servicios o gas</p>
	<p>No opere cerca de fuego. Mantenga limpia la plataforma de la cortadora</p>

PARA EVITAR LESIONES GRAVES O LA MUERTE POR CONTACTO ELÉCTRICO AL TRABAJAR CERCA DE CABLES ELÉCTRICOS, LÍNEAS DE GAS Y DE SERVICIOS:



- **INSPECCIONE** el área de corte para que no interfiera con cables de alimentación eléctricos subterráneos, obstrucciones, líneas de gas, cables y servicios, estructuras municipales o de otro tipo.
- **MANTENGA** todas las alas elevadas a 3 metros (10 pies) o una mayor distancia de todos los cables de alimentación y obstrucciones elevadas.
- **NO** ponga en contacto la cortadora con ninguna estructura u obstrucción de servicios o municipales.
- **LLAME** AL 811 y al 1-800-258-0808 para identificar cables de servicios subterráneos.



PAUTAS DE PREVENCIÓN DE INCENDIOS durante la operación, reparación y servicio de la cortadora y el tractor, a fin de reducir el riesgo de incendio del equipo y de la vegetación:

- El tractor debe estar **EQUIPADO CON MATAFUEGOS**
- **NO OPERE** la cortadora sobre un tractor equipado con escape debajo del bastidor
- **NO FUME** ni acerque fuego directo a la cortadora o el tractor
- **NO CONDUZCA** sobre residuos encendidos o en áreas recientemente quemadas
- **EVITE LA FORMACIÓN DE CHISPAS** al no permitir que la hoja de la cortadora entre en contacto con objetos sólidos como metal o roca.
- **AJUSTE LOS EMBRAGUES DESLIZANTES** para evitar el deslizamiento excesivo y el calentamiento de la placa del embrague.
- **LIMPIE** todo resto de hierba o residuo acumulado alrededor de las líneas de conducción de la cortadora, los embragues deslizantes y cajas de cambios.
- **APAGUE EL MOTOR** al cargar combustible. *PN EF02 SP*

SEGURIDAD

SEGURIDAD

RIESGO DEL CONTACTO A LAS CUCHILLAS DE CORTADORA

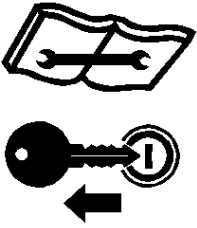
		
No ponga los dedos debajo de la cortadora	No ponga el pie debajo de la cortadora	Detenga el tractor. Quite la llave. Lea el Manual

PELIGRO MANTÉNGASE LEJOS DE LAS CUCHILLAS GIRATORIAS PARA EVITAR LESIONES GRAVES O LA MUERTE POR CONTACTO CON LA CUCHILLA:

- MANTÉNGASE LEJOS y NO ACERQUE LAS MANOS, LOS PIES y EL CUERPO a las cuchillas giratorias, líneas de conducción y partes hasta que todos los elementos móviles se hayan detenido.
- NO ponga las manos o los pies debajo de las plataformas de la cortadora
- DETENGA las CUCHILLAS giratorias antes de elevar la plataforma de la cortadora o las alas
- DETENGA la cortadora, EXAMÍNELA y PRESTE ATENCIÓN A LOS SONIDOS antes de acercarse a la cortadora para asegurarse de que se haya detenido todo el movimiento giratorio. *PN MB01 SP*

RIESGO DE FILTRACION DE ACEITE HIDRÁULICO DE ALTA PRESIÓN

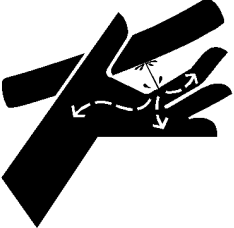
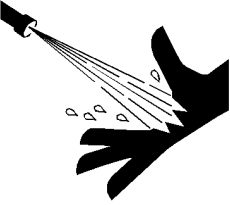
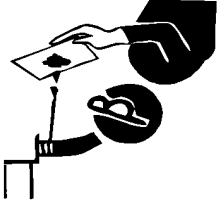
		
High pressure oil penetrating skin	High pressure oil eroding skin	Using cardboard to check for oil leaks

PELIGRO PARA EVITAR LESIONES GRAVES O LA MUERTE POR PENETRACIÓN DE FILTRACIONES DE ACEITE HIDRÁULICO DE ALTA PRESIÓN:

- NO OPERE el equipo con filtraciones de aceite o combustible.
- MANTENGA todas las mangueras hidráulicas, líneas y conexiones en BUEN ESTADO y AJUSTADAS antes de aplicar presión al sistema.
- LIBERE LA PRESIÓN HIDRÁULICA antes de desconectar las líneas o trabajar en el sistema.
- QUITE y reemplace la manguera si sospecha que tiene filtraciones. Solicite al distribuidor que verifique si hay filtraciones.



LAS FILTRACIONES DE LÍQUIDO DE ALTA PRESIÓN PUEDEN NO SER VISIBLES.

AL VERIFICAR FILTRACIONES HIDRÁULICAS Y TRABAJAR CERCA DE LOS SISTEMAS HIDRÁULICOS:

- SIEMPRE USE gafas de seguridad y guantes impermeables.
- USE papel o cartón para verificar si hay filtraciones.
- NO USE las manos o partes del cuerpo para detectar filtraciones.
- MANTENGA las manos y el cuerpo LEJOS de los orificios de clavijas y boquillas de eyección de fluido hidráulico. El fluido hidráulico puede causar gangrena si no es extraído quirúrgicamente de inmediato por un médico especializado en este tipo de lesiones. *PN HP01 SP*

SEGURIDAD

RIESGO DE ENREDO POR EL PTO

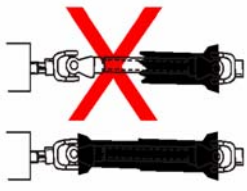
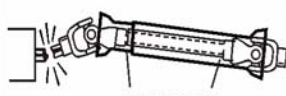
<p>Peligro de enredo No se acerque o toque ningún eje de transmisión de PTO giratorio</p>	
<p>Asegúrese de que el eje de PTO esté firmemente sujetado. No use un adaptador de PTO</p>	
<p>No opere la máquina si las cubiertas de PTO están dañadas o faltantes</p>	
<p>Asegúrese de que los ejes de PTO sean del largo adecuado</p>	

▲ PELIGRO MANTÉNGASE ALEJADO DE LAS LÍNEAS DE CONDUCCIÓN Y OTROS ELEMENTOS GIRATORIOS PARA EVITAR LESIONES GRAVES O LA MUERTE:

MANTÉNGASE LEJOS Y NO ACERQUE las manos, los pies y el cuerpo a las cuchillas giratorias, líneas de conducción y partes hasta que todos los elementos móviles se hayan detenido.

- **DETENGA** la cortadora, **EXAMÍNELA Y PRESTE ATENCIÓN A LOS SONIDOS** antes de acercarse a la cortadora para asegurarse de que se haya detenido todo el movimiento giratorio.
- **LOS ELEMENTOS GIRATORIOS SIGUEN ROTANDO** una vez apagada la PTO.

PROTECCIÓN DE LA PTO:

PARA EVITAR LESIONES GRAVES O LA MUERTE POR ENREDO AL OPERAR EL IMPLEMENTO:

- **MANTENGA** instalados los protectores, las cubiertas integrales de las líneas de conducción y las cubiertas de entrada
- **NO OPERE** la cortadora si los protectores o cubiertas no están bien colocados o faltan.
- **REEMPLACE O REPARÉLOS** si faltan, están dañados o rotos
- **SIEMPRE REEMPLACE LOS PROTECTORES** que se han quitado para tareas de reparación o mantenimiento.

PARA EVITAR que la línea de conducción se rompa durante las operaciones:

- **VERIFIQUE** que la línea de conducción tenga el largo adecuado entre el eje de PTO y el eje de la caja de cambios del implemento.
- Las líneas de conducción demastado cortas se pueden soltar o romper.
- Las líneas de conducción demastado largas pueden tocar el suelo.
- Un ensamblaje telescópico de la línea de conducción que toque el suelo no se deslizará y se solidificará.
- Si la línea de conducción toca el suelo, puede atravesar los cojinetes de soporte y romper el eje de PTO.
- **EVITE** hacer curvas pronunciadas o elevar la cortadora a alturas que puedan hacer caer la línea de conducción.
- Lubrique los componentes telescópicos del eje de transmisión en forma semanal.

COMUNIQUESE CON EL DISTRIBUIDOR si la línea de conducción del implemento no coincide con el eje de PTO del tractor:

- **NO UTILICE UN ADAPTADOR DE PTO.**

El uso de un adaptador de PTO puede causar vibración excesiva, caída de objetos, fallas de las cuchillas y el implemento como consecuencia de la duplicación de la velocidad operativa. El aumento de la longitud de trabajo puede exponer áreas desprotegidas de la línea de conducción. *PN PE01 SP*

SEGURIDAD

RIESGO DE ATRAPELLO

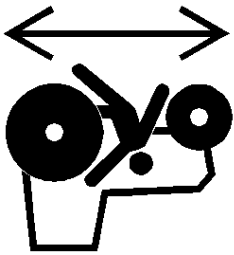
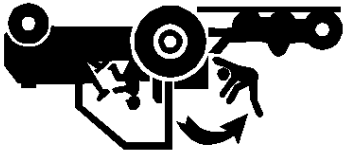

		
<p>Riesgo de atrapello del operador</p>	<p>Riesgo de atrapello por caída del operador</p>	<p>Riesgo de atrapello por caída del operador</p>

PELIGRO PARA EVITAR LESIONES GRAVES O LA MUERTE POR CAÍDA DEL TRACTOR O ATRAPELLO DEL EQUIPO:

- USE tractores equipados con SISTEMA ANTIVUELCO (ROPS) y CINTURONES DE SEGURIDAD para las operaciones de corte.
 - MANTENGA EL SISTEMA ROPS trabado en posición vertical.
 - SÓLO ENCIENDA el tractor sentado en el asiento del tractor.
 - SIEMPRE ABROCHESE el cinturón de seguridad al operar el tractor y los equipos.
 - SÓLO OPERE el tractor y el equipo sentado en el asiento del tractor.
 - NUNCA LLEVE A OTRAS PERSONAS en el tractor o implemento.
- AL SUBIR Y BAJAR DEL TRACTOR:**
- SÓLO suba o baje del tractor cuando éste y sus partes móviles estén detenidos.
 - APAGUE EL MOTOR Y LA TDF, coloque el freno de mano, descienda del implemento, espere a que se detengan todas las partes móviles y quite la llave antes de bajarse del tractor. *PN R001 SP*

SEGURIDAD

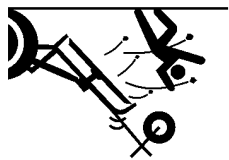
RIESGO DE OBJETOS LANZADOS Continuado

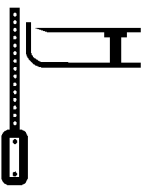
	<p>Peligro de objetos lanzados por la cortadora</p>	<p>Objetos lanzados desde cortadora elevada</p> 	<p>Inspeccione el área. Quite los objetos extraños</p> 
<p>No permita que las cuchillas entren en contacto con objetos sólidos</p> 	<p>AJUSTE las secciones de la cortadora o la ala cercana y paralela al suelo sin exponer las cuchillas</p>	<p>AJUSTE LA ALTURA de corte para EVITAR EL CONTACTO DE LAS CUCHILLAS con objetos sólidos, como alambres, piedras, postes, cordones, guardarrailles y obstrucciones fijas.</p>	<p>NO opere la cortadora con la(s) al(a)s elevada(s) o en posición de transporte.</p>

OPERACIÓN DE LA CORTADORA:

- NO exceda la capacidad de corte nominal de la cortadora, ni corte elementos que no sean vegetación.
- USE CABINAS DE TRACTOR CERRADAS cuando haya dos o más cortadoras operando en un mismo sector.

- AJUSTE las secciones de la cortadora o la ala cercana y paralela al suelo sin exponer las cuchillas
- AJUSTE LA ALTURA de corte para EVITAR EL CONTACTO DE LAS CUCHILLAS con objetos sólidos, como alambres, piedras, postes, cordones, guardarrailles y obstrucciones fijas.
- NO opere la cortadora con la(s) al(a)s elevada(s) o en posición de transporte.
- DETENGA LA CORTADORA de inmediato si las cuchillas entran en contacto con objetos pesados, estructuras fijas, guardarrailles de metal y estructuras de cemento:

1. LAS CUCHILLAS PUEDEN FALLAR con el impacto y los objetos pueden ser arrojados a gran velocidad.
2. INSPECCIONE y REEMPLACE las cuchillas dañadas.
3. VERIFIQUE el equilibrio del porta cuchillas y REEMPLACELO si está dañado.

- NO opere la cortadora en agua PARA EVITAR una posible FALLA DE LAS CUCHILLAS.
- EVITE OPERAR LA CORTADORA en reversa:

1. DETENGA EL PTO y retroceda la cortadora.
2. DESCienda la cortadora, encienda el PTO y corte hacia adelante.

- DETENGA EL PTO y las CUCHILLAS al elevar el implemento o la cortadora a posición de transporte.
- NO ENCienda EL PTO con la cortadora en posición de transporte.

- DETENGA la cortadora cuando se produzca VIBRACIÓN EXCESIVA:

1. DETENGA EL PTO Y EL MOTOR del tractor.
2. INSPECCIONE la cortadora para detectar la fuente de la vibración
3. REEMPLACE toda parte dañada o las CUCHILLAS dobladas o dañadas. PN T002-X-SP

SEGURIDAD

SEGURIDAD

RIESGO DE OBJETOS LANZADOS

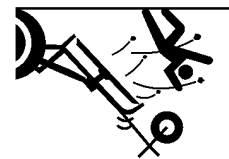
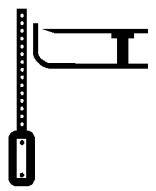
 <p>Peligro de objetos lanzados por la cortadora</p>	 <p>Objetos lanzados desde cortadora elevada</p>	 <p>Inspeccione el área. Quite los objetos extraños</p>	 <p>No permita que las cuchillas entren en contacto con objetos sólidos</p>
---	--	--	--

▲ PELIGRO LAS CORTADORAS GIRATORIAS PUEDEN ARROJAR OBJETOS A 90 METROS (300 PIES) O MÁS EN CONDICIONES ADVERSAS.

PARA EVITAR LESIONES GRAVES O LA MUERTE AL OPERADOR O TRANSEÚNTES COMO CONSECUENCIA DE OBJETOS ARROJADOS:



- MANTENGA a los transeúntes a 100 metros de distancia (300 pies)
- NO OPERE LA CORTADORA SI HAY PERSONAS A MENOS DE 100 METROS(300 PIES), SALVO QUE:
 - Todos los **PROTECTORES CONTRA OBJETOS ARROJADOS** estén colocados y en buen funcionamiento al operar la cortadora, entre los que se incluyen los deflectores frontales y traseros, los protectores de cadena, los protectores de acero, las bandas, los faldones laterales y las zapatas antideslizantes.
 - Las partes de la cortadora o la aia estén ajustadas cerca y paralelas al suelo, sin exponer las cuchillas.
 - Se ha inspeccionado el **ÁREA DE CORTE** y se han quitado todos los materiales extraños y residuos.
 - **LOS TRANSEÚNTES** estén en el interior de un vehículo cerrado.
- **ANTES DE OPERAR LA CORTADORA, INSPECCIONE EL ÁREA PARA DETECTAR LA POSIBILIDAD DE OBJETOS QUE PUEDAN SER LANZADOS:**
 - **QUITE** residuos, piedras, cables, alambres, objetos metálicos y cualquier otro objetos extraños del área.
 - Los alambres, cables, sogas, cadenas y objetos metálicos pueden ser arrojados o salir desprendidos de la plataforma a gran velocidad:

1. **MARQUE** los objetos que no se puedan quitar.
 2. **EVITE** estos objetos cuando use la cortadora.
- INSPECCIÓN DEL ÁREA PARA DETECTAR HIERBA ALTA Y MALEZAS:**
- **INSPECCIONE Y QUITE** cualquier residuo oculto de gran tamaño.
 - **PASE LA CORTADORA** a una altura intermedia
 - **INSPECCIONE** y quite el residuo restante
 - **PASE LA CORTADORA** a la altura final
- PROTECCIÓN CONTRA OBJETOS ARROJADOS DE LA CORTADORA:**
- **MANTENGA** todos los protectores contra objetos arrojados en su lugar y en buen funcionamiento al operar la cortadora, entre los que se incluyen los deflectores frontales y traseros, los protectores de cadena, los protectores de acero, las bandas, los faldones laterales y las zapatas antideslizantes.
 - **NO OPERE LA CORTADORA** si falta algún protector contra objetos arrojados, o si éstos están dañados.

- **DERECHO DE PASO (autopistas) CON LA CORTADORA** para autopistas, derecho de paso, parques o cortes en cinturón verde donde pueda haber viviendas, vehículos o ganado dentro de los 100 metros (300 pies) de la cortadora. Para reducir la posibilidad de que se produzcan lesiones:
 1. **MANTENGA LOS PROTECTORES DE LA CORTADORA**, los faldones laterales, las zapatas antideslizantes y las cuchillas en buen estado de funcionamiento,
 2. **ELEVE LA ALTURA DE CORTE a 15 CM (6 PULGADAS)** como mínimo,
 3. **INSPECCIONE EL ÁREA** con cuidado antes de pasar la cortadora para **ELIMINAR** el posible riesgo de **OBJETOS ARROJADOS**,
 4. **NUNCA PERMITA QUE LAS CUCHILLAS EN MOVIMIENTO ENTREN EN CONTACTO CON OBJETOS SÓLIDOS** como alambres, piedras, postes, cordones, guardarraíles o el suelo. **PN 1002 SP**

SEGURIDAD

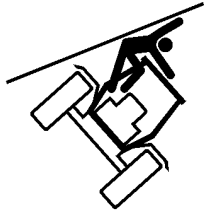
RIESGO DE APLASTAMIENTO

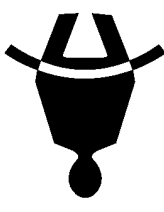
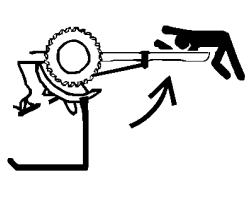
	Lesión aplastante por vuelco
	Trabe el sistema ROPS (antivuelco) en la posición vertical
	Siempre utilice cinturón de seguridad
	Lesión aplastante por caída de implemento

PELIGRO PARA EVITAR UNA LESIÓN GRAVE O LA MUERTE POR CAÍDA DEL TRACTOR, O EL APLASTAMIENTO, VUELCO Y APLASTAMIENTO DE UN EQUIPO POR LA CAÍDA DE UNA ALA O UN IMPLEMENTO:

- USE tractores equipados con SISTEMA ANTIVUELCO (ROPS) y CINTURONES DE SEGURIDAD para las operaciones de corte.
- MANTENGA EL SISTEMA ROPS trabado en posición vertical.
- SIEMPRE ABRÓCHESE el cinturón de seguridad al operar el tractor y los equipos.
- SOLO OPERE el tractor y el equipo sentado en el asiento del tractor.
- AL ELEVAR O DESCENDER EL IMPLEMENTO:

- Eleve o descienda SÓLO CUANDO ESTÉ SENTADO en el asiento del tractor, con el cinturón de seguridad ajustado.
- Eleve o descienda SÓLO cuando la lengüeta del implemento esté firmemente ajustada a la barra de tracción del tractor.
- MANTENGA A LOS TRANSASENTES FUERA del área de operación PARA EVITAR accidentes por aplastamiento.
- Los equipos ELEVADOS se pueden caer por fallas mecánicas o hidráulicas o por un movimiento inesperado de la palanca de control.

ADVERTENCIA PARA EVITAR LA CAÍDA DEL EQUIPO al trabajar cerca o debajo de los componentes o implementos elevados por un enganche de tractor de 3 puntos:

- SUJETE CON FIRMEZA o bloquee en posición vertical todos los equipos, alas y componentes elevados.
- BLOQUEE EN POSICIÓN VERTICAL y sujete con firmeza el equipo antes de poner las manos, los pies o el cuerpo debajo de los equipos o componentes elevados.
- AL ESTACIONAR el implemento y el tractor:

- NUNCA deje un implemento sin atención en posición elevada.
- DESCienda el implemento, TRABE o BLOQUEE las partes elevadas antes de alejarse del equipo.

ADVERTENCIA PARA EVITAR LA CAÍDA O EL APLASTAMIENTO DE NIÑOS POR EL EQUIPO:

- NUNCA DEJE que los niños jueguen sobre el tractor o los implementos, ni en sus alrededores.
- WHEN UNHITCHING IMPLEMENT:
- AL DESENGANCHAR EL IMPLEMENTO:
- DESCienda el implemento, TRABE o BLOQUEE las partes elevadas antes de alejarse del equipo.
- USE el gato de la lengüeta para controlar el movimiento de la lengüeta del implemento
- USE el GATO de la lengüeta para elevar lengüetas de implementos pesados.
- EVITE recargar el gato para evitar falla al gato y una lesión al operador. *PN CH02 SP*

SEGURIDAD

SEGURIDAD DE CONECTAR O DESCONECTAR IMPLEMENTO

 <p>Detenga el tractor Quite la llave Lea el Manual</p>	 <p>Lesión opresiva entre tractor e implemento</p>	 <p>PTO (Barra Gítoria)</p> <p>Asegúrese de que el eje de TDF esté firmemente ajustado al tractor</p>	 <p>Asegúrese de que el eje de TDF sea del largo adecuado</p>
--	--	--	--

▲ PELIGRO PARA EVITAR LESIONES GRAVES O LA MUERTE POR APLASTAMIENTO POR EL TRACTOR O IMPLEMENTO:

- **AL DAR MARCHA ATRÁS** el tractor hacia el enganche del implemento:
- **NO PERMITA QUE HAYA PERSONAS** entre el tractor y el implemento
- **ANTES de conectar y desconectar el enganche del implemento:**
 - **APAGUE EL MOTOR DEL TRACTOR**, coloque la palanca en "estacionar", ponga el freno de mano y saque la llave.

Al conectar y desconectar el enganche del implemento:

- **NO** se agache o camine debajo de la cortadora o la ala en posición elevada.
- **USE** el **GATO** con lengüeta para elevar lengüetas de implementos pesados a fin de controlar el movimiento de la lengüeta del implemento.
- **EVITE** recargar el gato para evitar una falla de este y una lesión al operador.

AL CONECTAR LA LÍNEA DE CONDUCCIÓN DEL IMPLEMENTO:

PARA EVITAR que la línea de conducción del implemento se suelte durante la operación:

- **LUBRIQUE** el anillo de cierre del resorte del yugo para asegurarse de que se deslice libremente sobre el eje de **PTO**
- **ASEGURE** las bolas de cierre del yugo en la muesca del eje de **PTO**.
- **PRESIONE Y JALE DE LA LÍNEA DE CONDUCCIÓN del EJE DE TOMA DE FUERZA(PTO)** del tractor y del implemento para asegurarse de que estén **FIRMEMENTE SUJETADOS**

PARA EVITAR que la línea de conducción se rompa durante las operaciones:

- **VERIFIQUE** que la línea de conducción tenga el largo adecuado entre el eje de **PTO** y el eje de la caja de cambios del implemento.
- Las líneas de conducción demastado cortas se pueden soltar o romper.
- Las líneas de conducción demastado largas pueden tocar el suelo.
- Un ensamblaje telescópico de la línea de conducción que toque el suelo no se deslizará y se solidificará.
- Si la línea de conducción toca el suelo, puede atravesar los cojinetes de soporte y romper el eje de **PTO**.





COMUNIQUESE CON EL DISTRIBUIDOR si la línea de conducción del implemento no coincide con el eje de TDF del tractor:

- **NO UTILICE UN ADAPTADOR DE PTO.**
- El uso de un adaptador de **PTO** puede ocasionar:
 - Vibración excesiva, caída de objetos, fallas de la hoja y el implemento como consecuencia de la duplicación de la velocidad operativa.
 - Mayor extensión de trabajo, lo que deja expuestas áreas desprotegidas de la línea de conducción e implica el riesgo de enredo con otros objetos.

NO conecte la cortadora a un tractor con la TDF directamente conectada a la transmisión del tractor. PN CD02 SP

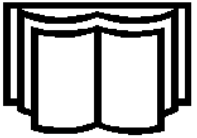
SEGURIDAD

SEGURIDAD DEL OPERADOR

	Lea con atención el Manual del Operador
	Siempre use gafas de seguridad
	Use casco y calzado protector
	Nunca consuma drogas o alcohol mientras opera el equipo
	Utilice chaleco de seguridad al operar en o cercas de carreteras

PARA EVITAR LESIONES GRAVES O LA MUERTE, SIGA LAS SIGUIENTES INSTRUCCIONES:



- **LEA, COMPRENDA Y SIGA** las instrucciones del Manual del Operador, al igual que las Advertencias y Mensajes de Seguridad.
- **USE GAFAS DE SEGURIDAD**, calzado protector, casco, protección auditiva y guantes al operar o reparar el equipo
- **USE** un aparato de respiración apropiado al operar en condiciones polvorientas a fin de evitar contraer enfermedades respiratorias.
- **NO USE** prendas sueltas o joyas que se puedan enredar con las partes giratorias y causar una lesión.
- **NO CONSUMA DROGAS** o **ALCOHOL** antes o durante la operación del equipo.
- **NO PERMITA** que nadie opere el equipo bajo los efectos negativos de las drogas o el alcohol.
- **CONSULTE** a un médico para conocer los efectos desfavorables de la medicación sobre los sentidos.
- **MANTÉNGASE ALERTA**, la operación prolongada puede causar fatiga. **HAGA UNA PAUSA Y DESCANSE**.

SEGURIDAD DE OPERACIÓN GENERAL

- **CONDICIONES DE VISIBILIDAD AL USAR LA CORTADORA:**
 - **OPERE LA CORTADORA CON LUZ SOLAR** o con luz que aporte una visibilidad nítida de más de 90 metros (100 yardas).
 - **DEBE PODER VISUALIZAR** e identificar transeúntes, terrenos empinados, pozos, desniveles, obstrucciones elevadas, cables de alimentación, residuos y objetos extraños.
- **VELOCIDAD RESPECTO AL SUELO AL USAR LA CORTADORA:**
 - El rango de **VELOCIDAD NORMAL** es de entre 2 y 5 millas por hora.
 - **AJUSTE LA VELOCIDAD DE CORTE** según las condiciones del terreno y el tipo de césped, la densidad y la altura del corte.
 - **REDUZCA LA VELOCIDAD DE CORTE** al acercarse a inclinaciones empinadas, pozos, desniveles, obstrucciones elevadas, cables de alimentación y para evitar residuos y objetos extraños.
- **INFESTACIÓN CON INSECTOS**
 - No opere en áreas susceptibles al ataque de abejas o insectos, salvo que **USE PRENDAS PROTECTORAS** o una cabina de tractor cerrada.
- **VELOCIDAD DE PTO:**
 - **NO EXCEDA LA VELOCIDAD DE PTO NOMINAL DEL IMPLEMENTO**
 - **EVITE** superar las velocidades nominales de PTO, porque puede causar roturas en la línea de conducción o fallas de las cuchillas.
- **SEÑALES DE SEGURIDAD:**
 - **REEMPLACE** cualquier señal de seguridad faltante, dañada o ilegible. *PN OS01 SP*

SEGURIDAD

SEGURIDAD

INSTRUCCIONES DE SEGURIDAD Y PRÁCTICAS GENERALES

El mejor operador es un operador cuidadoso. La seguridad es de importancia fundamental para el fabricante, y también debería serlo para el propietario u operador. La mayoría de los accidentes se pueden evitar prestando suma atención al equipo, al ambiente circundante, y tomando algunas precauciones. La primera sección de este manual incluye una lista de Mensajes de Seguridad que deben observarse para contribuir a la protección del operador y otras personas frente a lesiones o la muerte. Lea con atención estos Mensajes de Seguridad antes de ensamblar, operar o reparar este implemento. Este equipo sólo debe ser operado por personas que hayan leído el manual, responsables y calificadas, que sepan cómo hacerlo de manera responsable.



El Símbolo de Alerta de Seguridad se utiliza en combinación con una Señal Verbal, tal como la que se muestra a continuación, en todo este manual y en los autoadhesivos adheridos a los equipos. El Símbolo de Alerta de Seguridad significa:

“¡ATENCIÓN! MANTÉNGASE ALERTA! SU SEGURIDAD ESTÁ EN JUEGO!” El Símbolo y la Señal Verbal tienen el objetivo de advertir al propietario/operador sobre un riesgo inminente y el grado de lesión que se puede producir al operar este equipo.

Adopte todas las medidas habituales para trabajar en forma segura y, sobre todo, recuerde que la seguridad depende de USTED. Sólo USTED puede impedir una lesión grave o la muerte a causa de prácticas no seguras.

Indica una situación peligrosa inminente que, de no ser evitada, **OCCASIONARÁ** la **MUERTE O UNA LESIÓN MUY GRAVE.**



Indica una situación peligrosa inminente que, de no ser evitada, **PODRÍA OCCASIONAR** la **MUERTE O UNA LESIÓN MUY GRAVE.**



Indica una situación peligrosa inminente que, de no ser evitada, **PODRÍA OCCASIONAR** **UNA LESIÓN MENOR.**



Identifica instrucciones o procedimientos específicos que, de no observarse estrictamente, podrían ocasionar daños o la destrucción de la maquinaria, los accesorios o el entorno.



NOTA: Identifica aspectos de particular interés para lograr una operación o reparación más eficiente y conveniente.



LEA CON ATENCIÓN Y RESPETE los siguientes Mensajes de Seguridad. Si no se siguen cuidadosamente las advertencias e instrucciones indicadas en este Manual y en los Mensajes de Seguridad del implemento, se pueden producir lesiones graves o la muerte. Siempre siga las instrucciones de este manual y use el sentido común para evitar situaciones peligrosas.

NOTA: Si desea obtener una traducción de esta sección de seguridad en alguno de los siguientes idiomas, comuníquese con: *Translations, a la dirección 1502 E. Walnut Street Seguin, TX 78155; Fax: (830) 372-9529; La Sección de Seguridad de esta disponibilidad en español, portugués, francés, alemán, ruso. PN 6501 SP*

SECCIÓN DE SEGURIDAD

Sección de Seguridad 1-1

INSTRUCCIONES DE OPERACIONES ANTES DE LA ENTREGA DEL DISTRIBUIDOR AL CLIENTE

El distribuidor deberá informar al comprador de este producto las condiciones, disposiciones y procedimientos de garantía aplicables; informar la responsabilidad del comprador de capacitar a sus operadores para la operación segura; revisar el contenido del Manual del Operador, incluido el equipo de seguridad, la operación segura y el mantenimiento; y revisar las Señales de Seguridad que se encuentran en el implemento (y en el tractor, de ser posible).

- **IMPLEMENTOS:** He explicado que los deflectores, protectores de cadena o faldones sólidos se deben mantener en buenas condiciones de reparación y se deben instalar, excepto en zonas donde personas, vehículos, ganado u otros bienes no corran peligro por objetos arrojados, y en los casos en que dichos equipos de seguridad impedirían un desempeño razonable de la cortadora en su tarea asignada.

- **LÍNEAS DE CONDUCCIÓN:** Me he asegurado de que todos los protectores de líneas de conducción, de caja de engranajes y otros están en buenas condiciones de reparación y firmemente sujetos para prevenir lesiones por enredo u objetos arrojados.

- **MÁQUINAS HIDRÁULICAS:** He explicado la necesidad de usar aceite hidráulico limpio, cambiar los filtros según las instrucciones, detener filtraciones, prevenir daños por operar con aceite demasado caliente, cuidar las mangueras, usar mangueras del tipo correcto, mantener la presión operativa especificada y prevenir el posible riesgo de que el aceite penetre en la piel.

- **IMPLEMENTOS PLEGABLES:** He explicado que no es posible proteger contra objetos arrojados cuando el cabezal está elevado del suelo y que el operador es responsable de verificar que no existan personas en las inmediaciones. He explicado que el brazo o cabezal de cortadora elevado puede entrar en contacto con obstrucciones elevadas y dañar cables y líneas telefónicas, y posiblemente causar lesiones. He explicado que el brazo o cabezal extendido, o el brazo retirado, puede entrar en contacto con cables de alimentación y causar lesiones o la muerte por electrocución, y que el operador es responsable de evitar dichos riesgos.

SERVICIO ANTES DE LA ENTREGA VERIFIQUE Y AJUSTE O LUBRIQUE SEGUN SEA NECESARIO

Consulte los detalles en el Manual del Operador
Inspección realizada – Garantía y procedimientos de seguridad explicados – Instalación realizada

CONEXIONES DE CORTADORA A TRACTOR

- Longitud de barra de enganche (verificar y fijar)
- Pivote y conexiones de bastidor en A
- Barras de control (ajustadas iguales)
- Altura de eje (ajustar)
- Altura de corte (ajustar)
- Verificación de pre-operación de kit de montaje
- Aleta de cortadora (ajustar nivel con el centro)
- Aleta de cortadora (verificar operación de elevación correcta)
- Líneas de conducción C.V. (verificar radio de giro máx.)
- Enganche de tracción (ajuste de altura)
- Piezas metálicas de montaje bien ajustadas

ELEMENTOS DE SEGURIDAD

- Protectores (operación e instalación)
- Embrague de línea de conducción (limitador de ajuste)
- (ajustar y poner en marcha)
- Autoadhesivos de seguridad (colocados)
- Manual del Operador (entregado)
- Protector de TDF del tractor (instalado)
- Emblema S.M.V. (instalado de ser necesario)
- Gato con lengüeta (instalación y operación)
- Cadena de remolque de seguridad (instalada)
- Manual de Seguridad de Línea de Conducción ADMA (entregado)
- Manual de Seguridad de Cortadora AEM (entregado en porta manual)
- Se mostró el Video de Seguridad de Cortadora AEM al comprador

LUBRICACIÓN E HIDRÁULICA

- Caja de engranajes (niveles de aceite)
- Nivel de aceite hidráulico (tanque externo)
- Nivel de aceite hidráulico del tractor
- Mangueras hidráulicas (no retorcidas y ajustadas)
- Propulsor de bomba frontal (conjunto ajustado y eje bien alineado)

CORTADORA

- Pernos de husillo y motor bien ajustados
- Nivel de aceite del husillo
- Pernos de porta cuchillas bien ajustados/pasadores de retención colocados
- Nivel y altura de corte de la cortadora ajustados
- Cojinetes del eje de corte lubricados
- Todas las piezas metálicas bien ajustadas
- Presión de aire y neumáticos/tuercas de rueda (bien ajustadas)
- Cojinetes de rueda (verificar, engrasar y hacer carga previa)

ACCESORIOS E INSTALACIÓN

- Deflectores frontales y traseros
- Accesorios de trituración
- Sentido de giro de las hojas correcto
- Vigas y brazos de eje
- Lengüeta y barras de control (instaladas y ajustadas)
- Todos los pernos, pasadores y tuercas (ajuste correcto)

Alamo Group Ag. Division está dispuesto a suministrar un (1) Video de Prácticas de Seguridad para Cortadoras AEM

Por favor enviar: Video de Seguridad para el Operador de Cortadoras AEM/FEMA – formato VHS

Video de Seguridad para el Operador de Cortadoras AEM/FEMA – formato DVD

Manual del Operador de la Cortadora

Manual de Seguridad del Operador de la Cortadora AEM

Nombre del solicitante: _____ Teléfono: _____

Dirección del solicitante: _____

Ciudad _____

Estado _____

Código postal _____

Modelo de cortadora: _____ Número de serie: _____

Fecha de compra: _____ Vendedor del distribuidor: _____

Nombre del distribuidor: _____ Dirección del distribuidor: _____

Enviar por correo a:

AEM Video Services

1502 E. Walnut Street

Seguin, TX 78155

enviar por fax a:

(830) 372-9529

enviar por correo electrónico a:

AEMVideo@alamo-group.com

Video de cortadora AEM

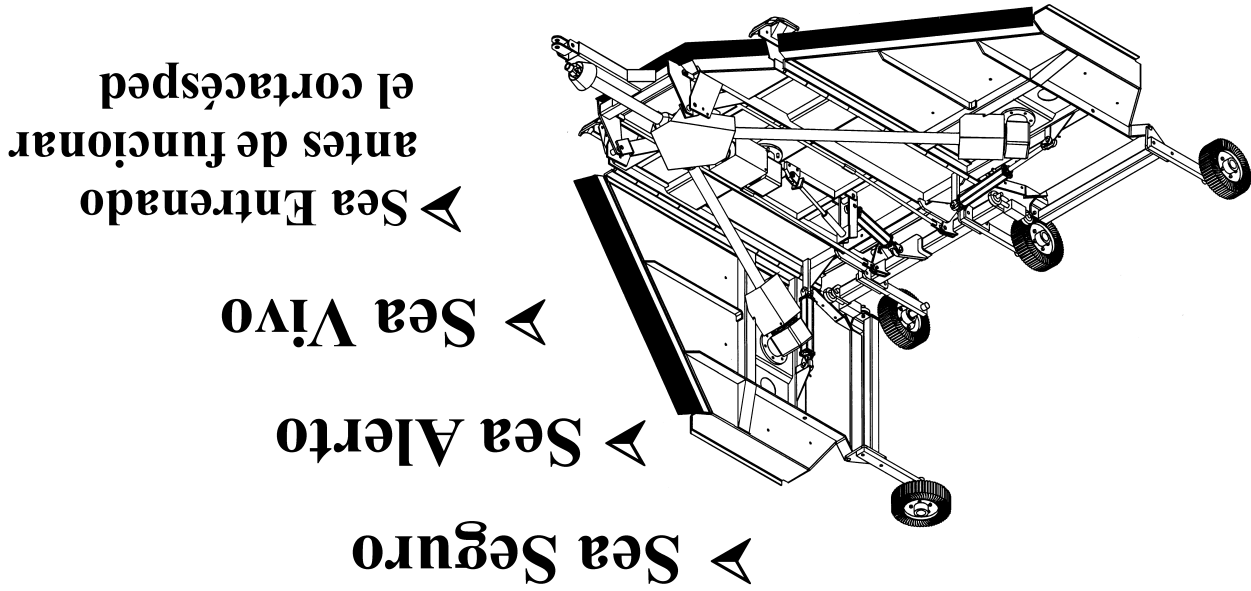

- **Sea Seguro**
- **Sea Alerto**
- **Sea Vivo**
- **Sea Entrenado**
- antes de funcionar**
- el cortacésped**

Entrenamiento de Seguridad

Hace la Diferencia



Al Image SP

A fin de reducir la tasa de accidentes y mejorar la operación segura de las cortadoras, Alamo Group Ag Division se ha asociado con otros fabricantes de la industria para desarrollar el video y la guía de Prácticas de Seguridad para Cortadoras Industriales y Agrícolas AEM/FEMA.

El video explica a los operadores de tractores y cortadoras las prácticas seguras que deben adoptar cuando utilizan cortadoras industriales y agrícolas. Es importante que todos los operadores de cortadoras aprendan cómo operar sus equipos de corte y puedan reconocer los posibles peligros que pueden surgir al operar una cortadora. Este video, en conjunto con el manual del operador de la cortadora y los mensajes de advertencia que se encuentran en la cortadora, serán muy útiles para complementar este aprendizaje tan importante.

Es posible que su distribuidor autorizado de Rhino le haya mostrado este video y le haya entregado una copia en DVD cuando adquirió su cortadora. Si usted o algún operador de cortadora no vio el video, mire el video, lea este Manual del Operador, y complete la Guía del Video antes de operar su cortadora nueva. Si no comprende alguna de las instrucciones del video o del manual del operador, o si tiene alguna pregunta acerca de la operación segura, comuníquese con su supervisor, con el distribuidor o con Alamo Group Ag. Si desea recibir una copia del video en VHS, envíe un mensaje de correo electrónico a AEMVideo@alamo-group.com o un fax al (830) 372-9529, o envíe por correo una copia rellena del formulario que se encuentra al dorso de esta página a AEM VHS Video 1502 E Walnut Street, Seguin, TX 78155, y solicite la versión en VHS. Indique su nombre, dirección postal, modelo de cortadora y número de serie.

Cada uno de los operadores debe recibir capacitación para cada equipo (tractor y cortadora), comprender el uso previsto, y comprender los posibles peligros antes de operar el equipo. La información y material mecionado en la información anterior junto con el Manual de Operador puede asistir en cumplir con los requisitos de OSHA para el entrenamiento anual del Operador.

REQUISITOS DE ENTRENAMIENTO DEL OSHA

Los siguientes requisitos de entrenamiento se an tomada del Título 29, código de la pieza de regulaciones federales 1928.57 (a) (6). www.osha.gov

Instrucciones del operador. A la hora de la asignación inicial y por lo menos anualmente después de eso, el empleador mandará a cada empleado quien opera un tractor agrícola o implemento en las practicas de operación segura y el mantenimiento de el equipo con el cual el empleado este, o estará implicado y de cualquier otras prácticas dictados por el ambiente laboral.

Al propietario/operador/distribuidor

Este Manual del Operador es una parte esencial de la operación segura de esta máquina y se debe mantener con la unidad siempre. El implemento incluye un porta manual donde se puede guardar el manual de manera adecuada. Si el manual se extravía o se daña, puede solicitar otra copia sin cargo a un distribuidor autorizado de Rhino o descargarlo del sitio web de Rhino (www.servis-rhino.com).

ANTES DE COMENZAR LEA, COMPRENDA Y SIGA la información incluida en este manual, el Manual de Seguridad de la Cortadora AEM y el manual del operador del tractor para conocer cómo operar la máquina y realizar tareas de servicio correctamente. De lo contrario, podría sufrir lesiones u ocasionar lesiones a terceros. Todos los implementos con partes móviles son potencialmente peligrosos. Cada esfuerzo ha sido hecho para asegurar que la máquina esté segura, pero los operadores deben evitar entrar en prácticas peligrosas y seguir las instrucciones escritas que son proporcionadas. El fabricante ha diseñado este implemento para ser usado con todos sus equipos de seguridad correctamente sujetados para minimizar la probabilidad de accidentes. LA SEGURIDAD PRIMERO. Lea con atención la totalidad de la sección de seguridad de este manual antes de operar el equipo. No permita que nadie opere el equipo sin haber leído y comprendido la totalidad de este manual. Comuníquese con el distribuidor si necesita explicación sobre alguna instrucción que no haya comprendido del todo.

Los cuidados que brinde a su implemento Rhino determinarán en gran medida su satisfacción con el desempeño y la vida útil del equipo. Lea con atención y siga las instrucciones de este manual para comprender cabalmente su nuevo implemento, su uso previsto, y sus requisitos de servicio.

Todas las referencias que se hacen en este manual a derecha, izquierda, frontal, trasero, arriba y abajo corresponden a la perspectiva en el sentido del desplazamiento hacia delante con el implemento correctamente sujetado al tractor.

La información sobre repuestos se encuentra por separado en el Manual de Partes. Las cortadoras Rhino utilizan componentes del sistema equilibrados y coincidentes para porta cuchillas, cuchillas, ejes de corte, hojas, ganchos para hojas, rodillos, componentes de los engrajes, y cojinetes. Estas partes se fabrican y se prueban según las especificaciones de Rhino. Las partes compatibles no genuinas no siempre cumplen con estas especificaciones. El uso de partes no genuinas puede perjudicar el desempeño de la cortadora, anular la garantía y presentar un riesgo para la seguridad. Use partes genuinas Rhino para ahorrar dinero y maximizar la seguridad.

Para referencia futura, registre el número de modelo y el número de serie de RHINO que ha adquirido.

Owner	Fecha de compra:	Serial Number	
Distribuidor	Teléfono	Fecha de compra:	



TW120

CORTADORA/TRITURADORA GIRATORIA

Parte n°. 00762120C

Publicado en 01/11

MANUAL DE OPERADOR

Este Manual del Operador es una parte esencial de la operación segura de esta máquina y se debe mantener con la unidad siempre. LEA, ENTIENDA, y SIGA las instrucciones de Seguridad y Operación contenidas en este manual antes de operar el equipo. C01-Cover

SP

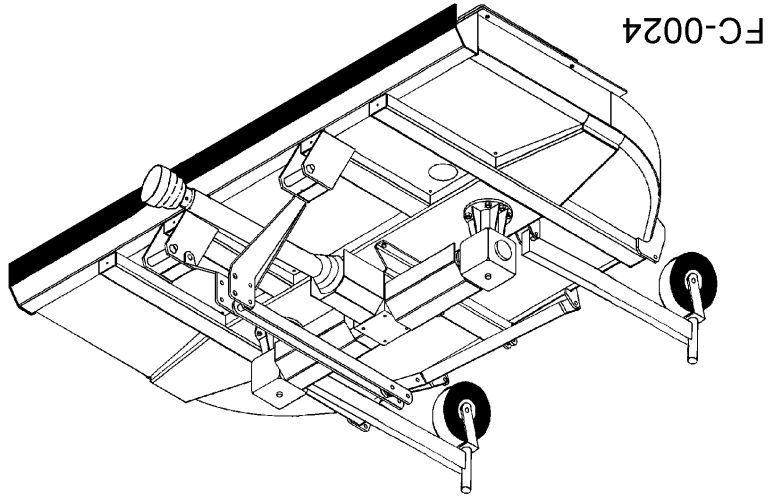
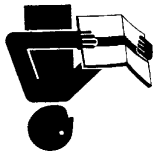

FC-0024

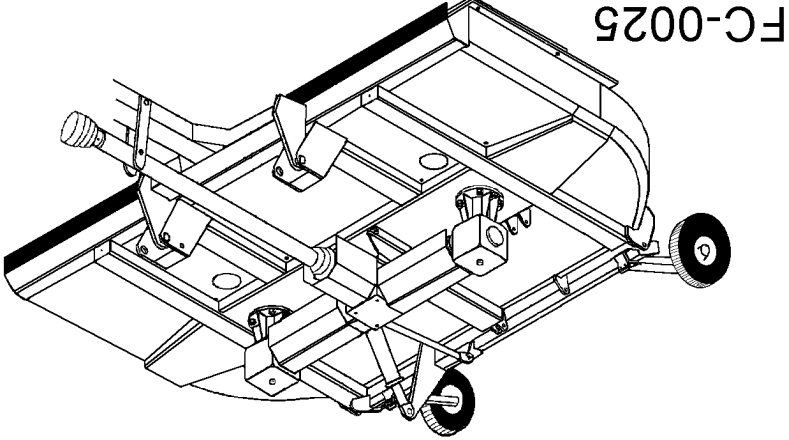

FC-0025

RHINO®

1020 S. Sangamon Ave.
Gibson City, IL 60936
800-446-5158
Email: parts@servis-rhino.com

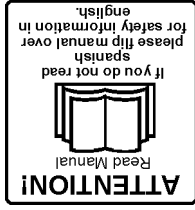

\$0.00

© 2011 Alamo Group Inc.